



MARCUS

Marcus Transformer LTD
 Phone: 1-800-267-7376
 Fax: 1-866-205-7526
 Email: Info@marcustransformer.com

TECHNICAL DATA

SINGLE PHASE CONTROL TRANSFORMER

DESCRIPTION

MODEL	MO250S
Type	Open
VA	250
Primary (Volts)	480
Secondary (Volts)	120
Input /Output Amps	0.52 / 2.08
Temperature Rise	80°C
Insulation Class	B (130°C)
Frequency	60Hz
Polarity	additive
Noise level	less than 40DB
Winding	Copper
Approvals	CE compliant UL listed CSA approved

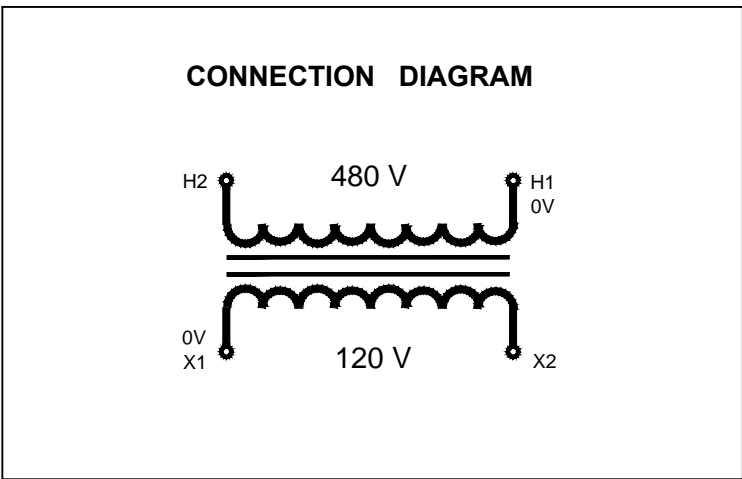

WIRING CONNECTION

PRIMARY :	
VOLTS 480	CONNECT LINES TO : H1-H2
SECONDARY :	
VOLTS 120	CONNECT LINES TO : X1-X2

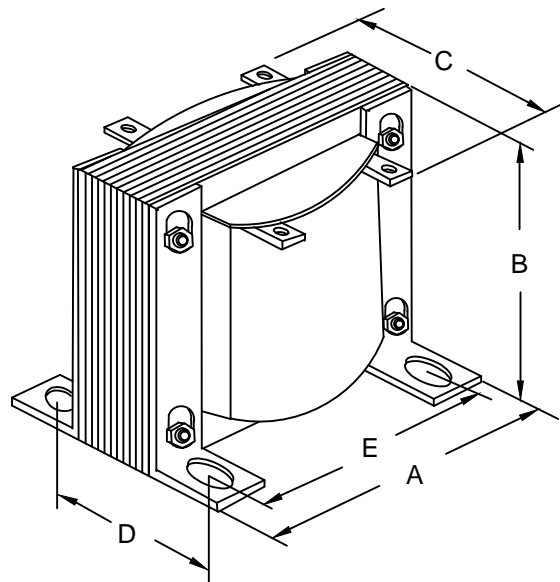

DIMENSIONS INCHES / MM

VA	A	B	C	D	E	MOUNTING HOLES INCHES / MM	SHIP WEIGHT LBS / KG
250	4.50 114.3	3.75 95.3	4.15 105.4	2.75 69.9	3.75 95.3	0.21 x 0.625 5.3 x 15.9	7.50 3.40

Notes: