

Applications:

UNY and UNF unions are installed in threaded thickwall conduit systems:

- UNY – to connect conduit to a conduit fitting, junction box or device enclosure
- UNF – to connect conduit to conduit, or to provide a means for future modification of the conduit system

UNA unions are used in conduit and fitting installations when entrance angle is between 90° and 180°.

EL elbows are installed in conduit run or in box or fitting hub:

- To change direction in threaded rigid conduit run by 90°, or when terminating at a box or fitting

Features:

UNY, UNF and UNL unions have:

- Compact design which permits assembly with a minimum of clearance to other adjacent conduit and/or equipment
- Strong and durable construction

UNA unions:

- Have a single clamping nut on angle, making it both a union and a connector
- Permit conduit joints at angles between 90° and 180°

EL elbows have a smooth interior and are both strong and compact.

Certifications and

Compliances:

- NEC/CEC:

Class I, Division 1 & 2, Groups A, B, C, D

Class II, Division 1, Groups E, F, G

Class II, Division 2, Groups F, G

Class III

EL 1/2", 3/4", 1"

UNF/UNY 105, -215, -205, -305

UNL 105, -125, -215, -205

Class I, Division 1 & 2, Groups B, C, D

Class II, Division 1, Groups E, F, G

Class II, Division 2, Groups F, G

Class III

UNF/UNY406, -506,

-606, -706, -806,

-905, -1005

Class I, Division 1 & 2, Groups C, D

Class II, Division 1, Groups E, F, G

Class II, Division 2, Groups F, G

Class III

EL, UNF, UNL, UNY - all sizes

Class I, Division 1 & 2, Group D

Class II, Division 1, Groups E, F, G

Class II, Division 2, Groups F, G

Class III

UNA

- UL Standard: 886

- CSA Standard: C22.2 No. 30

†See compliances for classification of each product.

Standard Materials:

- UNY, UNF unions – 1/2" to 1" – steel
- UNY, UNF unions – 1 1/4" to 6" – *Feraloy*® iron alloy
- UNL, UNA unions – *Feraloy* iron alloy
- EL elbows – *Feraloy* iron alloy or ductile iron

Standard Finishes:

- Steel – electrogalvanized with chromate treatment
- *Feraloy* iron alloy, malleable iron – electrogalvanized and aluminum acrylic paint

Options:

Description

Copper-free aluminum
Not available on UNA or 5" and 6" UNY/UNF

Suffix SA

UNL

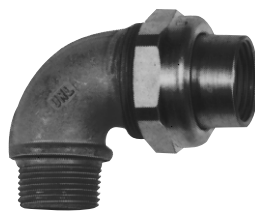

90° Angle

Size	Cat. #
1/2 to 1/2	UNL105
3/4 female to 1/2 male	UNL125
1/2 female to 3/4 male	UNL215
3/4 to 3/4	UNL205

Dimensions

In Inches:

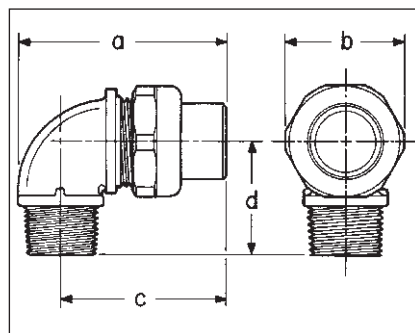

Size	Cat. #	Size	Cat. #
1/2	UNY105	1/2	UNF105
1/2 female to 3/4 male	UNY215	3/4 to 1/2	UNF215
3/4	UNY205	3/4	UNF205
1	UNY305	1	UNF305
1 1/4	UNY405	1 1/4	UNF405
1 1/4	UNY406	1 1/4	UNF406
1 1/2	UNY505	1 1/2	UNF505
1 1/2	UNY506	1 1/2	UNF506
2	UNY605	2	UNF605
2	UNY606	2	UNF606
2 1/2	UNY705	2 1/2	UNF705
2 1/2	UNY706	2 1/2	UNF706
3	UNY805	3	UNF805
3	UNY806	3	UNF806
3 1/2	UNY905	3 1/2	UNF905
4	UNY1005	4	UNF1005
5	UNY012	5	UNF012
6	UNY014	6	UNF014

Size	UNY		UNF	
	Length	Max. Dia.	Length	Max. Dia.
1/2	2 3/8	1 1/2	1 13/16	1 1/2
3/4 - 1/2	2 7/16	1 13/16	1 3/4	1 13/16
3/4	2 1/16	1 13/16	1 3/4	1 13/16
1	2 3/4	1 7/8	2	1 7/8
1 1/4	3 3/16	2 1/4	2 1/4	2 3/4
1 1/2	3 9/16	3 1/16	2 5/8	3 1/16
2	3 3/4	3 13/16	2 9/16	3 3/16
2 1/2	4 5/8	4 5/16	3 3/16	4 5/16
3	5	5 1/16	3 7/16	5 1/16
3 1/2	5 1/2	5 11/16	4 7/8	5 11/16
4	5 5/8	6 3/16	4 7/8	6 3/16
5	5 1/4	8 3/16	3 13/16	8 3/16
6	5 3/8	9 5/16	3 13/16	9 5/16

UNL

Dim.	105	125	215	205
a	2 11/16	2 11/16	2 7/8	2 7/8
b	1 17/32	1 13/16	1 13/16	1 13/16
c	2 1/16	2 1/16	2 1/4	2 1/4
d	1 7/16	1 7/16	1 5/8	1 5/8

Unions and Elbows

Cl. I, Div. 1 & 2, Groups C, D†
 Cl. II, Div. 1, Groups E, F, G
 Cl. II, Div. 2, Groups F, G
 Cl. III

Explosionproof
 Dust-Ignitionproof

5F

5F

UNA

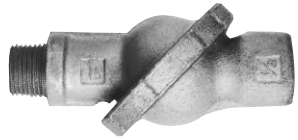

Male (with removable nipple)

Male
 Size

Cat. #

1/2	UNA16
3/4	UNA26
1	UNA36

EL



90° Male



45° Female

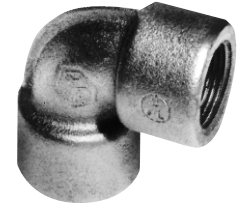

90° Female



90° Male and female

90° Male

Size	Cat. #
1/2	EL195
3/4	EL295
1	EL395

45° Female

Size	Cat. #
1/2	EL1
3/4	EL2
1	EL3
1 1/4	EL4
1 1/2	EL5
2	EL6
2 1/2	EL7
3	EL8
3 1/2	EL9
4	EL10

90° Female

Size	Cat. #
1/2	EL19*
3/4	EL29*
1	EL39*
1 1/4	EL49*
1 1/2	EL59*
2	EL69*
2 1/2	EL79

90° Male and Female

Size	Cat. #
1/2	EL196*
3/4	EL296*
1	EL396*
1 1/4	EL496

*Available in copper free aluminum – add suffix SA to catalog number.

Dimensions In Inches:

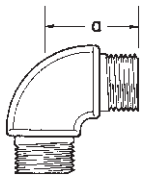

90° Male

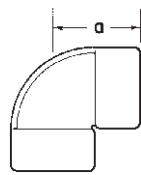

90° Female

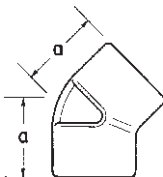

45° Female

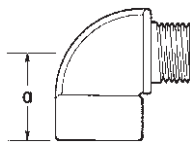

90° Male and female

EL

UNA Male

Size	Length	Width
1/2	4 ⁵ / ₁₆	2 ⁵ / ₈
3/4	4 ¹³ / ₁₆	2 ⁷ / ₈
1	5 ¹ / ₁₆	3 ¹ / ₂

EL

Size	45° Female	90° Male	90° Female	90° Male & Female
	a	a	a	a
1/2	1 ³ / ₁₆	1 ⁷ / ₁₆	1 ¹⁷ / ₃₂	1 ¹⁷ / ₃₂
3/4	1 ³ / ₈	1 ⁵ / ₈	1 ³ / ₄	1 ⁵ / ₈
1	1 ²¹ / ₃₂	1 ⁷ / ₈	2	1 ⁷ / ₈
1 1/4	1 ³ / ₄	2 ¹ / ₄	2 ¹ / ₄	2 ¹ / ₈
1 1/2	1 ⁵ / ₁₆	4	4	
2	2 ¹ / ₄	5	5	
2 1/2	2 ³ / ₄	6 ⁷ / ₁₆	6 ⁷ / ₁₆	
3	3 ¹ / ₈			
3 1/2	3 ⁷ / ₁₆			
4	3 ⁵ / ₈			

†See compliances for classification of each product.