

AR Back Boxes and Accessories for 20, 30, & 60 A Receptacle Housings

Dimensions see pages 1334-1335

ARE

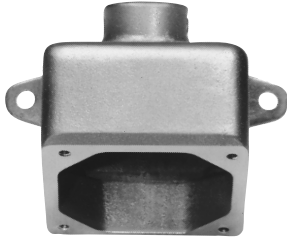

Hub Size	20 / 30 A Cat. #	60 A Cat. #
1/2	ARE13	
3/4	ARE23	
1	ARE33	ARE36
1 1/4		ARE46
1 1/2		ARE56

ARRC

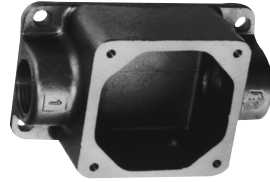

Hub Size	20 / 30 A Cat. #	60 A Cat. #
1/2	ARRC13	
3/4	ARRC23	
1	ARRC33	ARRC36
1 1/4		ARRC46
1 1/2		ARRC56

AR 15° Angle Adapter



For ARRH and ARRC back boxes

For steel panel or cabinet

Mounts On	Takes AR Receptacle Housings	Cat. #
ARRH and ARRC back boxes	20 and 30 amp.	AR30
ARRH and ARRC back boxes	60 amp.	AR60
Steel panel or cabinet	60, 100 and 150 amp.	AR610

ARRH

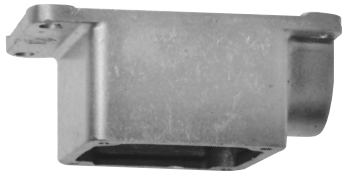

Hub Size	20 / 30 A Cat. #	60 A Cat. #
1/2	ARRH13	
3/4	ARRH23	
1	ARRH33	ARRH36
1 1/4		ARRH46
1 1/2		ARRH56

ARD



Hub Size	20 / 30 A Cat. #	60 A Cat. #
1/2	ARD13	
3/4	ARD23	
1	ARD33	ARD36
1 1/4		ARD46
1 1/2		ARD56

Spring Door Assembly



Used With	Cat. #
30 amp, 2, 3 & 4-pole	QE50
60 amp, 2 & 3-pole	QE51
60 amp, 4-pole	QE52
100 and 150 amp, 2 & 3-pole	QE53
100 and 150 amp, 4-pole	QE54

ARJ

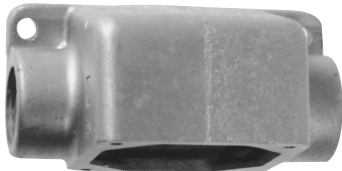

Hub Size	20 / 30 A Cat. #	60 A Cat. #
1/2	ARJ13	
3/4	ARJ23	
1	ARJ33	ARJ36
1 1/4		ARJ46
1 1/2		ARJ56

ARJG

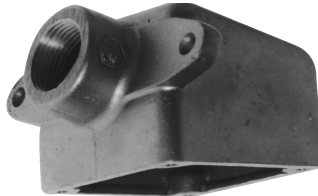

Hub Size	20 / 30 A Cat. #	60 A Cat. #
1/2	ARJG13	
3/4	ARJG23	
1	ARJG33	ARJG36
1 1/4		ARJG46
1 1/2		ARJG56

Cap and Chain



Used With	Cat. #
30 amp, 2, 3 & 4-pole	QE13
60 amp, 2 & 3-pole	QE32
60 amp, 4-pole	QE34
100 and 150 amp, 2 & 3-pole	QE62
100 and 150 amp, 4-pole	QE64

AJ and AJC Back Boxes with Angle Adapters for 60, 100, 200 & 400 A Receptacle Housings AJX Assemblies and Component Parts For 200 and 400 A Receptacle Housings

Dimensions
see pages 1334–1335

1P



AJ Back Box with 60 / 100 / 150 A Angle Adapter



AJ Back Box with 200 / 400 A Angle Adapter

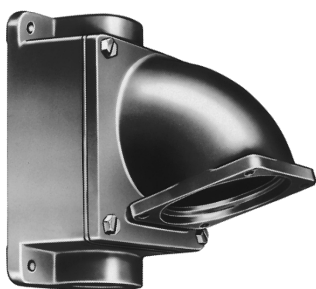

AJC Back Box with 60 / 100 / 150 A AJA Angle Adapter



AJC Back Box with 200 A Angle Adapter

AJX Assemblies Back Box with Angle Adapter, 3 Blank Plates and 1 Hub Plate



Hub Size	400 A Cat. #
2	AJX69
2½	AJX79
3	AJX89
3½	AJX929
4	AJX9210
5	AJX9212

AJX Component Parts

For use in making up assemblies with arrangements of hub plates (4 required) other than those listed.

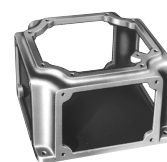

Back Box



Angle Adapter

Type	Cat. #
Back Box 400 A	AJX99
Angle Adapter 400 A	AJ245

AJ and AJC Back Boxes†

		60, 100 & 150 A		200 A		400 A	
Hub Size	Type	Box Only	Box & Adapter Assembly	Box Only	Box & Adapter Assembly	Box Only	Box & Adapter Assembly
1"	One Hub Feed Thru	AJ56* AJC56*	AJ37 AJC37				
1¼"	One Hub Feed Thru	AJ56* AJC56*	AJ47 AJC47				
1½"	One Hub Feed Thru	AJ56* AJC56*	AJ57 AJC57	AJ71*	AJ58		
2"	One Hub Feed Thru	AJ66 AJC66	AJ67 AJC67	AJ71*	AJ68	AJ82*	AJ69‡
2½"	One Hub Feed Thru			AJ71* AJC71	AJ78 AJC78	AJ82*	AJ79‡
3"	One Hub Feed Thru					AJ82*	AJ89‡
Angle Adapter		AJA6		AJA1		AJA2	

*Reducer supplied with assembly.

†AJ and AJC back boxes are square, making it possible to install with hub in several positions.

‡Use AJ69, AJ79 or AJ89 for cables up to 2 – #350MCM, 3 – #300MCM or 4 – #250MCM. For larger cables, use AJX69, etc., listed under assemblies.



Hub Plate



Blank Plate

Hub Size	Hub Plate 400 A Cat. #	Blank Plate 400 A Cat. #
2	YYP96	YYP900
2½	YYP97	
3	YYP98	
3½	YYP99	
4	YYP910	
5	YYP9012	

1P Back Boxes

Dimensions

Dimensions (In Inches): ARE Back Boxes

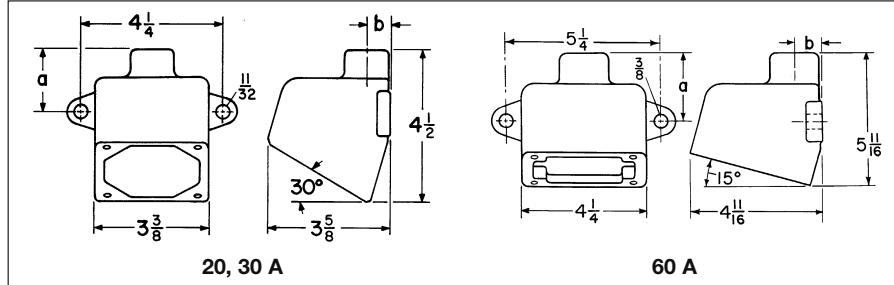

Cat. #	Rating	Size	a	b
13	20, 30 A	1/2	1 ²⁷ / ₃₂	1 ¹¹ / ₁₆
23	20, 30 A	3/4	1 ²⁷ / ₃₂	1 ¹³ / ₁₆
33	20, 30 A	1	1 ³¹ / ₃₂	1 ¹⁵ / ₁₆
36	60 A	1	2 ⁹ / ₁₆	1 ¹⁵ / ₁₆
46	60 A	1 1/4	2 ⁵ / ₈	1 ³ / ₁₆
56	60 A	1 1/2	2 ¹¹ / ₁₆	1 ⁵ / ₁₆

ARJG Back Boxes

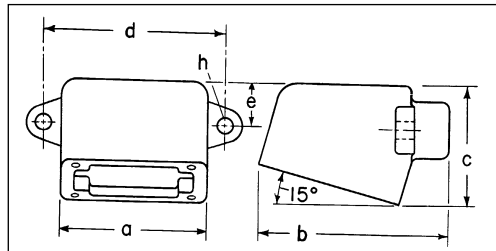

Cat. #	Rating	Size	a	b	c	d	e	h Dia.
13	20, 30 A	1/2	3 ³ / ₈	4 ¹⁵ / ₃₂	2 ³ / ₄	4 ¹ / ₄	1 ³ / ₈	1 ¹¹ / ₃₂
23	20, 30 A	3/4	3 ³ / ₈	4 ¹⁵ / ₃₂	2 ³ / ₄	4 ¹ / ₄	1 ³ / ₈	1 ¹¹ / ₃₂
33	20, 30 A	1	3 ³ / ₈	4 ¹⁹ / ₃₂	2 ³ / ₄	4 ¹ / ₄	1 ³ / ₈	1 ¹¹ / ₃₂
36	60 A	1	4 ¹ / ₄	5 ⁵ / ₈	4 ¹¹ / ₁₆	5 ¹ / ₄	1 ⁵ / ₈	3 ³ / ₈
46	60 A	1 1/4	4 ¹ / ₄	5 ¹ / ₁₆	4 ¹ / ₁₆	5 ¹ / ₄	1 ⁵ / ₈	3 ³ / ₈
56	60 A	1 1/2	4 ¹ / ₄	5 ³ / ₄	4 ¹ / ₁₆	5 ¹ / ₄	1 ⁵ / ₈	3 ³ / ₈

AJ and AJC With 60, 100, 150, 200 and 400 Ampere Angle Adapters

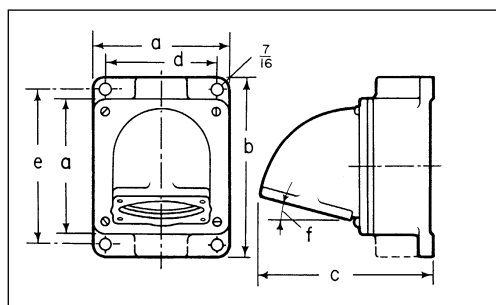

Cat. #	Rating	Size	a	b	c	d	e	f
37, 47, 57	60, 100 A	1, 1 1/4, 1 1/2	5 ⁵ / ₈	8	7 ⁷ / ₁₆	4 ⁷ / ₈	7	15°
67	60, 100 A	2	5 ⁵ / ₈	8	8	4 ⁷ / ₈	7	15°
58, 68, 78	200 A	1 1/2, 2, 2 1/2	8	10 ³ / ₄	9 ⁷ / ₈	6 ³ / ₄	9 ¹ / ₂	45°
69, 79, 89	400 A	2, 2 1/2, 3	9	11 ⁵ / ₈	11 ¹³ / ₁₆	7 ³ / ₄	10 ⁵ / ₈	45°

AJX Back Body - 400 Amperes

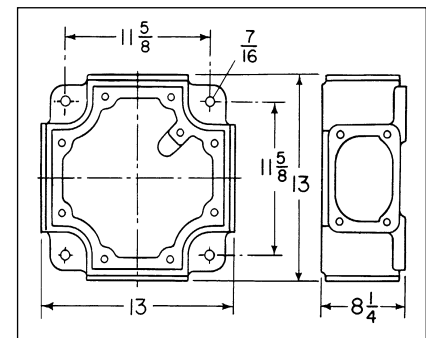

Hub Plate - 400 Amperes

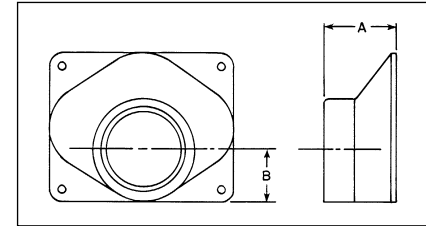

Cat. #	Hub Size	"A"	"B"
YYP96	2	3 ³ / ₄	1 ¹¹ / ₁₆
YYP97	2 1/2	3 ³ / ₈	2 ⁵ / ₁₆
YYP98	3	3 ³ / ₈	2 ⁵ / ₁₆
YYP99	3 1/2	3 ³ / ₈	2 ⁹ / ₁₆
YYP910	4	3 ³ / ₈	2 ¹³ / ₁₆
YYP9012	5	4 ⁵ / ₈	3 ⁷ / ₁₆

AJ Angle Adapter

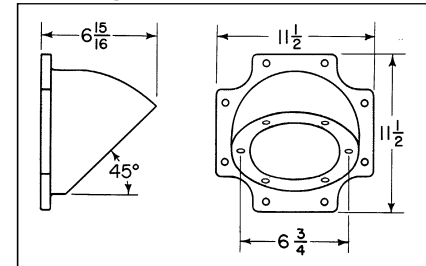

Dimensions

ARRC and ARRH Back Boxes

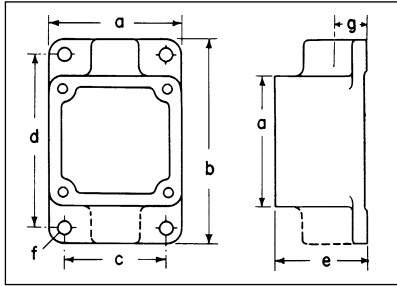

Cat. #	Rating	Size	a	b	c	d	e	f Dia.	g
13	20 / 30 A	1/2	3 3/8	5 5/16	2 5/8	4 9/16	2 1/4	1 1/32	1 1/16
23	20 / 30 A	3/4	3 3/8	5 5/16	2 5/8	4 9/16	2 1/4	1 1/32	1 3/16
33	20 / 30 A	1	3 3/8	5 5/16	2 5/8	4 9/16	2 1/4	1 1/32	1 5/16
36	60 A	1	4 1/4	6 1/2	3 1/2	5 3/4	3 3/8	7/16	1 3/8
46	60 A	1 1/4	4 1/4	6 1/2	3 1/2	5 3/4	3 3/8	7/16	1 3/8
56	60 A	1 1/2	4 1/4	6 1/2	3 1/2	5 3/4	3 3/8	7/16	1 3/8

ARD Back Boxes

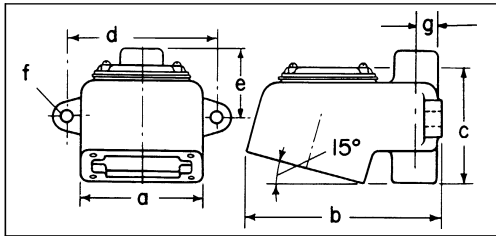

Cat. #	Rating	Size	a	b	c	d	e	f Dia.	g
13	20 / 30 A	1/2	3 3/8	5 5/16	3 23/32	4 1/4	1 27/32	1 1/32	1 1/16
23	20 / 30 A	3/4	3 3/8	5 5/16	3 23/32	4 1/4	1 27/32	1 1/32	1 3/16
33	20 / 30 A	1	3 3/8	5 5/16	3 23/32	4 1/4	1 27/32	1 1/32	1 5/16
36	60 A	1	4 1/4	7 1/16	5 3/4	5 1/8	2 3/4	3/8	1 5/16
46	60 A	1 1/4	4 1/4	7 1/16	5 3/4	5 1/8	2 3/4	3/8	1 5/16
56	60 A	1 1/2	4 1/4	7 1/16	5 3/4	5 1/8	2 3/4	3/8	1 5/16

ARJ Back Boxes

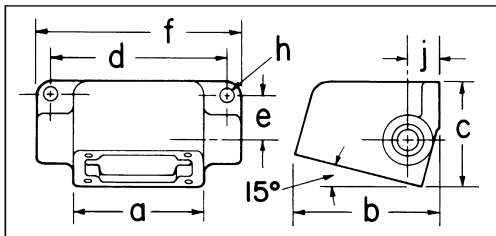

Cat. #	Rating	Size	a	b	c	d	e	f	h Dia.	j
13	20 / 30 A	1/2	3 3/8	3 5/8	2 3/4	4 5/8	1 7/32	5 5/16	1 1/32	1 5/16
23	20 / 30 A	3/4	3 3/8	3 5/8	2 3/4	4 5/8	1 7/32	5 5/16	1 1/32	1 5/16
33	20 / 30 A	1	3 3/8	3 5/8	2 3/4	4 5/8	1 7/32	5 5/16	1 1/32	1 5/16
36	60 A	1	4 1/4	4 11/16	4 11/16	5	1 23/32	6 3/8	3/8	1 5/16
46	60 A	1 1/4	4 1/4	4 11/16	4 11/16	5	1 23/32	6 3/8	3/8	1 5/16
56	60 A	1 1/2	4 1/4	4 11/16	4 11/16	5	1 23/32	6 3/8	3/8	1 5/16

AR30 and AR60 Angle Adapters

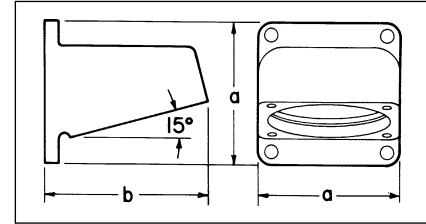

Cat. #	Rating	a	b
AR30	20 / 30 A	3 3/8	4 1/8
AR60	60 A	4 1/4	4 15/16

AR610 Angle Adapter

