

Nova T☆ Controls

This series of classic thin-profile linear-slide dimmers and switches offers the following standard features:

- Square Law Dimming
- Voltage compensation
- Power-failure memory
- Superior RFI suppression
- Captive linear slider
- Accessible air-gap switch
- Electrostatic discharge tested
- Precise color matching
- Heavy-duty components for surge protection and long product life

Product Family Features

- Available for 120 – 277~ line voltage switching (sink only control) 0-10 V_{DC} LED drivers and ballasts (power pack not required for loads up to 8 A)
- Excellent for residential or commercial applications
- Intuitive operation—easy to use
- Slide-to-off and preset models available
- Enclosed heat sink for aesthetically pleasing appearance
- Multigang alignment for quick and easy installation
- Full family of products for most lighting sources, plus matching accessories and wallplates
- Rated at 120 V~ 60 Hz, unless noted otherwise
- Custom products (CPN) are available to meet specific customer needs. Please contact Lutron® Customer Service at 888.588.7661 for availability.

Regulatory Approvals

- UL
- CSA
- NOM

Colors and Finishes

When ordering product for use with metal wallplates, the product and wallplate must be ordered separately. See the Architectural Wallplates and Accessories section of Volume 1: Basic Devices and Single-Space Systems Catalog (P/N 367-1746) for ordering procedure. See right for complete list of metal finishes.

Custom color matching is available for all Nova T☆ products. A swatch or sample is all that is required. Call customer service to arrange for a color-matched control. Engraving is available for all Nova T☆ products. Engraving schedules are available at www.lutron.com/engraving or through Customer Service at 888.588.7661.



Slide-to-Off Controls
Select light level with slider;
slide down to off



Preset Controls
Select light level with slider;
press on/off

Available Colors and Finishes

Matte Finishes

Add color/finish suffix to model number to order.
Example: NT-600-**WH**

WH	White	GR	Gray
BE	Beige	TP	Taupe
IV	Ivory	SI	Sienna
AL	Almond	BR	Brown
LA	Light Almond	BL	Black

Special Order

Add color/finish suffix to model number to order.
Example: NT-600-**BB**

Metal Finishes

SB Satin Brass BB Bright Brass

BC Bright Chrome

Special Metal Finishes

QB Antique Brass QZ Antique Bronze

SC Satin Chrome SN Satin Nickel

BN Bright Nickel

Anodized Aluminum Finishes

CLA Clear BLA Black

BRA Brass

Job Name:	Model Numbers:
Job Number:	

Dimensions

Dimensions are shown as: in (mm).

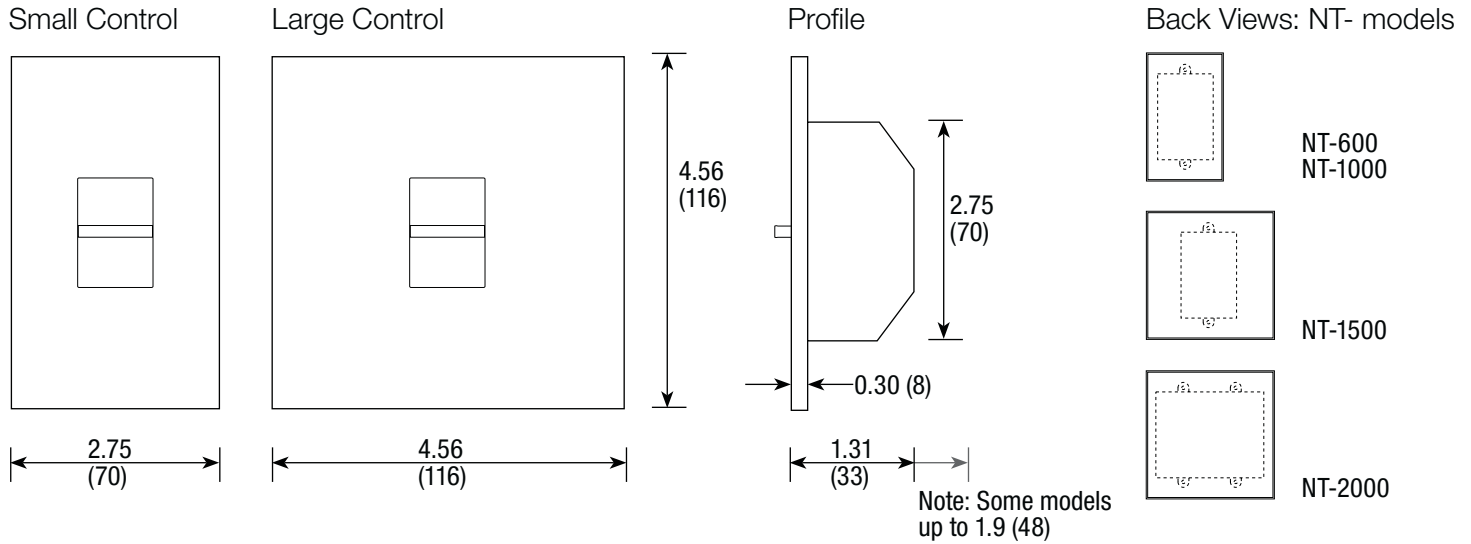

Available Controls and Accessories (Summary)

For specific uses, capacities, and model numbers, see the following pages.

Slide-to-Off Dimmers

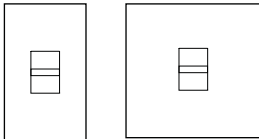

Small Control Large Control

Preset Dimmers

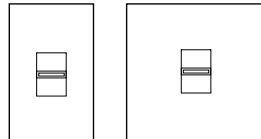

Small Control Large Control

Linear-Slide Switches

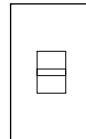

Small Control

Slide-to-Off Fan-Speed Controls

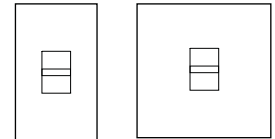

Small Control Large Control

Receptacles and Plugs

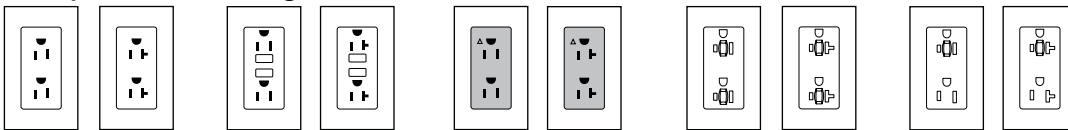

15 A Receptacles 20 A Receptacles 15 A GFCI Receptacles 20 A GFCI Receptacles 15 A Isolated Ground Receptacles 20 A Isolated Ground Receptacles 15 A Duplex for Dimming Use 20 A Duplex for Dimming Use 15 A Half for Dimming Use 20 A Half for Dimming Use

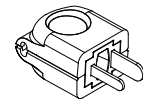

10 A Replacement Plug for Dimming Use



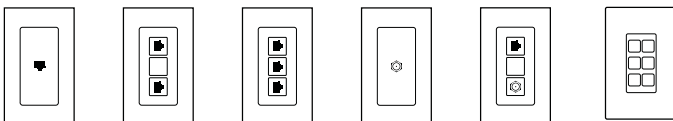







Jacks and Ports



Single Telephone Double Telephone Triple Telephone Cable TV Telephone/Cable TV 6-Port Frame

Job Name:	Model Numbers:
Job Number:	









Control Specifications

 Incandescent Dimmers: Slide-to-Off			
	Description	Maximum Capacity	Model Number
 Small Control	Single pole 120 V~ 60 Hz	600 W	NT-600-XX
	Single pole 120 V~ 60 Hz	1000 W	NT-1000-XX
 Large Control	Single pole 120 V~ 60 Hz	1500 W	NT-1500-XX
	Single pole 120 V~ 60 Hz	1950 W	NT-2000-XX
The NT-2000-XX does not have removable side sections; it can be ganged but must be kept intact. The NT-2000-XX requires a 2-gang wallbox.			
 Incandescent Dimmers: Preset			
	Description	Maximum Capacity	Model Number
 Small Control	Single pole/3-way/4-way 120 V~ 60 Hz	600 W	NT-603P-XX
	Single pole/3-way/4-way 120 V~ 60 Hz	1000 W	NT-1003P-XX
 Large Control	Single pole/3-way/4-way 120 V~ 60 Hz	1500 W	NT-1503P-XX
For 3-way or 4-way switching, use NT-3PS-XX (3-way), NT-4PS-XX (4-way), or other mechanical switches.			
 Electronic Low-Voltage (ELV) Dimmers: Slide-to-Off			
	Description	Maximum Capacity	Model Number
 Small Control	Single pole 120 V~ 60 Hz	300 W	NTELV-300-XX
	Single pole 120 V~ 60 Hz	600 W	NTELV-600-XX
Maximum capacity is permitted lamp wattage. Requires neutral wire connection. For larger capacity ELV loads (up to 1000 W), use Nova T☆ fluorescent dimmers (NTF-10-XX or NTF-103P-XX) with an PHPM-WBX interface.			
 Magnetic Low-Voltage (MLV) Dimmers: Slide-to-Off			
	Description	Maximum Capacity	Model Number
 Small Control	Single pole 120 V~ 60 Hz	600 VA / 450 W	NTLV-600-XX
	Single pole 277 V~ 60 Hz	600 VA / 450 W	NTLV-600-277-XX
	Single pole 120 V~ 60 Hz	1000 VA / 800 W	NTLV-1000-XX
	Single pole 277 V~ 60 Hz	1000 VA / 800 W	NTLV-1000-277-XX
 Large Control	Single pole 120 V~ 60 Hz	1500 VA / 1200 W	NTLV-1500-XX
Maximum capacity is permitted lamp wattage. 277 V~ models require neutral wire connection.			

(continued on next page)

Job Name:	Model Numbers:
Job Number:	











Control Specifications (continued)

 Magnetic Low-Voltage (MLV) Dimmers: Preset					
	Small Control	Description	Maximum Capacity	Model Number	
		Single pole/3-way/4-way 120 V~ 60 Hz	600 VA / 450 W	NTLV-603P-XX	
		Single pole/3-way/4-way 120 V~ 60 Hz	1000 VA / 800 W	NTLV-1003P-XX	
	Large Control	Single pole/3-way/4-way 120 V~ 60 Hz	1500 VA / 1200 W	NTLV-1503P-XX	
For 3-way or 4-way switching, use NT-3PS-XX (3-way), NT-4PS-XX (4-way), or other mechanical switches.					
 Fluorescent Dimmers for Lutron® 3-wire fluorescent ballasts or LED drivers: Slide-to-Off					
	Small Control	Description	Maximum Capacity	Model Number	
		Single pole 120 V~ 60 Hz	16 A	NTF-10-XX	
		Single pole 277 V~ 60 Hz	8 A	NTF-10-277-XX	
Use with Lutron® 3-wire fluorescent ballasts or LED drivers only. For LED loads, please see the "Report Cards" at www.lutron.com/hilumeled for proper loading of the dimmer. No derating required. To determine the number of ballasts that can be controlled by Nova T☆ fluorescent dimmer, divide the control capacity by the ballast current. For a complete list of Lutron® ballasts and ballast currents, see the Fluorescent Dimming System Selection Guide (P/N 366002) at www.lutron.com .					
 Fluorescent Dimmers for Lutron® 3-wire fluorescent ballasts or LED Drivers: Preset					
	Small Control	Description	Maximum Capacity	Model Number	
		Single pole/3-way 120 V~ 60 Hz	8 A	NTF-103P-XX	
		Single pole/3-way 277 V~ 60 Hz	6 A	NTF-103P-277-XX	
Use with Lutron® 3-wire fluorescent ballasts or LED drivers only. For LED loads, please see the "Report Cards" at www.lutron.com/hilumeled for proper loading of the dimmer. For 3-way or 4-way switching, use NT-3PS-XX (3-way), NT-4PS-XX (4-way), or other mechanical switches. No derating required. To determine the number of ballasts that can be controlled by Nova T☆ fluorescent dimmer, divide the control capacity by the ballast current. For a complete list of Lutron® ballasts and ballast currents, see the Fluorescent Dimming System Selection Guide (P/N 366002) at www.lutron.com .					
0-10 V^{DC} Dimmers for Electronic Ballasts or LED Drivers: Slide-to-Off					
	Small Control	Description	Maximum Capacity*		Model Number
			Load	0-10 V ^{DC} Sink	
		Single pole 0-10 V ^{DC} 120-277 V~	8 A	30 mA	NTSTV-DV-XX
Power pack not required for loads up to 8 A. May use Lutron® power pack (model PP-120H, PP-277H, or PP347H; see Lutron® P/N 369544) for higher load current applications or for Class 2 installations. Compatible with any IEC 60929 annex E compliant LED drivers and ballasts. Refer to LED driver and ballast manufacturer's specification for 0-10 V ^{DC} sink currents. Control has a high and low end trim to adjust the 0 - 10 V ^{DC} output for optimal dimming performance. * Limited by whichever rating is achieved first.					

(continued on next page)

Job Name:	Model Numbers:
Job Number:	







Control Specifications (continued)

 Fluorescent Dimmers for Tu-Wire® Electronic Ballasts: Slide-to-Off			
	Description	Maximum Capacity	Model Number
 Small Control	Single pole 120 V~ 60 Hz	5 A	NTFTU-5A-XX
	Single pole 277 V~ 60 Hz	5 A	NTFTU-5A-277-XX
Use with Lutron® Tu-Wire® line voltage control electronic dimming ballasts only. To determine the number of ballasts that can be controlled by Nova T☆ fluorescent dimmer, divide the control capacity by the ballast current. For a complete list of Lutron® ballasts and ballast currents, see the Fluorescent Dimming System Selection Guide (P/N 366002) at www.lutron.com. Compatible with Advance® Mark X® and Sylvania Powersense® ballasts.			
 Fluorescent Dimmers for Advance® Mark X® VEZ series 277 V~ Ballasts: Preset			
	Description	Maximum Capacity	Model Number
 Small Control	3-way 277 V~ 60 Hz	3 A	NTFTU-3AP-277-XX-CPW0196
For control of permanently installed Advance® Mark X® VEZ series 277 V~ ballasts only. Install on load side only. No derating required. To determine the number of ballasts that can be controlled by Nova T☆ fluorescent dimmer, divide the control capacity by the ballast current. For a complete list of Lutron® ballasts and ballast currents, see the Fluorescent Dimming System Selection Guide (P/N 366002) at www.lutron.com.			
Linear-Slide Switches for General Purpose: All Sources and Motor Loads			
	Description	Maximum Capacity	Model Number
 Small Control	Single pole 120 V~ 60 Hz	20 A	NT-1PS-XX
	3-way 120 V~ 60 Hz	20 A	NT-3PS-XX
	4-way 120 V~ 60 Hz	20 A	NT-4PS-XX
No derating required.			
 Fan-Speed Controls: Quiet			
	Description	Maximum Capacity	Model Number
 Small Control	Single pole, 3-speed 120 V~ 60 Hz	1.5 A	NTFSQ-XX
For use with one ceiling paddle fan. No derating required.			
 Fan-Speed Controls: Fully Variable			
	Description	Maximum Capacity	Model Number
 Small Control	Single pole, Adjustable minimum speed 120 V~ 60 Hz	6 A	NTFS-6E-XX
 Large Control	Single pole, Adjustable minimum speed 120 V~ 60 Hz	12 A	NTFS-12E-XX
For use with one or more ceiling, ventilation, or exhaust fans. Do not mix fan types on same control.			

Advance and Mark X are registered trademarks of Phillips Corporation.
 Powersense is a registered trademark of Sylvania Corporation.

Job Name:	Model Numbers:
Job Number:	











Accessory Specifications

Receptacles and Plugs			
	Description	Maximum Capacity	Model Number
		Receptacle	15 A 125 V~
20 A 125 V~			NTR-20-XX
Tamper Resistant Receptacle		15 A 125 V~	NTR-15-TR-XX
		20 A 125 V~	NTR-20-TR-XX
No derating required.			
	Description	Maximum Capacity	Model Number
	Tamper Resistance GFCI Receptacle	15 A 125 V~	NTR-15-GFTR-XX
20 A 125 V~		NTR-20-GFTR-XX	
Insert is permanently attached to the back cover. No derating required.			
	Description	Maximum Capacity	Model Number
	Isolated Ground Receptacle	15 A 125 V~	NTR-15-IG-OR-XX
20 A 125 V~		NTR-20-IG-OR-XX	
Insert is orange; wallplate is color selected. Receptacles can be special-ordered to match wallplate color; contact Lutron® Customer Service at 888.588.7661 or visit www.lutron.com . No derating required.			
	Description	Maximum Capacity	Model Number
	Tamper Resistant Duplex for Dimming Use	15 A 125 V~	NTR-15-DDTR-XX
20 A 125 V~		NTR-20-DDTR-XX	
Insert is permanently attached to the back cover. No derating required.			
	Description	Maximum Capacity	Model Number
	Tamper Resistant Half for Dimming Use	15 A 125 V~	NTR-15-HDTR-XX
20 A 125 V~		NTR-20-HDTR-XX	
Insert is permanently attached. No derating required.			
	Description	Maximum Capacity	Model Number
	Replacement Plug for Dimming Use	10 A 125 V~	RP-FDU-10-XX

(continued on next page)







Job Name:	Model Numbers:
Job Number:	

Accessory Specifications (continued)

Accessory Type	Description	Model Number	
	Single Telephone Jack	6-conductor RJ11 Also accepts most 4-conductor plugs	NT-PJ-XX
	Cable TV Jack	F-style 75 Ohm coaxial cable	NT-CJ-XX
No derating required for any cable jack configurations. A physical barrier (partition) must exist when ganging with any line-voltage products.			
	Field Customizable 6-port frame	Ships with 6 blank ports. Use with connectors shown below. Each connector fills 1 port.	NT-6PF-XX
	Telephone Jack Connector	6-conductor RJ11 Category 3	CON-1P-C3-WH
		8-conductor RJ45 Category 5e	CON-1P-C5E-WH
		8-conductor RJ45 Category 6	CON-1P-C6-WH
	Fiber Jack Connector	MT-RJ feed-through	CON-1F-MTRJ-WH
	Fiber Jack Connector	SC simplex	CON-1F-SC-WH
	Fiber Jack Connector	LC non-flush mount	CON-1F-LC-WH
	Fiber Jack Connector	ST style	CON-1F-ST-WH
	Cable Jack Connector	F-style 75 Ohm coaxial cable	CON-1C-WH
	BNC Jack Connector	BNC connector	CON-1B-WH

Job Name:	Model Numbers:
Job Number:	

Wallplate Specifications

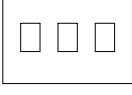
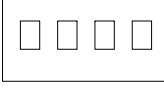

Wallplate Images	Description	Dimensions (w x h)	Model Number
	Single gang: For 1 small control (provided with control)	2.75 in x 4.56 in (70 mm x 116 mm)	VWP-1-XX
	Single gang: For 1 accessory	2.75 in x 4.56 in (70 mm x 116 mm)	VWP-R-XX
	2 Gang: For 2 small controls	4.56 in x 4.56 in (116 mm x 116 mm)	VWP-2-XX
	2 Gang: For 2 accessories	4.56 in x 4.56 in (116 mm x 116 mm)	VWP-2R-XX
	2 Gang: For 1 small control (left) and 1 accessory (right)	4.56 in x 4.56 in (116 mm x 116 mm)	VWP-2CR-XX
	2 Gang: For 1 accessory (left) and 1 small control (right)	4.56 in x 4.56 in (116 mm x 116 mm)	VWP-2RC-XX
	3 Gang: For 3 small controls	6.32 in x 4.56 in (161 mm x 116 mm)	VWP-3-XX
	4 Gang: For 4 small controls	8.45 in x 4.56 in (215 mm x 116 mm)	VWP-4-XX

For other configurations, including small controls, large controls, and accessories, refer to the Specification Guide on the Dimmers & Switches product page at www.lutron.com, or call Lutron® Customer Service at 888.588.7661 for assistance.

For other faceplates, see the Lutron Custom Architectural Multi-gang tool at:
<http://www.lutron.com/en-US/service-support/Pages/technical/design-selectiontools/multigang.aspx>

Job Name:	Model Numbers:
Job Number:	

Derating: Maximum Capacities in Multigang Installations

 Single Units Full capacity No side sections removed		 End Units One side section removed		 Middle Units Two side sections removed	
Incandescent Controls					
600 W		500 W		300 W	
1000 W		900 W		700 W	
1500 W		1250 W		1000 W	
1950 W		—		—	
NT-2000-XX controls (for 1950 W capacity) must be ganged without removing side sections.					
Electronic Low-Voltage (ELV) Controls					
300 W		300 W		250 W	
600 W		500 W		400 W	
Permitted lamp wattage for ELV controls.					
Magnetic Low-Voltage (MLV) Controls					
600 VA/450 W		500 VA/400 W		300 VA / 250 W	
1000 VA/800 W		900 VA/750 W		700 VA / 500 W	
1500 VA/1200 W		1250 VA/1000 W		1000 VA / 800 W	
Permitted lamp wattage for MLV controls.					
Fluorescent 3-Wire Ballast or LED Driver Controls					
6 A		No derating required			
8 A		No derating required			
16 A		No derating required			
Fluorescent Tu-Wire® Controls					
3 A		No derating required			
5 A		4 A		3.3 A	
0-10 V^{DC} Electronic Ballast or LED Driver Controls					
Load	0-10 V^{DC} Sink	No derating required			
8 A	30 mA				
Quiet Fan-Speed Controls					
1.5 A		No derating required			
Fully Variable Fan-Speed Controls					
6 A		4.2 A		2.5 A	
12 A		10 A		8.3 A	

Job Name:	Model Numbers:
Job Number:	

Wiring Diagrams: Single Location

Single-Pole

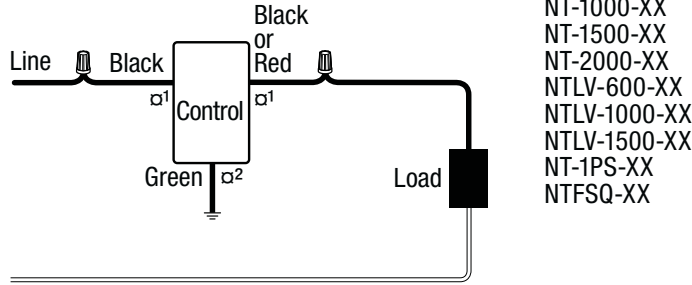

NT-600-XX
NT-1000-XX
NT-1500-XX
NT-2000-XX
NTLV-600-XX
NTLV-1000-XX
NTLV-1500-XX
NT-1PS-XX
NTFSQ-XX

Neutral

- Ground
- Wire connector

α1 Brass screw terminal
α2 Green screw terminal
Note: Controls will have either screw terminals or wires.

Fan

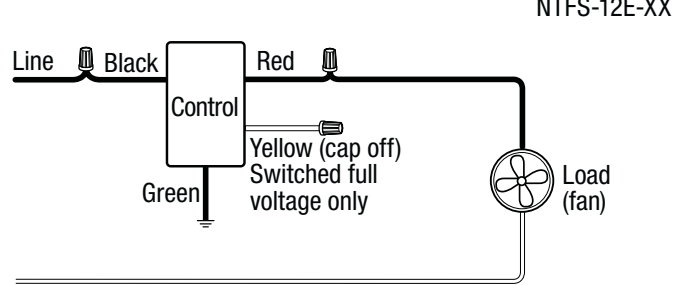

NTFS-6E-XX
NTFS-12E-XX

Neutral

- Ground
- Wire connector

3-Way Control

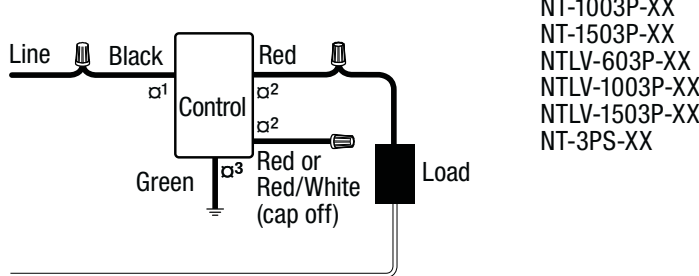

NT-603P-XX
NT-1003P-XX
NT-1503P-XX
NTLV-603P-XX
NTLV-1003P-XX
NTLV-1503P-XX
NT-3PS-XX

Neutral

- Ground
- Wire connector

α1 Copper/Black screw terminal
α2 Brass screw terminal
α3 Green screw terminal
Note: Controls will have either screw terminals or wires.

Fan/Light

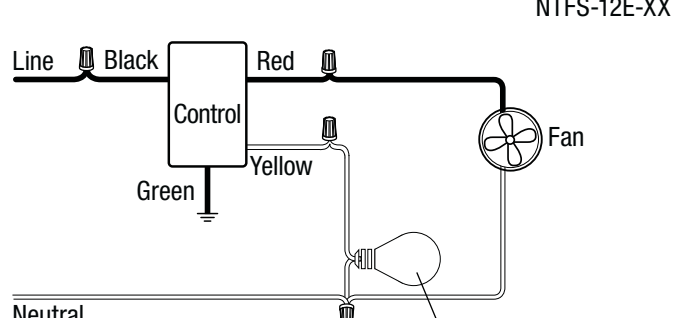

NTFS-6E-XX
NTFS-12E-XX

Neutral

- Ground
- Wire connector

With Neutral

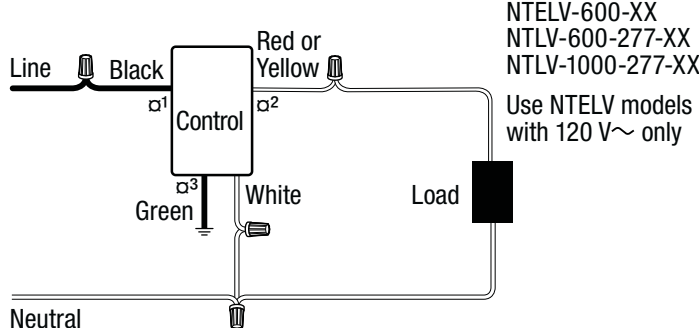

NTELV-300-XX
NTELV-600-XX
NTLV-600-277-XX
NTLV-1000-277-XX
Use NTELV models with 120 V~ only

Neutral

- Ground
- Wire connector

α1 Copper/Black screw terminal
α2 Brass screw terminal
α3 Green screw terminal
Note: Controls will have either screw terminals or wires.

Job Name:	Model Numbers:
Job Number:	

Wiring Diagrams: Multi-Location

3-Way

Control Line Side

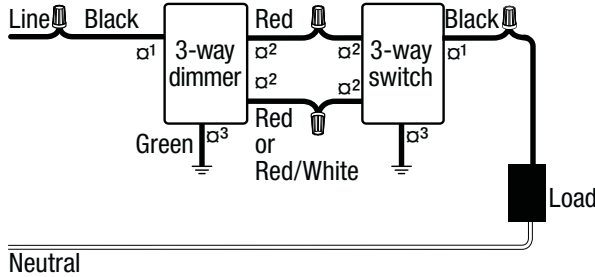

Control Load Side

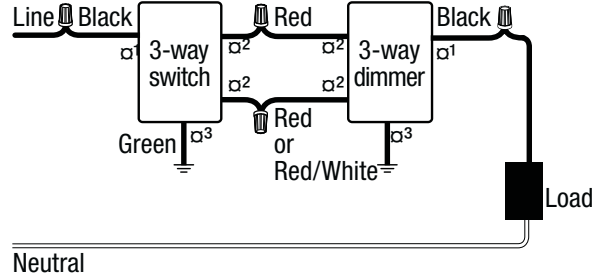

NT-603P-XX
 NT-1003P-XX
 NT-1503P-XX
 NTLV-603P-XX
 NTLV-1003P-XX
 NTLV-1503P-XX
 NT-3PS-XX

- Ground
 - Wire connector
 - α1 Copper/Black screw terminal
 - α2 Brass/Gold screw terminal
 - α3 Green screw terminal
- Note:** Controls will have either screw terminals or wires.

4-Way

Control Line Side

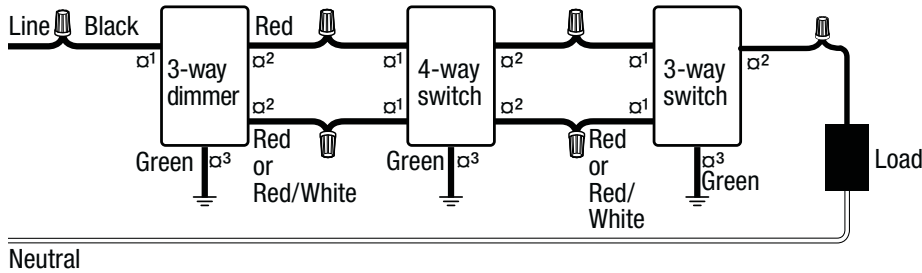

NT-603P-XX
 NT-1003P-XX
 NT-1503P-XX
 NTLV-603P-XX
 NTLV-1003P-XX
 NTLV-1503P-XX
 NT-3PS-XX
 NT-4PS-XX

Control Load Side

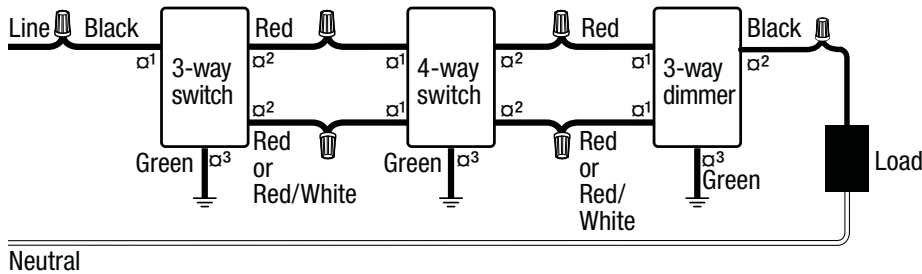

- Ground
 - Wire connector
 - α1 Copper/Black screw terminal
 - α2 Brass/Gold screw terminal
 - α3 Green screw terminal
- Note:** Controls will have either screw terminals or wires.

Job Name:	Model Numbers:
Job Number:	

Wiring Diagrams: Accessories

Cable TV Jack

NT-CJ-XX

Cable TV Jack

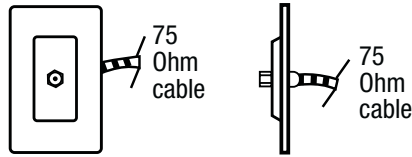

6-Conductor Telephone Jack (accepts most 4-conductor jacks)

NT-PJ-XX

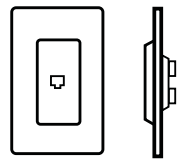

Jack position	Wire color
1	White
2	Black
3	Red
4	Green
5	Yellow
6	Blue

Receptacle

NTR-15-XX
NTR-20-XX
NTR-15-IG-OR-XX
NTR-20-IG-OR-XX
NTR-15-TR-XX
NTR-20-TR-XX

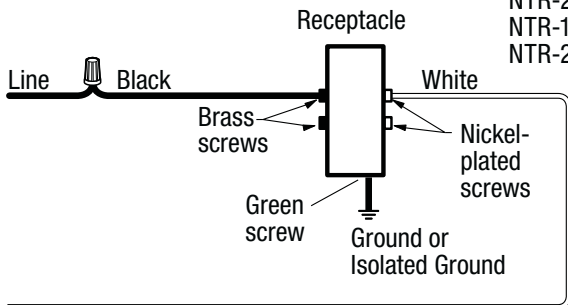

Neutral

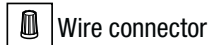

Tamper Resistant GFCI Receptacle

NTR-15-GFTR-XX
NTR-20-GFTR-XX

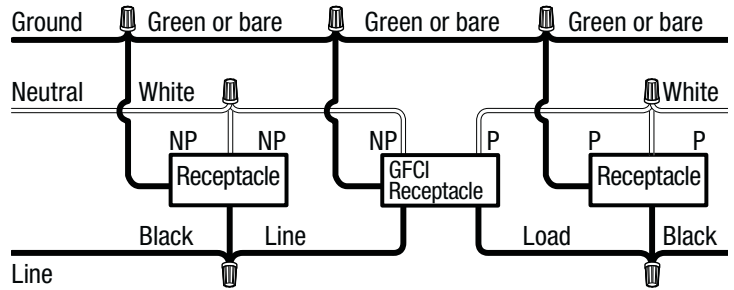

Wire connector
P: Protected
NP: Not Protected

Tamper Resistant Dimmable Receptacle (Dual)

NTR-15-DDTR-XX
NTR-20-DDTR-XX

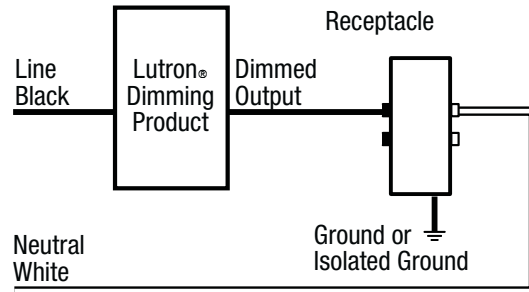

Tamper Resistant Dimmable Receptacle (Half)

NTR-15-HDTR-XX
NTR-20-HDTR-XX

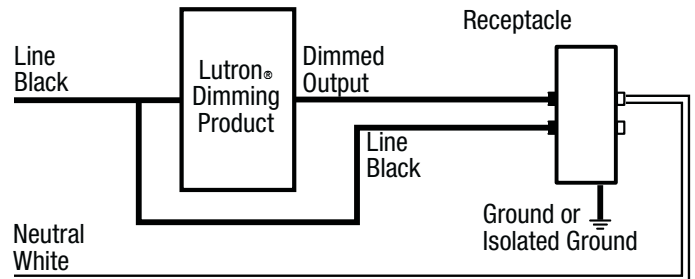

Job Name:	Model Numbers:
Job Number:	

Wiring Diagrams: NTF- Controls

Single-Pole

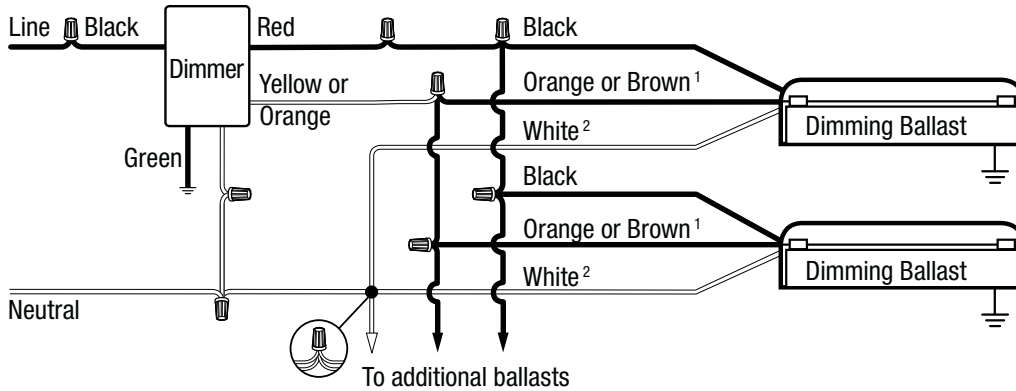

- Ground
 - Wire connector
 - Typical 4-wire connection
- NTF-10-XX
NTF-10-277-XX

¹Yellow/Blue or Yellow/Green when used with magnetic dimming ballasts
²Must use lamp disconnect sockets with magnetic dimming ballasts

Single-Pole: 3-Way Control

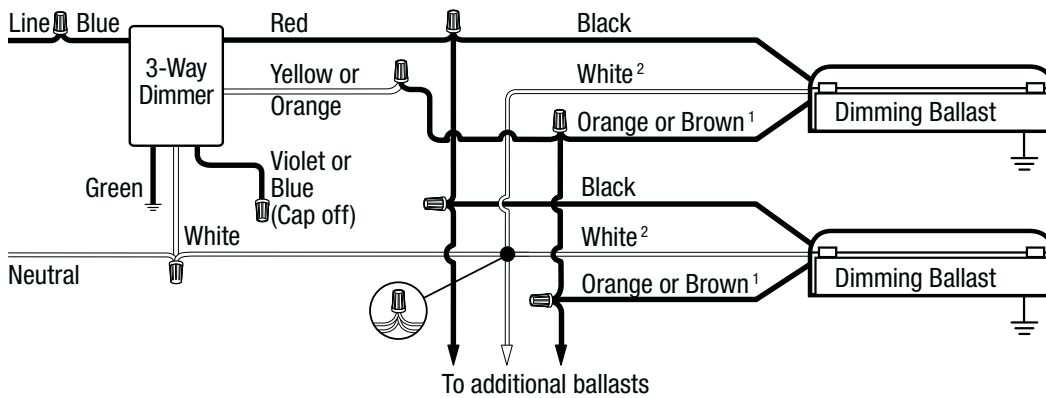

- Ground
 - Wire connector
 - Typical 4-wire connection
- NTF-103P-XX
NTF-103P-277-XX

¹Yellow/Blue or Yellow/Green when used with magnetic dimming ballasts
²Must use lamp disconnect sockets with magnetic dimming ballasts

3-Way Control Load Side

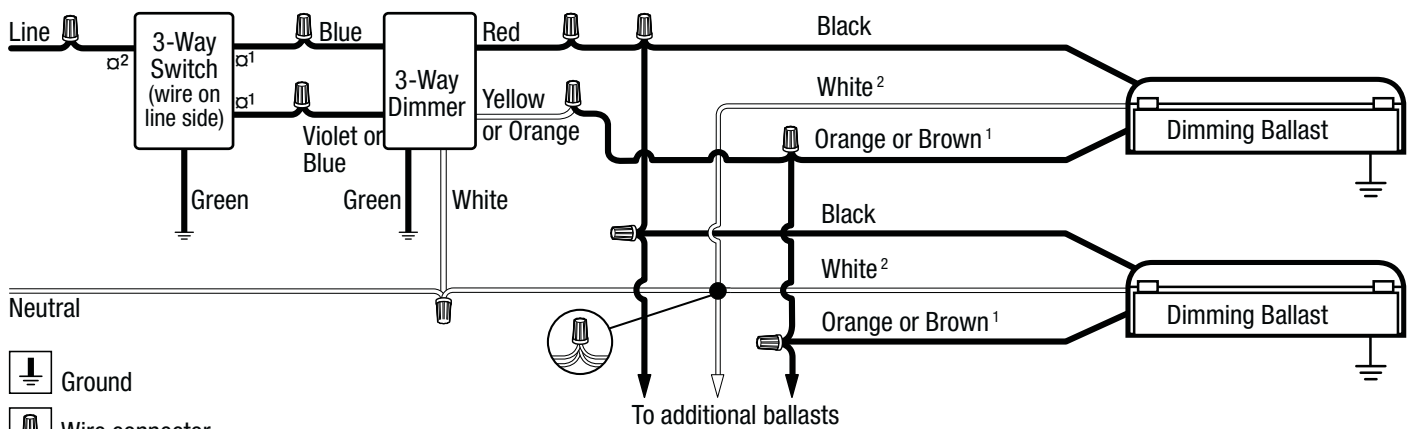

- Ground
 - Wire connector
 - Typical 4-wire connection
- NTF-103P-XX
NTF-103P-277-XX

¹Yellow/Blue or Yellow/Green when used with magnetic dimming ballasts
²Must use lamp disconnect sockets with magnetic dimming ballasts

⊠¹ Copper/Black screw terminal
⊠² Brass/Gold screw terminal

Note: Controls will have either screw terminals or wires.

Job Name:	Model Numbers:
Job Number:	

Wiring Diagrams: NTFTU- Controls

Single-Pole

NTFTU-5A-XX
NTFTU-5A-277-XX

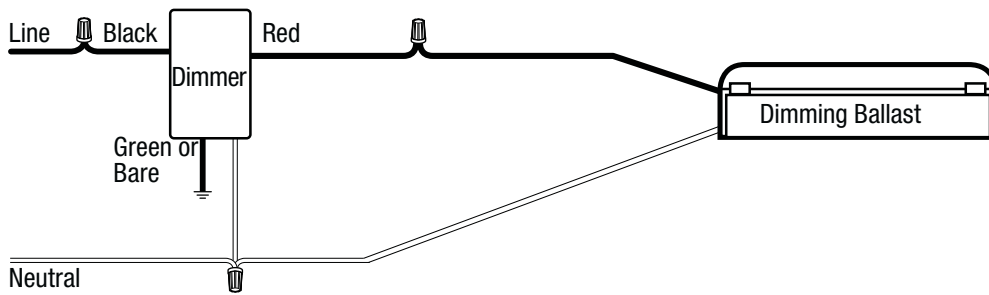

- Ground
- Wire connector

Single-Pole: 3-Way Control

NTFTU-3AP-277-XX-CPW0196

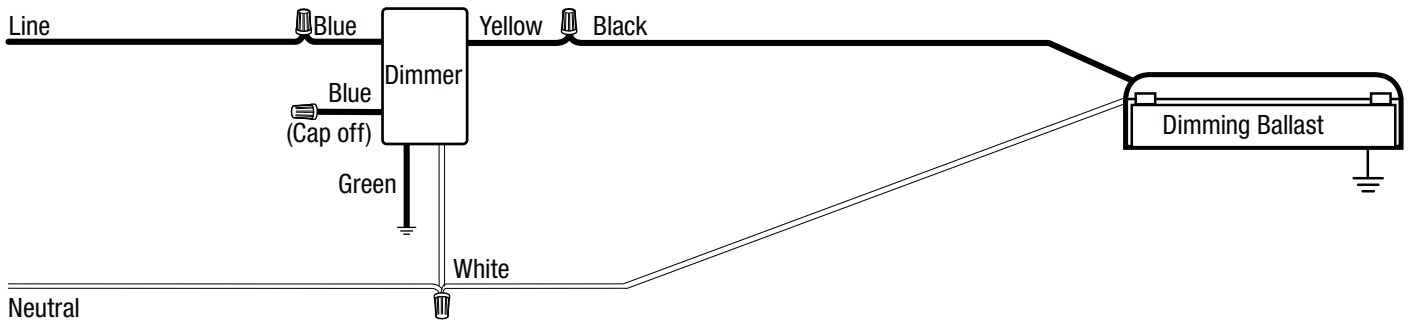

- Ground
- Wire connector

3-Way: Control Load Side

NTFTU-3AP-277-XX-CPW0196

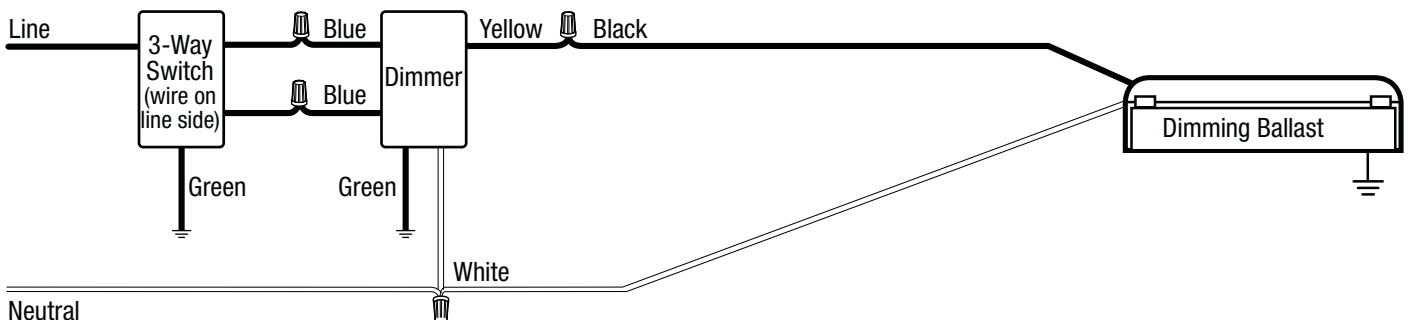

- Ground
- Wire connector

Job Name:	Model Numbers:
Job Number:	

Wiring Diagrams:

Note: The total 0–10 V_{DC} control signal wiring for this control should not exceed 500 ft (152.4 m). Do not use wire smaller than 20 AWG (0.75 mm²). For Class 1 installations, 0–10 V_{DC} wires must be run in conduit or approved cable per NEC® or local jurisdiction. For Class 2 installations, conduit is typically not required (local code may apply). For application with excessive electrical noise, 0–10 V_{DC} wires should be run in separate conduit from the mains.

NTSTV-DV-XX Control Class 1 Installation

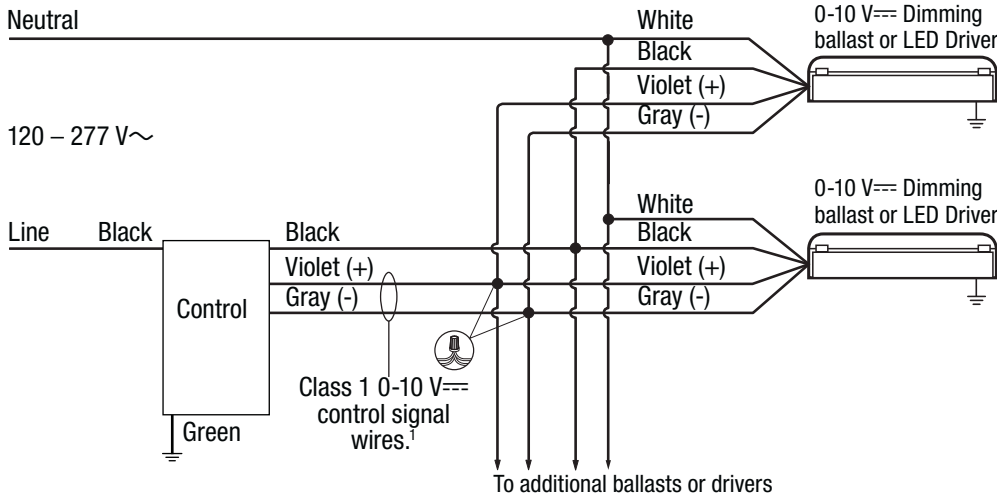

NTSTV-DV-XX

- Ground
- Wire connector

¹ Do NOT connect to line voltage.

Maximum Capacity:*

Load	0-10 V _{DC} Sink
8 A	30 mA

* Whichever comes first.

NTSTV-DV-XX Class 2 Installation

On/Off Control using Power Pack (PP-120H, PP-277H, or PP-347H)

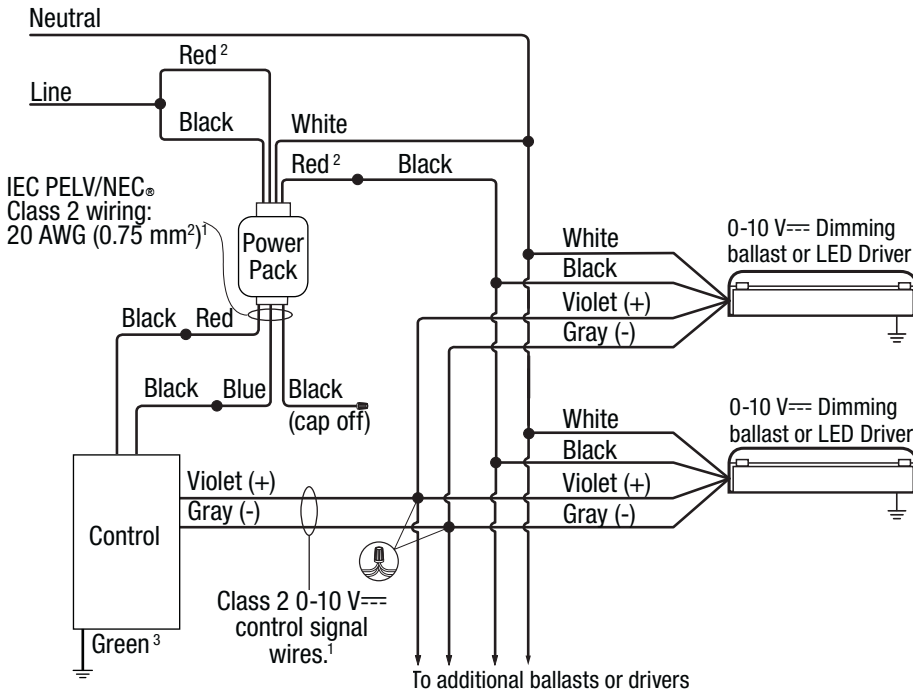

NTSTV-DV-XX

- Ground
- Wire connector

¹ Do NOT connect to line voltage

² 18 AWG (1.0 mm²) Red wires are interchangeable. Connect either to line/load side.

³ Green wire may be capped off for Class 2 installations ONLY.

Maximum Capacity for Class 2 Installations:

Load	0-10 V _{DC} Sink
5 A ⁴	30 mA

⁴ Multiple power packs can be used in parallel for higher loads.

Notice: Lutron is not liable for damage due to miswiring 0-10 V_{DC} control signal wires with line voltage. Do not run Class 2 wires and line voltage conductors together in the same conduit.

LUTRON® SPECIFICATION SUBMITTAL

<p>Job Name:</p> <p>Job Number:</p>	<p>Model Numbers:</p>
--	------------------------------