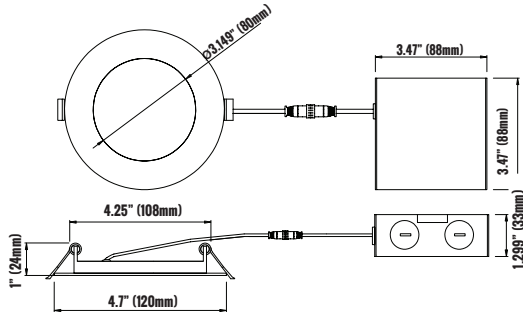

PRODUCT CODE: DLSR4-913D-WH-FF
4 INCH LED ULTRA SLIM PROFILE DOWNLIGHT

PRODUCT DESCRIPTION

Etlin-Daniels new generation of Ultraslim products features significantly higher efficacy along with superior Fire Code rated cabling. The new DLSR4-913D-WH-FF LED UltraSlim Profile Downlight is a modern and sleek looking energy efficient solution for both new construction and retrofit / remodeling projects. It installs in minutes where there is limited space due to ductwork, joists and beams. With our new lumen levels, we are now able to provide lighting options for higher ceiling heights than with previous generation products.

Why waste time installing older space restrictive recessed options when the new DLSR4 series provides a quick install solution and elegant, superior lighting for both residential and commercial applications.

FEATURES

- LED Indoor Light Source
- 4" LED downlight
- Durable air tight aluminum body
- Elegant white paint finish
- Etched white Polycarbonate diffuser lens
- Includes two spring loaded clips for mounting to any ceiling material
- Driver box using terminal connectors
- 50,000hrs L70 life
- Triac dimmable
- IC Air-tight rated
- FT6 Cable rating
- Damp location rated
- 5 year limited warranty
- Energy Star

PRODUCT SPECIFICATIONS (OPTICAL DATA)

LED TYPE	LED QTY	SYSTEM EFFICACY	LUMENS	COLOR TEMPERATURE	BEAM ANGLE	CRI	SYSTEM EFFICIENCY	VOLTAGE	POWER FREQ.	POWER EFFICIENCY	POWER FACTOR	HARMONIC DISTORTION
SMD 2835	44 CHIPS	83.3LM/W	750LM	3000K	120°	>80CRI	>0.96%	AC120V	50-60HZ	>80%	>0.96	<2%

PRODUCT SPECIFICATIONS (ELECTRICAL DATA)

PRODUCT SPECIFICATIONS

WATTAGE	FIXTURE MATERIAL	LIFE SPAN	STORAGE TEMP	OPERATING TEMP	PRODUCT DIMENSIONS	CARTON SIZE
9W	ALUMINUM/ POLYCARBONATE LENS	>50,000 HOURS	-40°C~+80°C -40°F~+176°F	-40°C~+60°C -4°F~+140°F	Ø4.7 X 1 INCHES (120 X 24 MM)	5.11 X 5.11 X 2.83 INCHES (130 X 130 X 72MM)

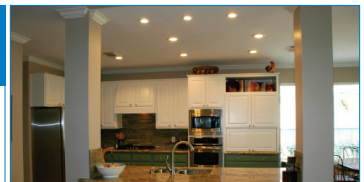

ADDITIONAL INFORMATION

INSTALLATION METHOD

RECESSED CEILING MOUNT

FIXTURE COLOR

WHITE WITH WHITE
ETCHED DIFFUSER

CONTROL TYPE

TRIAC DIMMABLE DRIVER INCLUDED

CATALOG #		TYPE
PROJECT		DATE
PREPARED BY		

PRODUCT CODE: DLSR4-913D-WH-FF 4 INCH LED ULTRA SLIM PROFILE DOWNLIGHT



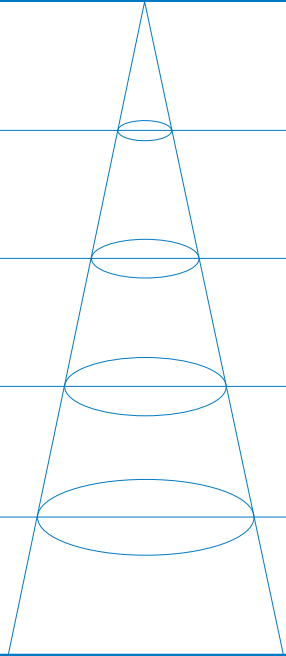

LUMINAIRE PHOTOMETRIC (TEST REPORT)

ILLUMINANCE (AT A DISTANCE) FLUX OUT: 750LM

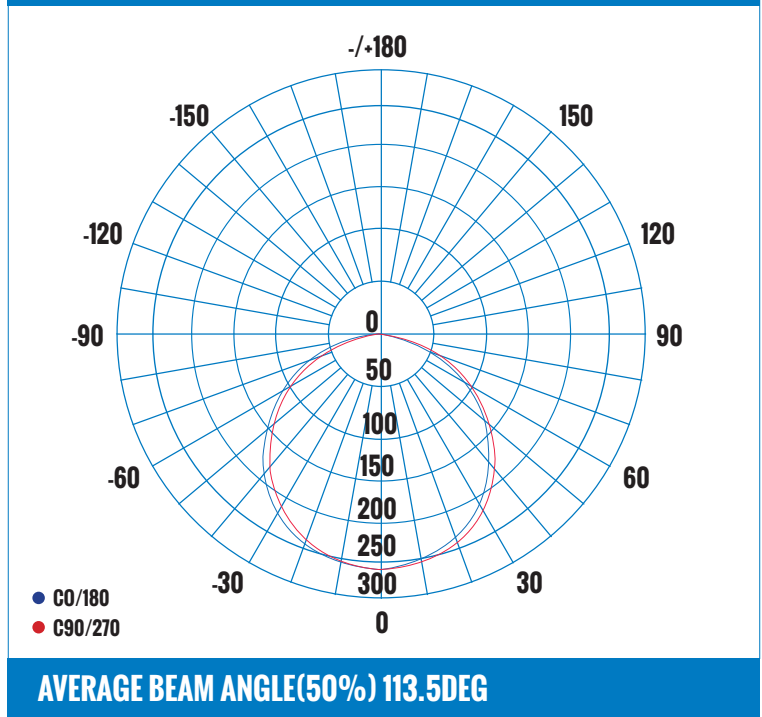
3.281FT 1M	6.630, 21.62FC 71.36, 232.7LX		9.20FT 280.40CM
6.562FT 2M	1.657, 5.406FC 17.84, 58.19LX		18.40FT 560.80CM
9.843FT 3M	0.7366, 2.402FC 7.929, 25.86LX		27.59FT 841.21CM
13.12FT 4M	0.4144, 1.351FC 4.460, 14.55LX		39.89FT 1216.0CM
16.4FT 5M	0.2652, 0.863FC 2.854, 9.310LX		46.00FT 1402.20CM
HT	EAVG/EMAX	ANGLE: 108.8DEG	DIA

LUMINOUS INTENSITY DISTRIBUTION DIAGRAM



CERTIFICATIONS 	DRIVER / LED CHIP 	120V APPROVED DIMMERS LUTRON: CTCL-153P · SCL-153P · DV-630P MAEL-153M · DVCL-153P · TGCL-153P LEVITON: 6672 · 6674 FEIT: 72309	ACCESSORIES  <p>72" EXTENSION CORD PART# DLSREC-72</p> <p>120" EXTENSION CORD PART# DLSREC-120</p>	PRE-MOUNTING PLATE FOR NEW CONSTRUCTION APPLICATIONS AVAILABLE. PLEASE CONTACT ETLIN-DANIELS.  PART NO#: DLS4-MP
---	---	---	--	---

ORDERING INFORMATION - DLSR SERIES

SERIES	SHAPE	SIZE	WATTAGE	VOLTAGE	COLOR TEMPERATURE	DIMMABLE	COLOR	LENS	TRIM
E.G. DLS	R	4	9	1	3	D	WH	F	F
DLS - DOWNLIGHT SLIM	R - ROUND	4 - 4"	9 - 9W	1 - 120V	3 - 3000K	D - TRIAC	WH - WHITE	F - FROSTED	F - FIXED

IF PRE-MOUNTING PLATE IS REQUIRED FOR NEW CONSTRUCTION PROJECTS, PLEASE QUOTE: PART NO#: DLS4-MP WHEN ORDERING.

Head Office - 1850 Wilson Ave. · Toronto, ON · M9M 1A1 · Tel: 416.741.7336 · Fax: 416.741.9104

Toll Free: in Canada. 1.800.661.9610 · in USA. 1.888.762.5384 (SOCKETS4U)

www.etlin-daniels.com · For sales/service questions - sales@etlin.com