

## Threaded Products and Hardware

### Channel Nuts

Superstrut® channel nuts are manufactured from Grade 2 mild steel and are case hardened.

### Design Data

Superstrut® self aligning channel nuts are designed to provide resistance to pullout and resistance to side slip in excess of the full strength of the channels with which they are used. The extreme resistance to side slip results from the unique design of the alternate teeth, spaced and designed to develop a wedging action that increases with pressure or load.

### Screw Threads

All threaded products are American Standard thread, free fit class 2.

| Thread Size             | 1/4 | 5/16 | 3/8 | 1/2 | 5/8 | 3/4 | 7/8 | 1   |
|-------------------------|-----|------|-----|-----|-----|-----|-----|-----|
| Threads per inch        | 20  | 18   | 16  | 13  | 11  | 10  | 9   | 8   |
| Design Torque (ft.-lb.) | 6   | 11   | 19  | 50  | 100 | 125 | 185 | 275 |

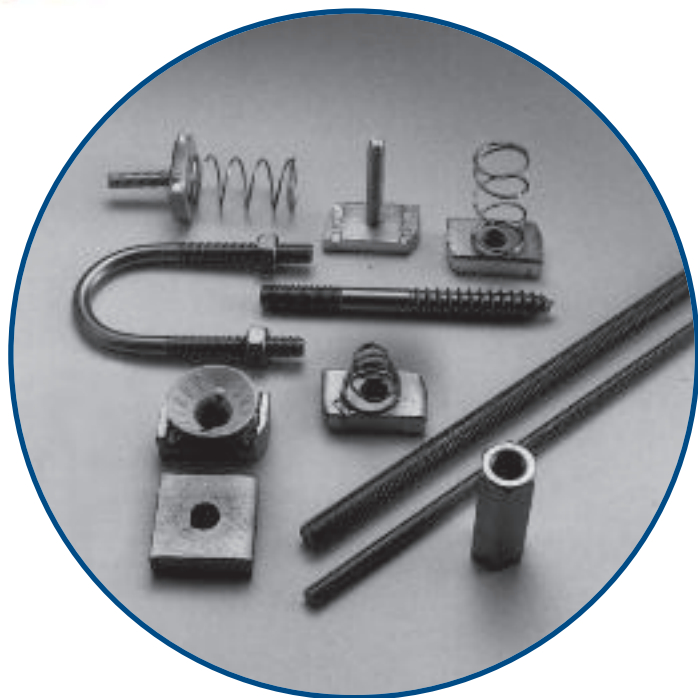

### Spring Nut Selector Chart

| SPRING NUT   | CHANNEL SERIES |        |   |   |   |   |
|--------------|----------------|--------|---|---|---|---|
|              | A - AR         | B - BR | C | D | E | H |
| A100-1/4EGC  | ■              |        | ■ |   |   |   |
| A100-5/16EGC | ■              |        | ■ |   |   |   |
| A100-3/8EGC  | ■              |        | ■ |   |   |   |
| A100-1/2EGC  | ■              |        | ■ |   |   |   |
| A100-3/4     | ■              |        | ■ |   |   |   |
| B100-1/4EGC  |                | ■      |   | ■ |   |   |
| B100-5/16EGC |                | ■      |   | ■ |   |   |
| B100-3/8EGC  |                | ■      |   | ■ |   |   |
| B100-1/2EGC  |                | ■      |   | ■ |   |   |
| H100-3/8EGC  |                |        |   |   | ■ | ■ |
| H100-1/2EGC  |                |        |   |   | ■ | ■ |
| CM100-1/4    | ■              | ■      | ■ | ■ | ■ | ■ |
| CM100-3/8    | ■              | ■      | ■ | ■ | ■ | ■ |
| CM100-1/2    | ■              | ■      | ■ | ■ | ■ | ■ |
| CM100-1/2B   |                | ■      |   |   |   |   |
| UC100-1/4    | ■              | ■      | ■ | ■ | ■ | ■ |
| UC100-3/8    | ■              | ■      | ■ | ■ | ■ | ■ |
| UC100-1/2    | ■              | ■      | ■ | ■ | ■ | ■ |

### Finish and special materials

Standard finish for all hardware is Electrogalvanized (EGC) or GoldGalv®. Stainless Steel Type 316 is also available. Contact your Regional Sales Office for availability and minimum quantities.

## Threaded Products and Hardware

### A100 Regular Spring Nut\*

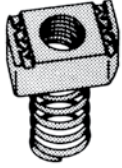

Available in Stainless Steel 316. Nut is square over 1/2 in. size. For all A and C Series channel and inserts.

| Cat. No.     | Size (in.) | Wt./C lb. |
|--------------|------------|-----------|
| A100-1/4EGC  | 1/4        | 8         |
| A100-5/16EGC | 5/16       | 9         |
| A100-3/8EGC  | 3/8        | 10        |
| A100-1/2EGC  | 1/2        | 12        |
| A100-5/8EGC  | 5/8        | 19        |
| A100-3/4     | 3/4        | 19        |
| A100-7/8     | 7/8        | 18        |



### B100 Short Spring Nut\*

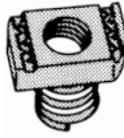

For all B and D Series channel and inserts.

| Cat. No.     | Size (in.) | Wt./C lb. |
|--------------|------------|-----------|
| B100-1/4EGC  | 1/4        | 7         |
| B100-5/16EGC | 5/16       | 8         |
| B100-3/8EGC  | 3/8        | 9         |
| B100-1/2EGC  | 1/2        | 9         |



### H100 Long Spring Nut\*

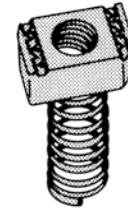

For all E and H Series channel and inserts.

| Cat. No.    | Size (in.) | Wt./C lb. |
|-------------|------------|-----------|
| H100-3/8EGC | 3/8        | 10        |
| H100-1/2EGC | 1/2        | 14        |



### AB100 Springless Nut 1/4 in. thick

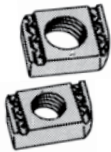

For use with all channels. Nut is square over 1/2 in. size.

| Cat. No.      | Size (in.) | Wt./C lb. |
|---------------|------------|-----------|
| AB100-1/4EGC  | 1/4        | 7         |
| AB100-5/16EGC | 5/16       | 8         |
| AB100-3/8EGC  | 3/8        | 9         |
| AB100-1/2EGC  | 1/2        | 9         |
| AB100-5/8EGC  | 5/8        | 10        |
| AB100-3/4EGC  | 3/4        | 10        |



### AC100 Springless Nut Heavy duty 3/8 in. thick



For all A, C, E and H Series channel and inserts. Nut is square over 1/2 in. size.

| Cat. No.     | Size (in.) | Wt./C lb. |
|--------------|------------|-----------|
| AC100-3/8EGC | 3/8        | 9         |
| AC100-1/2EGC | 1/2        | 11        |
| AC100-5/8EGC | 5/8        | 18        |
| AC100-3/4EGC | 3/4        | 18        |



### 813EG Springless Nut Light Duty

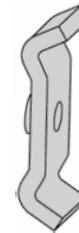

For use with all channels.

| Cat. No. | Size (in.) | Wt./C lb. |
|----------|------------|-----------|
| 813EG    | 1/4        | 5         |



### A182 to A185 Regular Spring Stud Nut\*



For all A and C Series channels.

| Cat. No.       | Bolt Dia (in.) | Length A (in.) | Wt./C lb. |
|----------------|----------------|----------------|-----------|
| A182-1/4x100EG | 1/4            | 1              | 10        |
| A182-1/4x125EG | 1/4            | 1-1/4          | 15        |
| A184-3/8x100EG | 3/8            | 1              | 10        |
| A184-3/8x125EG | 3/8            | 1-1/4          | 15        |
| A185-1/2x100EG | 1/2            | 1              | 10        |
| A185-1/2x125EG | 1/2            | 1-1/4          | 15        |



### A177 to A179 Springless Stud Nut

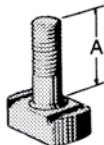

For use with all channels.

| Cat. No.       | Bolt Dia (in.) | Length A (in.) | Wt./C lb. |
|----------------|----------------|----------------|-----------|
| A177-1/4x100EG | 1/4            | 1              | 8         |
| A177-1/4x125EG | 1/4            | 1-1/4          | 10        |
| A179-3/8x100EG | 3/8            | 1              | 13        |
| A179-3/8x125EG | 3/8            | 1-1/4          | 13.5      |



### 812 Stud Nut

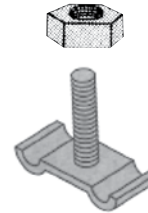

For attaching fixture to channel slot down or to channel slot up knockouts. Specify length. Hex nut included.

| Cat. No. | For Channel | Wt./C lb. |
|----------|-------------|-----------|
| 812-1EG  | 1/4 x 1     | 6         |



### CM100 Nylon Cone Nut

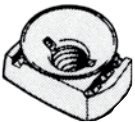

GoldGalv® only  
For all 1-5/8 in. channel.  
\*\*Will not fit B Series channel.  
\*\*\*For B Series channel.

| Cat. No.      | Size (in.) | Wt./C lb. |
|---------------|------------|-----------|
| CM100-1/4     | 1/4        | 8         |
| CM100-3/8     | 3/8        | 10        |
| *CM100-1/2    | 1/2        | 12        |
| ** CM100B-1/2 | 1/2        | 10        |



### UC100 Universal Nylon Cone Nut

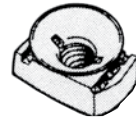

GoldGalv® only  
For all 1-5/8 in. and 1-1/2 in. channels.  
May be used with ALL Strut Depths.  
Can be used for CM100 Series, A100 Series, B100 Series and AB100 Series.

| Cat. No.  | Size (in.) | Wt./C lb. |
|-----------|------------|-----------|
| UC100-1/4 | 1/4        | 8         |
| UC100-3/8 | 3/8        | 10        |
| UC100-1/2 | 1/2        | 12        |



### AB102 Unhardened Square Nut

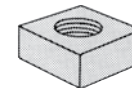

| Cat. No.  | Size (in.) | Wt./C lb. |
|-----------|------------|-----------|
| AB102-1/4 | 1/4        | 13        |
| AB102-3/8 | 3/8        | 14        |
| AB102-1/2 | 1/2        | 14        |
| AB102-5/8 | 5/8        | 12        |
| AB102-3/4 | 3/4        | 11        |
| AB102-7/8 | 7/8        | 10        |



### E145 Standard Hex Nut



| Cat. No.    | Size (in.) | Wt./C lb. |
|-------------|------------|-----------|
| E145-1/4EGC | 1/4        | .72       |
| E145-3/8EGC | 3/8        | 1.60      |
| E145-1/2EGC | 1/2        | 2.78      |
| E145-5/8EGC | 5/8        | 6.92      |
| E145-3/4EGC | 3/4        | 12.70     |
| E145-7/8EGC | 7/8        | 19.00     |
| E145-1EGC   | 1          | 28.00     |



### ES145 Swivel Nut and Jam Nut Combinations

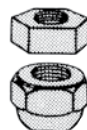

| Cat. No.  | Size (in.) | Wt./C lb. |
|-----------|------------|-----------|
| ES145-3/8 | 3/8        | 5.5       |
| ES145-1/2 | 1/2        | 6.0       |



### E146 Standard Square Nut



| Cat. No.     | Size (in.) | Wt./C lb. |
|--------------|------------|-----------|
| E146-1/4EGC  | 1/4        | .93       |
| E146-5/16EGC | 5/16       | 1.60      |
| E146-3/8EGC  | 3/8        | 2.65      |
| E146-1/2EGC  | 1/2        | 5.83      |
| E146-5/8EGC  | 5/8        | 10.80     |



\*Supplied with a plastic sleeve over the spring portion to prevent tangling inside the carton.

## Threaded Products and Hardware

### E147 Flat Steel Washer

STD. PACK: 100

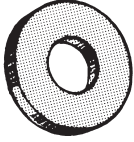

| Cat. No.    | Size (in.) | Wt./C lb. |
|-------------|------------|-----------|
| E147-1/4EG  | 1/4        | 0.67      |
| E147-5/16EG | 5/16       | 1.11      |
| E147-3/8EG  | 3/8        | 1.49      |
| E147-1/2EG  | 1/2        | 3.85      |
| E147-5/8EG  | 5/8        | 7.69      |
| E147-3/4EG  | 3/4        | 9.89      |
| E147-7/8EG  | 7/8        | 15.40     |

Available in Stainless Steel.

### EF147 Fender Washer

STD. PACK: 100

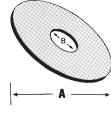

| Cat. No.     | Size (in.) | A (in.) | B (in.) | Wt./C lb. |
|--------------|------------|---------|---------|-----------|
| EF147-1/4EGC | 1/4        | 1-1/4   | 5/16    | 3.1       |
| EF147-3/8EGC | 3/8        | 1-1/2   | 7/16    | 2.9       |
| EF147-1/2EGC | 1/2        | 2       | 9/16    | 5.0       |

Available in Stainless Steel.

### E148 Lock Washer

STD. PACK: 100



| Cat. No.   | Size (in.) | Wt./C lb. |
|------------|------------|-----------|
| E148-1/4EG | 1/4        | 0.26      |
| E148-3/8EG | 3/8        | 0.50      |
| E148-1/2EG | 1/2        | 1.09      |
| E148-5/8EG | 5/8        | 2.57      |

Available in Stainless Steel.

### E142 Hex Head Cap Screw

STD. PACK: 100

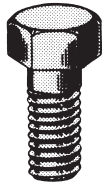

| Cat. No.       | Size (in.) | Wt./C lb. |
|----------------|------------|-----------|
| E142-1/4x100EG | 1/4x1      | 1.74      |
| E142-1/4x150EG | 1/4x1-1/2  | 2.43      |
| E142-3/8x100EG | 3/8x1      | 4.17      |
| E142-3/8x150EG | 3/8x1-1/2  | 5.64      |
| E142-1/2x100EG | 1/2x1      | 8.94      |
| E142-1/2x150EG | 1/2x1-1/2  | 10.00     |
| E142-1/2x200EG | 1/2x2      | 11.19     |
| E142-1/2x225EG | 1/2x2-1/4  | 11.90     |
| E142-1/2x250EG | 1/2x2-1/2  | 12.52     |
| E142-1/2x275EG | 1/2x2-3/4  | 13.22     |

Available in Stainless Steel.

### E150S Lag Bolt

STD. PACK: 50



| Cat. No.          | Drill Size (in.) | Size (in.) | Wt./C lb. |
|-------------------|------------------|------------|-----------|
| E150S-3/8x1-1/2EG | 1/4              | 3/8x1-1/2  | 5         |
| E150S-3/8x2EG     | 1/4              | 3/8x2      | 7         |
| E150S-3/8x2-1/2EG | 1/4              | 3/8x2-1/2  | 8         |
| E150S-3/8x3EG     | 1/4              | 3/8x3      | 9         |
| E150S-1/2x1-1/2EG | 11/32            | 1/2x1-1/2  | 12        |
| E150S-1/2x2EG     | 11/32            | 1/2x2      | 13        |
| E150S-1/2x2-1/2EG | 11/32            | 1/2x2-1/2  | 15        |
| E150S-1/2x3EG     | 11/32            | 1/2x3      | 18        |

### E151 Coach Screw Rod



| Cat. No.      | Rod Size (in.) | Std Rod Lengths (in.) | Wt./C lb. |
|---------------|----------------|-----------------------|-----------|
| E151-3/8x4EG  | 3/8            | 4                     | 9         |
| E151-3/8x6EG  | 3/8            | 6                     | 14        |
| E151-3/8x8EG  | 3/8            | 8                     | 22        |
| E151-3/8x10EG | 3/8            | 10                    | 29        |
| E151-3/8x12EG | 3/8            | 12                    | 35        |
| E151-1/2x4EG  | 1/2            | 4                     | 17        |
| E151-1/2x6EG  | 1/2            | 6                     | 22        |
| E151-1/2x8EG  | 1/2            | 8                     | 40        |
| E151-1/2x10EG | 1/2            | 10                    | 51        |

Machine threaded opposite end, carbon steel.

### H104 Hanger Rod Continuous Threaded



STD. PACK: 3

| Cat. No.       | Thread Size (in.) | Wt./lb. 100 ft. | Design Load lb. |
|----------------|-------------------|-----------------|-----------------|
| H104-1/4x10EGC | 1/4               | 12.5            | 150             |
| H104-3/8x10EGC | 3/8               | 29              | 610             |
| H104-1/2x10EGC | 1/2               | 53.5            | 1130            |
| H104-5/8x10EGC | 5/8               | 85              | 1810            |
| H104-3/4x10EGC | 3/4               | 123             | 2710            |
| H104-7/8x10EG  | 7/8               | 130             | 3770            |
| H104-1x10EG    | 1                 | 214             | 4960            |

- Black available upon request
- Sold per foot; standard length, 10 ft.
- Also available in stainless steel (316) standard length 6 ft.
- National coarse thread

### H119 Rod Couplings

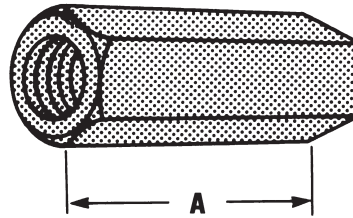

| Rod Size | A (in.) | Wt./C lb. |
|----------|---------|-----------|
| 1/4      | 7/8     | 1.90      |
| 5/16     | 7/8     | 3.75      |
| 3/8      | 1-1/8   | 3.50      |
| 1/2      | 1-1/4   | 5.50      |
| 5/8      | 2-1/8   | 18.00     |
| 3/4      | 2-1/4   | 28.00     |
| 7/8      | 2-1/2   | 55.00     |
| 1        | 2-1/4   | 56.00     |

Standard Rod Coupling  
**Example:** H119-1/2EG

Order by product number, rod size, and finish.  
 Available in Stainless Steel.

| Rod Size   | A (in.) | Wt./C lb. |
|------------|---------|-----------|
| 1/4 to 3/8 | 1-1/2   | 3.50      |
| 3/8 to 1/2 | 1-1/4   | 6.70      |
| 1/2 to 5/8 | 1-1/4   | 14.00     |
| 5/8 to 3/4 | 1-1/2   | 21.00     |
| 3/4 to 7/8 | 1-3/4   | 40.00     |

Rod Reducer Coupling  
**Example:** H119-1/4x3/8EG

## Threaded Products and Hardware

### H122 Trapnut™ Strut Fastener

| Cat. No.      | Size (in.) | Design Load lb. | Std. Ctn. |
|---------------|------------|-----------------|-----------|
| H 122 1/4     | 1/4        | 150             | 50        |
| H 122 3/8     | 3/8        | 590             |           |
| H 122 1/2     | 1/2        | 1080            |           |
| H 122 1/4 EG  | 1/4        | 150             |           |
| H 122 3/8 EG  | 3/8        | 590             |           |
| H 122 1/2 EG  | 1/2        | 1080            |           |
| H 122 1/4 SS6 | 1/4        | 150             |           |

**Finishes:** Electrogalvanized (EG), GoldGalv®, Stainless Steel Type 316 (SS6)



### M117 Eye Socket

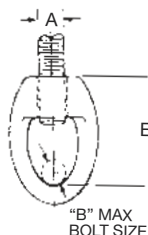

| Rod Size A (in.) | Pipe Size (in.) | B (in.) | E (in.) | Wt./C lb. | Design Load, lb. |
|------------------|-----------------|---------|---------|-----------|------------------|
| 1/4              | 3/8             | 1/4     | 1-11/32 | 5         | 230              |
| 3/8              | 1/2 - 2         | 1/4     | 1-11/32 | 7         | 610              |
| 1/2              | 2-1/2 - 3-1/2   | 1/4     | 1-17/32 | 13        | 1130             |
| 5/8              | 4 - 5           | 3/8     | 1-13/16 | 19        | 1810             |
| 3/4              | 6               | 1/2     | 2-5/32  | 31        | 2400             |
| 7/8              | 8               | 1/2     | 2-11/32 | 44        | 2800             |

#### Standard Finishes - Bare (B), Electrogalvanized (EG)

Malleable iron. For attaching hanger rod to various types of hangers and beam clamps.

Order by product number, rod size, and finish. **Example: M117-1/4B**

Complies with Specification MSS SP69, Type 16.

### E120 Swivel Joint

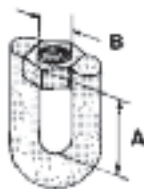

| Cat. No. | Size (in.) | A (in.) | B (in.) | Wt./C lb. | Design Load, lb. |
|----------|------------|---------|---------|-----------|------------------|
| E120-3/8 | 3/8        | 1-3/8   | 3/8     | 15        | 1000             |
| E120-1/2 | 1/2        | 1-1/2   | 1/2     | 25        | 1800             |

### E120A Weldless Eye Nut

#### Standard Finish - Bare (B)

Drop Forged Steel.

For use on high temperature piping installations.

Order by product number and rod size.

**Example: E120A-3/8B**

| Rod Size T | A (in.) | B (in.) | C (in.) | D (in.) | E (in.) | F (in.) | Wt./C lb. | Design Load, lb. |
|------------|---------|---------|---------|---------|---------|---------|-----------|------------------|
| 3/8        | 7/8     | 5/8     | 1-1/4   | 2       | 2-1/2   | 3/8     | 20        | 2700             |
| 1/2        | 7/8     | 5/8     | 1-1/4   | 2       | 2-1/2   | 3/8     | 22        | 2700             |
| 5/8        | 1-3/8   | 3/4     | 1-1/2   | 2-1/2   | 3       | 1/2     | 60        | 5000             |
| 3/4        | 1-3/8   | 3/4     | 1-1/2   | 2-1/2   | 3       | 1/2     | 56        | 5000             |
| 7/8        | 1-1/2   | 1-5/8   | 1-5/16  | 3-5/8   | 4-1/2   | 3/4     | 174       | 10000            |
| 1          | 1-1/2   | 1-5/8   | 1-5/16  | 3-5/8   | 4-1/2   | 3/4     | 168       | 10000            |

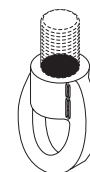

### E122 Swivel Joint

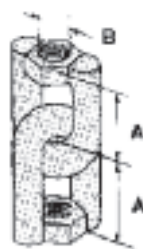

| Cat. No. | Size (in.) | A (in.) | B (in.) | Wt./C lb. | Design Load, lb. |
|----------|------------|---------|---------|-----------|------------------|
| E122-3/8 | 3/8        | 1-3/8   | 3/8     | 28        | 1000             |
| E122-1/2 | 1/2        | 1-1/2   | 1/2     | 48        | 1800             |

### E130 Swivel Joint

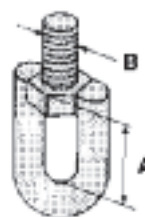

| Cat. No. | Size (in.) | A (in.) | B (in.) | Wt./C lb. | Design Load, lb. |
|----------|------------|---------|---------|-----------|------------------|
| E130-3/8 | 3/8        | 1-3/8   | 3/8     | 23        | 1000             |
| E130-1/2 | 1/2        | 1-1/2   | 1/2     | 28        | 1800             |

### E131 Swivel Joint

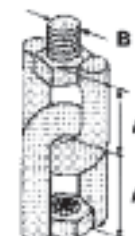

| Cat. No. | Size (in.) | A (in.) | B (in.) | Wt./C lb. | Design Load, lb. |
|----------|------------|---------|---------|-----------|------------------|
| E131-3/8 | 3/8        | 1-3/8   | 3/8     | 25        | 1000             |
| E131-1/2 | 1/2        | 1-1/2   | 1/2     | 52        | 1800             |

## Threaded Products and Hardware

### C781 Square Washer

STD.  
PACK:  
50

| Cat. No.  | Rod Size (in.) | Hole Size (in.) | Overall Dimensions (in.) | Wt./C lb. |
|-----------|----------------|-----------------|--------------------------|-----------|
| C781-3/8* | 3/8            | 7/16            | 3 x 3 x 3/16             | 27        |
| C781-1/2* | 1/2            | 9/16            | 3 x 3 x 3/16             | 27        |
| C781-5/8* | 5/8            | 11/16           | 3 x 3 x 1/4              | 47        |
| C781-3/4* | 3/4            | 13/16           | 3 x 3 x 1/4              | 42        |
| C781-7/8* | 7/8            | 15/16           | 4 x 4 x 3/8              | 85        |
| C781-1*   | 1              | 1-1/8           | 4 x 4 x 3/8              | 160       |

#### \*Finishes

- B
- HDG
- EG
- SS6

Used for beam applications.  
For channel applications use AB241.

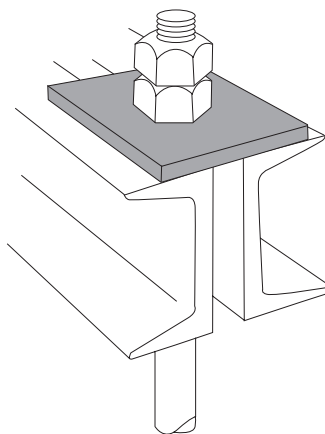

### H115 Standard U-Bolt

| Pipe Size (in.) | A (in.) | B (in.) | C (in.) | D (in.) | E (in.)  | Wt./C lb. | Design Load, lb. |
|-----------------|---------|---------|---------|---------|----------|-----------|------------------|
| 1/2             | 15/16   | 1-3/4   | 1-1/2   | 1/4     | 2-3/4    | 13        | 1500             |
| 3/4             | 1-1/8   | 1-3/4   | 1-5/8   | 1/4     | 3-1/16   | 15        | 2000             |
| 1               | 1-3/8   | 1-7/8   | 1-5/8   | 1/4     | 3-5/16   | 16        | 2500             |
| 1-1/4           | 1-23/32 | 1-3/4   | 1-15/32 | 3/8     | 3-1/2    | 17        | 2500             |
| 1-1/2           | 2       | 1-3/4   | 1-7/16  | 3/8     | 3-3/4    | 18        | 2500             |
| 2               | 2-7/16  | 2-1/16  | 1-7/8   | 3/8     | 4-11/16  | 32        | 3300             |
| 2-1/2           | 2-15/16 | 2-1/16  | 1-13/16 | 1/2     | 5-1/8    | 34        | 4000             |
| 3               | 3-9/16  | 2       | 1-3/4   | 1/2     | 5-11/16  | 38        | 4000             |
| 3-1/2           | 4-3/32  | 2       | 1-23/32 | 1/2     | 6-3/16   | 40        | 4000             |
| 4               | 4-19/32 | 2-1/4   | 1-31/32 | 1/2     | 6-15/16  | 46        | 4000             |
| 5               | 5-5/8   | 3       | 2-7/32  | 1/2     | 8-5/16   | 101       | 4000             |
| 6               | 6-3/4   | 3-3/4   | 2-13/16 | 5/8     | 10-1/8   | 197       | 4000             |
| 8               | 8-3/4   | 3-3/4   | 2-13/16 | 5/8     | 12-1/8   | 233       | 4000             |
| 10              | 10-7/8  | 4       | 3       | 3/4     | 14-9/16  | 491       | 5400             |
| 12              | 12-7/8  | 4-1/4   | 3-1/4   | 7/8     | 16-15/16 | 773       | 7500             |

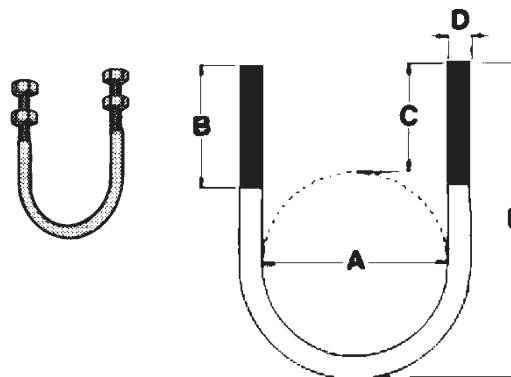

Standard Finishes - Electrogalvanized (EG), GoldGalv®, Stainless Steel or Bare (B)

Example: H115-1/2EG

Sizes through 4 in. furnished with one hex nut per leg.

Sizes 5 in. and above furnished with two hex nuts per leg.

Order by Cat. No., pipe size, finish.

Complies with Specification MSS SP69, Type 24.