

Fuse Systems

BETA Low-Voltage Circuit Protection
Technology Primer



Answers for industry.

SIEMENS

Preface

Whether for protection, switching, monitoring, or measuring purposes, BETA low-voltage circuit protection offers a wide range of solutions covering every application in electrical installation technology. BETA devices are ideal for use in residential buildings, non-residential buildings, as well as in industrial applications, thereby enabling you to successfully manage all your electrical circuits.

This is particularly important when it comes to choosing and installing the right fuses.

This primer aims to help you optimize fuse links, fuse holders, and switching devices in line with the requirements of electrical systems. In addition to general information about fuse systems, this document contains important installation and application guidelines, thereby ensuring that you always choose the right device for the right application.

The BETA Low-Voltage Circuit Protection Team

Contents

Introduction	6
1 Totally Integrated Power	7
2 The History of Siemens Fuse Systems – From Safety Inserts to High-Performance Fuses	8
3 Siemens Fuse Systems	12
3.1 NEOZED and DIAZED Screw-In Fuse Link Systems	13
3.2 LV HRC Fuse System	18
3.3 Busbar Systems	24
3.4 Cylindrical Fuse System and Class CC Fuse System	28
3.5 SITOR Semiconductor Fuses	31
3.6 MINIZED and SENTRON Load Interrupter Switches with Fuse	33
3.7 Communication-Capable Fuses	43
3.8 Quality and Environmental Protection	46
4 Function, Technical Specifications, and Characteristic Curves	49
4.1 Current Interruption and Limitation	49
4.2 Labeling of Fuses	52
4.3 Characteristic Curves	54
4.4 Selectivity	56
4.5 Power Dissipation (Power Loss)	60
5 Fuse Applications	64
5.1 General Selection Criteria	64
5.2 Cable and Line Protection	65
5.3 Transformer Protection with LV HRC Fuses	66
5.4 Protecting Electrical Motor Circuits	67
5.5 Semiconductor Protection	68
5.6 Protecting DC Circuits	70
5.7 Battery Protection in UPS	72
5.8 Capacitor Protection in Reactive-Power Compensation Equipment	73
5.9 Special Applications and Environmental Conditions	76
5.10 Protecting Photovoltaic Systems	80
6 SIMARIS Design	80
7 National and International Fuse Standards	81
8 Appendix	84
List of Diagrams and Tables	86

Introduction

An electrical plant is only as good as its protective devices!

Overcurrents in electrical plants can occur as a result of excessive load or short-circuit faults. They can cause thermal damage to equipment and have catastrophic aftereffects, such as fire and electric arc faults. As well as endangering personnel, overcurrents can lead to severe economic losses due to the resulting downtime and the costs incurred for restoring operational equipment.

This is why effective overcurrent protection devices have been indispensable, and indeed mandatory, ever since electricity was first harnessed to power equipment. Although they cannot completely exclude the risk of faults, they can help minimize any potential damage. For over 100 years now, Siemens has manufactured high-quality fuse systems that provide reliable protection for expensive electrical plants and offer an efficient, cost-effective means of minimizing risk. The price ultimately paid for using low-quality protective devices can be a very high one.

Electrical fuses offer maximum protection against the effects of overcurrents in plants and networks. They are characterized by:

- Current-limiting short-circuit interruption
- High switching capacity with a compact design
- High level of reliability and efficiency
- Straightforward assignment to equipment and selective grading
- High level of compatibility with other protective devices

Fuses can only offer the required level of reliability, however, when they are carefully developed, manufactured, and deployed in the right application.

For more than a century now, operators of Siemens fuse systems have been able to rely on outstanding development expertise and unerring commitment to manufacturing quality products. This level of experience is indispensable because the physical processes involved when melting fuses are switched still cannot be adequately modeled mathematically. For this reason, only laboratory experiments and hands-on experience can yield a degree of certainty about the actual switching behavior. Thanks ultimately to the experience and sense of responsibility of all Siemens employees, customers can have the utmost confidence in products whose proper functioning dictates their lifetime, a fact that cannot be ascertained prior to shipment.

To assign fuse systems to the right protective task, operators require a basic understanding of the functional principles as well as a minimum understanding of the information printed on the fuse and the technical specifications provided by the manufacturer. This guide to Siemens fuses aims to deliver that basic knowledge¹⁾. Although this document cannot provide you with all the answers to your questions about fuses, it will help you identify problematic applications in good time so that you are in a position to obtain exactly the information you require from the Siemens Customer Service Center.

¹⁾ *Safety note: Any technical specifications or characteristic curves contained in this document are for illustrative purposes only and are not binding. Please refer to the current Siemens product data sheets for the relevant configuration data.*

1 Totally Integrated Power

Siemens Totally Integrated Power™² is an end-to-end system featuring products that are carefully matched and cover all phases of electrical power distribution, from medium-voltage applications to power sockets (Fig. 1.1).



Fig. 1.1 – Electrical power distribution within buildings

Totally Integrated Power provides solutions covering all phases of electrical power distribution, from investment decisions and planning to installation and operation. In every phase of power distribution projects, this concept offers key benefits for all those involved:

- Building investors
- Electrical planners
- Installation engineers
- Operators



Fig. 1.2 – Customer benefits offered by Totally Integrated Power



Totally Integrated Power offers end-to-end solutions for electrical power distribution in functional and industrial buildings. Totally Integrated Power is linked to the project cycle (Fig. 1.2) and helps leverage savings potential.

Whether in hotels, administrative and office buildings, shopping malls, airports, hospitals, or production facilities, Siemens has developed a concept for all functional and industrial buildings that offers considerable benefits during planning, installation, and operation.

Switching and protection are key functions designed to ensure that electrical plants can be operated efficiently and safely. A wide range of fused and non-fused components are available to protect against the effects of overcurrents:

- Circuit breakers
- Miniature circuit breakers
- LV HRC fuse switch disconnectors
- LV HRC switch disconnectors with fuses

² Totally Integrated Power™ is a registered trademark of Siemens AG

A wide range of fuse material is also available (Fig. 1.3 BETA Low-Voltage Circuit Protection)

This end-to-end Siemens protection concept facilitates planning, increases operational reliability thanks to harmonized products and systems, optimizes installation and commissioning tasks, and minimizes downtime thanks to reliable, selective short-circuit interruption.

Siemens low-voltage fuse systems are permanent, key components of this end-to-end system of technically-compatible products.



Fig. 1.3 – Fuses are key components of BETA low-voltage circuit protection

2 The History of Siemens Fuse Systems

– From Safety Inserts to High-Performance Fuses

The use of electrical energy to generate light and power began with the development of self-excited dynamos by Werner Siemens in 1866. As a result, the output of generators and motors was no longer restricted by the magnetic field strength of permanent magnets and could be increased almost indefinitely. The fastest-growing field of application was for electric lighting with light bulbs, the popularity of which grew dramatically from 1880 onwards.

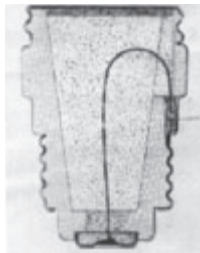

Fig. 2.1 – Fuse insert with Edison thread (around 1900)

Without the protection offered by fuses, the widespread use of electric lighting in public and private buildings would have been unthinkable as it was simply too dangerous. Although thin platinum filaments had already been used to fuse telegraph cables, the development of high-voltage current fuses did not begin until the introduction of powerful electrical lighting installations. Right from the very beginning, Siemens has played a leading role in the development of melting fuse systems.

The first power installations, however, were easily combustible. The following report was carried in a journal of electrical engineering in September 1882. It concerns the lighting systems in-stalled in Hull (England) by Siemens Brothers & Co., London, in the old town and in the town hall:

Source: "Elektrotechnische Nachrichten" (May 1909)

"To increase safety and exclude any risk of fire in the town hall, all filaments are covered with rubber and canvas, while each individual bulb is fitted with a safety insert that, should the temperature in the circuit exceed reasonable levels, is caused to melt, thereby inter-rupting the circuit."³⁾

These "safety inserts" can be considered forerunners of the fuse insert with an Edison thread (see Fig. 2.1), which dominated the market for protective elements in electrical circuits until well into the first decade of the 20th century and were vastly superior to lead-strip fuses, which were also very popular.

In accordance with the safety guidelines issued in 1896 by the VDE (German Electrical Engineering Association), the "Edison insert" was equipped with finely-tuned silver fuse elements that could be used with any cable crosssection and were non-interchangeable across installation lengths and in accordance with currents.

The increasing power of electrical plants, however, soon began to test the limits of "Edison inserts" and it quickly became apparent that the breaking capacity could no longer handle these new requirements, a fact demonstrated by a large-scale series of tests performed in electricity plants throughout Germany in 1904 "Many inserts malfunctioned with a loud bang, sending out flames which, due to the lack of emergency fuses up-stream, would have resulted in serious fires. Even the best plugs at our disposal were no longer entirely fault free."⁴⁾

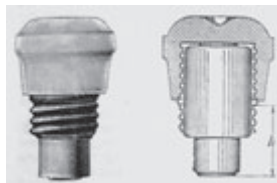

Fig. 2.2 – Two-piece screw-in fuse-link from Siemens-Schuckertwerke (around 1904)

Source: "Elektrotechnische Zeitschrift" (February 1909)

The time had come for DIAZED^{® 5)}, a more modern, high-performance generation of fuses.

In response to the poor results of this official series of tests, Siemens-Schuckertwerke show-cased a new design (Fig. 2.2) that "quite rightly caused a sensation with its short-circuit strength even at 550 V"⁶⁾. No wonder, because "the (Siemens) cartridges did not make a sound and did not fail once. The two-piece insert (porcelain cylinder cartridge with screw-type head) was immediately recognized as the most practical form of Edison insert".

To achieve this superior switching behavior, the Siemens design featured a thick-walled porcelain body with a narrow switching space and talcum filling as well as greater distances between the electrodes. The two-piece design meant that the screw-type head could be handled more easily and the cartridges replaced more cheaply. Encouraged by the excellent test results of this Siemens design, a sub-committee set about defining the requirements for a "standardized fuse" as requested by the Vereinigung der Elektrizitätswerke (association of electricity supply companies):

- Short-circuit strength
- 500 V rated voltage
- Non-interchangeability
- Indicator

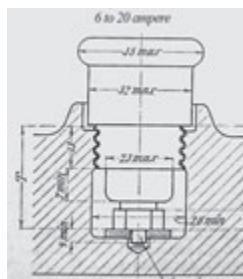

Fig. 2.3 – DIAZED dimension standard

Source: "Elektrotechnische Nachrichten" (May 1908)

³⁾ "Elektrotechnische Zeitschrift" (September 1882)

³⁾ "Elektrotechnische Zeitschrift" (1909, Issue 5)

³⁾ DIAZED is a registered trademark of Siemens AG

³⁾ "Elektrotechnische Nachrichten" (May 1909)

The result of the development work carried out by Siemens was launched under the brand DIAZED (Fig. 2.3), a name that combines the product's two key characteristics:

- Non-interchangeability by means of diameter gradings (**diametral**)
- **Z** from the German term "zweiteilige Ausführung" – or two-part design of the **Edison** insert, comprising an insert head and an exchangeable cartridge.

In many respects, the DIAZED concept was groundbreaking. Further laboratory and operational tests demonstrated its superiority so convincingly that, during its general assembly on June 8, 1909, the "Vereinigung der Elektrizitätswerke" nominated two-piece cartridge screw-type inserts as "the best design".⁷⁾

On top of this, many were impressed by the highly attractive design of the DIAZED fuse and the associated distribution boards (Fig. 2.4)⁸⁾.

A crucial factor in the overwhelming success of Siemens DIAZED fuses was a comparative study into the switching behavior of different fuse systems, which was conducted by the "Vereinigung der Elektrizitätswerke". In 1909, the test results and the operational experience gained since the fuse system was launched saw these two-piece, screw-type inserts for 500 V with indicator recognized as the best fuse system on the market⁴⁾.

As a result, Siemens assumed a leading role in the continued development of fuse systems designed to provide reliable protection for electrical installations.

That the DIAZED system received such an overwhelmingly positive response from electricity plants is no surprise when one considers its technical features, which not only helped it reach a global market but can also be found in many of today's successor products:

- Pressure-resistant porcelain body for high switching capacity
- Non-interchangeability by means of diameter grading
- Easy-to-read, reliable indicator
- Color coding
- Selectivity

To make it easier to monitor installations, the adapter sleeves and indicator were color coded. This color coding was based on the stamps that were in circulation at that time, which meant that everybody was already familiar with which colors were associated with which values (Fig. 2.5).

In 1927, the **N-DIAZED system** was developed. A more compact DIAZED design for currents of up to 25 A and a line supply voltage of 500 V, it required fewer materials to manufacture and less space in meter boards and small distribution boards. A smaller Edison thread (E 16) and ceramic adapter rings with an external thread (E 16) were introduced for this new

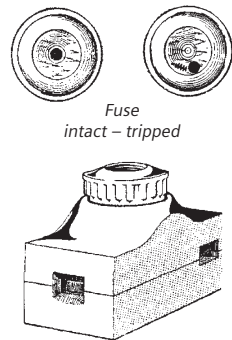

Fig. 2.4 – Practical and visually appealing: DIAZED 1907

Source: Wright, Newberry "Electric Fuses"



Fig. 2.5 – Easy-to-remember colors

⁷⁾ "Elektrotechnische Zeitschrift" (December 1909)

⁸⁾ A. Wright and P.G. Newberry: "Electric Fuses"

system instead of screw adapters. In this way, the fuse links came into direct contact with the base contact rather than via the screw adapter as was previously the case (Fig. 2.6).

1959 saw the introduction of the DIAZED system in other areas. Super-fast-acting characteristics were developed to protect semiconductor elements, for example, while slow-acting characteristics were developed for applications in the mining industry. In addition, 750 V fuses were developed for electric railways.

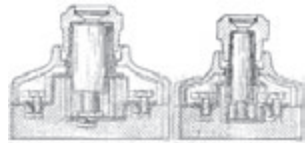

DIAZED with screw adapter
N-DIAZED with adapter ring

Fig. 2.6 – Compact
N-DIAZED system (1927)

Source: "Siemens-Zeitschrift" (February 1927)



D 01 D II D 02 D III
Fig. 2.7 – Comparison of the NEOZED(D0)
and DIAZED(D) fuse system

Source: "Siemens-Zeitschrift" 41 (1967), Issue 4

In 1967, a new fuse system optimized for line protection purposes was launched with the **NEOZED fuse system**⁹⁾. This new system was developed in response not only to the constant drive for more compact devices, but also the need to be able to adapt the dimensions in line with the module sizes in the already widespread modular installation devices. The basic design of the tried-and-tested DIAZED system was retained (Fig. 2.7):

- Screw cap
- Fuse link
- Adapter sleeve
- Fuse base

To differentiate between the NEOZED system and DIAZED system, the NEOZED system was assigned the dimensional designation "D0" (pronounced

"D zero"). Both versions have since been standardized globally as the "D system". In technical circles, a distinction is still made between D and D0 fuses or the brands DIAZED and NEOZED. The NEOZED system was characterized not only by its more compact size, but also by much lower power dissipation (power loss). This was due to 380 V being selected as the rated AC voltage, which was later raised to 400 V in accordance with the new, globally-standardized public supply voltage. A standardized characteristic (currently "gG") was also selected with selectivity capability from one rated current level to another, a grading that still largely applies to Siemens NEOZED fuses, even today.

The forerunners of the **LV HRC fuse system** were developed as early as the beginning of the 20th century¹⁰⁾. To manage rated currents of 100 A and more, which could no longer be handled by means of screw-in fuse-links, "plug-in porcelain cartridges" (fuse links with blade contacts) were developed (Fig. 2.8). The current designation "LV HRC fuse", however, was not coined until the 1920s.

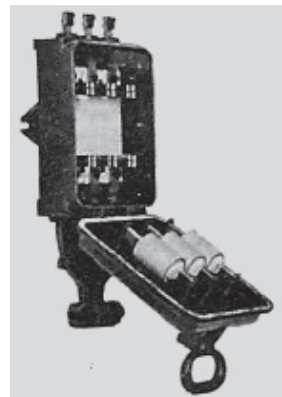

Fig. 2.8 – Plug-in porcelain car-
tridges (1910)¹⁰⁾

⁹⁾ NEOZED® is a registered trademark of Siemens AG

¹⁰⁾ "Elektrotechnische Zeitschrift" (September 1910)

From the middle of the 20th century, Siemens intensified its work on developing the LV HRC fuse. This resulted in:

- Greater switching capacity with smaller dimensions (size 00)
- Bus-mounting elements designed for state-of-the-art plant engineering
- Greater operational reliability thanks to standardized fuse pullers and fuse holders with load switching function (fuse switch disconnectors).

These groundbreaking developments meant that Siemens melting fuse systems could now be used internationally to protect power distribution networks fuse standards thanks to their compliance with the German DIN VDE standard and the international IEC standard (Fig. 2.9).

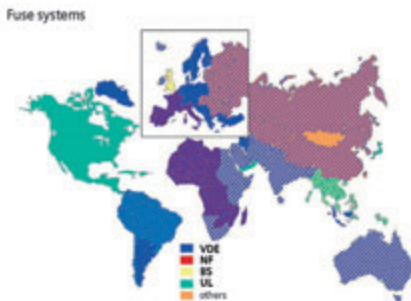

Fig. 2.9 – Map showing fuse standards thanks

3 Siemens Fuse Systems

The D and D0 screw-in fuse-link systems, which are currently marketed in compliance with international standards under the registered Siemens brands DIAZED and NEOZED, have their origins in the Siemens-Schuckert-Werke at the beginning of the 20th century. The “DIAZED” brand for electric melting fuses was registered in 1908 by the German Patent Office for the Siemens-Schuckertwerke GmbH, Berlin. Only original DIAZED fuses fulfill the stringent requirements of the Siemens quality standards.

The DIAZED system was extended to include the NDz fuse, a space-saving version designed for use in meter hoods, and the NEOZED system, a brand-new system designed to be compatible with modular installation devices.

Note: The names DIAZED and NEOZED are often used instead of the dimensional designations “D” and “D0”. Only original products, however, can be marketed under these brand names.

Siemens fuse systems are currently classified by design as follows:

- NEOZED system (D0 fuses D01 – D03)¹¹⁾
- DIAZED system (D fuses DII – DIV, NDz)
- LV HRC system
- Cylindrical fuse system
- Class CC fuse system

Fuse links are available for cable and line protection purposes in all of these systems and sizes. For the following special areas of application,

- Semiconductor protection (SITOR® and SILIZED® fuse links)¹²⁾
- Electrical motor circuits

fuse links are also available in different systems and standardized designs for semiconductor protection as well as in special designs.

¹¹⁾ In standards IEC 60269 and VDE 0636, the standard designations “D” and “D0” system are referred to as the “D” system. Siemens still considers it useful to retain the user-friendly differentiation between NEOZED and DIAZED due to the different installation conditions.

¹²⁾ SITOR®, SILIZED®, MINIZED®, and SENTRON® are registered trademarks of Siemens AG.

The following fuse combination units with load switching characteristics are available for

- MINIZED¹²⁾ switch disconnectors or NEOZED fuse switch disconnectors
- SENTRON¹²⁾

the NEOZED system and the LV HRC system:

The following section looks at the specific properties of the systems and their fields of application.

3.1 NEOZED and DIAZED Screw-In Fuse Link Systems

The Siemens screw-in fuse-link systems NEOZED and DIAZED comply with the international standard IEC 60269 and the German standards VDE 0636 and VDE 0635. The term “fuse” normally refers to the replaceable part of the fuse (fuse link), which is how the term is used here too. The standards, however, define a “fuse” as “all components that constitute the device as a whole”, that is, a screw-in fuse-link (Fig. 3.1.1) comprises:



Fig. 3.1.1 – Components of a NEOZED fuse

- The fuse base made of molded plastic or ceramic with a retaining device for the adapter sleeve and terminals
- The fuse link with a ceramic body, indicator (in the standard color), and a non-interchangeable front contact piece
- The screw cap (fuse carrier) made of molded plastic or ceramic, with inspection window and optional windows for checking the voltage and sealing
- The adapter sleeve (Fig. 3.1.2) with color coding in accordance with the rated fuse current, for insertion/removal by means of a special tool
- The touch protection cover made of molded plastic

The contact pieces on the fuse links must comprise at least 62% copper and be protected against corrosion by means of a galvanic coating. With rated currents of less than 50 A, the contacts are nickel plated; as of 50 A, a silver coating of at least 3 µm is required.

Key features of screw-in fuse-link systems are:

- Touch protection
- Non-interchangeability with respect to the rated current

This means that a fuse link whose rated current exceeds the permissible operational current of the application in question cannot be inserted accidentally into the fuse base. This ensures that the maximum permissible current load in a cable is not exceeded if a fuse with too high a rated current is used. This helps prevent hazardous overheating, which can trigger fires. Non-Non-interchangeability is required for rated currents greater than 10 A and is ensured by means of



Fig. 3.1.2 – Adapter sleeves

adapter sleeves (Fig. 3.1.2) in the base and graded diameters of the fuse contact pieces. Fuse links can only be inserted in bases with adapter sleeves of the same or greater rated current and can, therefore, be used by non-technicians too (Fig. 3.1.3). The adapter sleeves can only be installed and removed with the right adapter sleeve keys, however, which are only available to technicians.



Fig. 3.1.3 – Non-interchangeability

Safety information: Screw-in fuse-link systems that can be used by non-technicians are only available for voltage and current ranges that most non-technicians are likely to encounter in their day-to-day lives, such as domestic electrical installations. The limits in industrial applications are AC currents greater than 400 V and DC voltages greater than 25 V.

Restrictions also apply here for authorized persons with regard to removing and inserting D fuses under voltage (Table 3.1).



In VDE 0105-100 the German Standards Committee K 224 defined the limits (see Table 3.1) based on practical experiments. (The current values specified in Table 3.1 are the rated currents of the fuses, not residual currents that can occur when the fuses are inserted.) As a result, D and D0 fuses with a rated current of up to 63 A can be safely changed in low-voltage distribution networks by non-technicians too. In industrial networks with voltages in excess of 400 V, this is only permitted for authorized personnel at rated currents of up to 16 A.

With DC currents, fuses can only be safely replaced up to 25 V. With higher DC voltages, non-technicians are generally not permitted to replace fuses, and even authorized persons must observe strict rated current limits as of which fuses must only be changed once the power supply has been disconnected. With operational DC voltages greater than 25 V, even specialist technicians are forbidden to replace fuses under voltage when AC currents greater than 6 A (NEOZED fuses (D0 fuses)) or 16 A (DIAZED fuses (D fuses)) are present.

The original expectation that the NEOZED system would eventually surpass the DIAZED system as a new unified system remains unfulfilled to this day. It is, therefore, all the more important for users to have a complete overview of the systems currently used in electrical installations.

Table 3.2 provides an overview of the existing systems and their key characteristics: For the sake of completeness, the DL system is also mentioned. This was designed in accordance with a factory standard and is still widely used in installations in the new German federal states. Like NDz fuses, this system uses thread size E 16, although it is not interchangeable with this system. An adapter spring for DL screw caps allows NEOZED fuse links (size D01) to be used in existing installations with DL fuse bases.

Type	Rated voltage	Non-techn.	Auth. persons
D, D0	≤ 400 V a.c.	≤ 63 A	≤ 63 A
D	> 400 V a.c.	No	≤ 16 A
D, D0	≤ 25 V a.c.	Yes	Yes
D0	25 V to 60 V d.c.	No	≤ 6 A
	> 60 V to 120 V d.c.	No	≤ 2 A
	> 120 V d.c.	No	No
D	> 25 V to 60 V d.c.	No	≤ 16 A
	> 60 V to 120 V d.c.	No	≤ 5 A
	> 120 V to 750 V d.c.	No	≤ 1 A
	> 750 V d.c.	No	No

Table 3.1 – Permissible fuse replacement under voltage ¹³⁾

¹³⁾ Explanations of VDE 0105-100

Siemens system	Size	Thread	Rated currents	Rated voltage	Switching capacity	Standards
NEOZED	D01	E 14	2 A to 16 A	400 V a.c. 250 V a.c.	50 kV a.c. 8 kV a.c.	VDE 0636
	D02	E 18	20 A to 63 A			
	D03	M 30x2	80 A and 100 A			
DIAZED	DII	E 27	2 A to 25 A	500 V a.c. 500 V a.c.	50 kV a.c. 8 kV a.c.	VDE 0636
	DIII	E 33	35 A to 63 A			
	DIV	G 1 ¼	80 A and 100 A	500 V a.c. 500 V a.c.	4 kV a.c. 1,6 kV a.c.	VDE 0635
	NDz	E 16	2 A to 25 A			
Accessories ^o	DL	E 16	2 A to 20 A	380 V a.c.	20 kV a.c.	WN

Table 3.2 Siemens screw-in fuse-link systems

The DIAZED system was the first Siemens fuse system to be developed and remains to this day the world's most widely used system. As such, it is a key element of Siemens fuse systems that covers voltage ranges and applications that were no longer taken into account by more efficient successor products. These also contain fuse types that are not covered by the international standard IEC 60269 or the harmonized German standard VDE 0636. This is the case with NDz fuses, for example, which, due to the fact that they are suitable for high DC voltages, are still used to this day in measuring and control circuits. These fuses are available with fast-acting and slow-acting characteristics (TNDz), and are standardized in German standard VDE 0635.

The DIAZED system encompasses rated voltages of up to 750 V a.c. and 750 V d.c. as well as rated currents of between 2 and 100 A.

Thanks to its wide range of characteristics from super-fast acting to slow acting (Fig. 3.1.4) and its suitability for DC voltages, the DIAZED system is the most flexible of all Siemens fuse systems (Table 3.3).

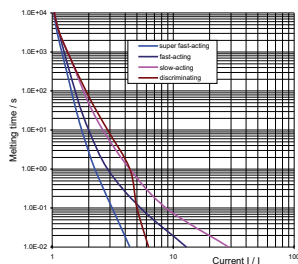

Fig. 3.1.4 – DIAZED® characteristics

Size	DII	DIII	DIV	DIII	NDz	DIII
Standards	IEC 60269, VDE 0636				VDE 0635	
Thread	E 27	E 33	E 33	G 1 ¼	E 16	E 33
Max. rated current	25 A	63 A	63 A	100 A	25 A	63 A
Rated voltages	500 V a.c. 500 V a.c.	500 V a.c. 500 V a.c.	690 V a.c. 600 V a.c.	500 V a.c. 400 V a.c.	500 V a.c. 500 V a.c.	700 V a.c. 750 V a.c.
Switching capacity	50 kV a.c. 8 kV a.c.	50 kV a.c. 8 kV a.c.	50 kV a.c. 8 kV a.c.	50 kV a.c. 8 kV a.c.	40 kV a.c. 1,6 kV a.c.	10 kV a.c.
Operational classes, characteristics	gG, gR fast acting (VDE 0635) super-fast acting	gG, gR fast acting (VDE 0635) super-fast acting	gG	gG, gR fast acting (VDE 0635) super-fast acting	low acting (TNDz), fast acting	fast acting (electric railways)

Table 3.3 – DIAZED® fuse system

¹⁴⁾ The DL retaining spring enables NEOZED® fuse links D01 from 2 – 16 A to be inserted in DL fuse holders.

Note: As with all standardized fuse bases, the power that can be absorbed by DIAZED fuse bases is coordinated in line with the power dissipation of line protection fuses (gG fuses). At the same rated current, the super-fast-acting DIAZED fuse links SILIZED for semiconductor protection (gR fuses) have a much greater level of power dissipation than gG fuses. They are indicated by a yellow ring to prevent confusion (Fig. 3.1.5). When these fuse links are used, the maximum power that can be absorbed by the fuse base must always be noted.



Fig. 3.1.5 – SILIZED® semiconductor fuse

The DIAZED system is a carefully coordinated and harmonized modular system, the components of which can be combined in almost any possible way in order to fulfill any installation requirements (Fig. 3.1.6). It is particularly suitable for use in harsh environments.

As modular installation devices, the DIAZED bases are installed in distribution boards (acc. to DIN 43880) or on a standard mounting rail (acc. to EN 50021). The busbar system with an oblong hole (Fig. 3.1.6) can be loaded up to 80 A and is particularly easy to install. With the specially developed busbar system with side infeed, the high-performance EZR bus-mounting system for screw fixtures can be loaded up to as much as 150 A.

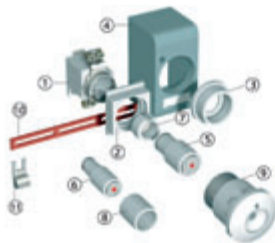

Fig. 3.1.6 – DIAZED® system components

Legende:

- 1 DIAZED base
- 2 DIAZED cover
- 3 DIAZED cover ring
- 4 DIAZED cap
- 5 DIAZED fuse link DII
- 6 DIAZED fuse link NDz
- 7 DIAZED screw adapter
- 8 DIAZED adapter sleeve
- 9 DIAZED screw cap
- 10 Busbar, oblong hole, 1-phase
- 11 Terminal, fork-type terminal, non-insulated

The NEOZED system is specially designed to be installed in distribution boards and builds on the positive response to the DIAZED system. Non-interchangeability and touch protection are standard features. Non-interchangeability is ensured by means of metal adapter sleeves with an indicator color (adapter sleeves, Fig. 3.1.2). These are secured in the fuse base by means of springs and can only be replaced with a special adapter sleeve key (see Fig. 3.1.9). The adapter sleeves do not carry any current and are de-energized when the fuse link has been removed. The contact piece on the fuse link, therefore, makes direct contact with the contact on the base without any additional transfer resistance.



Fig. 3.1.7 – NEOZED® modular system

Since the dimensions are adapted to the dimensions specified in DIN 43880 for modular installation devices, fuse distribution boards can be more easily configured and installed, and fuses can be more easily combined with other modular devices (Fig. 3.1.7).

The grading of the three sizes for the rated current range of 2 A to 100 A is optimized according to the prospective sales volumes. Since the range from 2 A to 16 A is the most popular, size D01 is limited to this rated current range. This results in an extremely cost-effective and compact design based on the Edison thread E 14.

Similarly, the electrical rated values are also optimized in line with the main requirement of the market which, in this case, is a rated voltage of 400 V a.c. (250 V d.c.) and a standardized characteristic (gG) adjusted in line with the load-carrying capacity of cables and lines. The lower rated voltage (vis-à-vis the DIAZED system) allows for less creepage/clearances and power dissipation. Both are designed to optimize the use of space in distribution boards (Table 3.4).

Fuse system	Size / thread	Rated current range	Max. power dissipation	Module width
NEOZED® system	D01 / E 14	2 A to 16 A	2.5 W	27 mm (1.5 MW)**
	D02 / E 18	20 A to 63 A	5.5 W	27 mm (1.5 MW)*
	D03 / M 30x2	80 A to 100 A	7.0 W	45 mm (2.5 MW)
DIAZED® system	DII / E 27	2 A to 25 A	4.5 W	39 mm
	DIII / E 33	32 A to 63 A	7.0 W	46 mm
	DIV / G 1¼	80 A to 100 A	9.0 W	48 mm

* Module width 18mm (1 MW) with D01 Withdrawable fuse disconnectors

Table 3.4 – Dimensions and power dissipation of NEOZED and DIAZED system

Note: As with all standardized fuse bases, the power that can be absorbed by NEOZED fuse bases is coordinated in line with the power dissipation of line protection fuses (gG fuses). At the same rated current, the super-fast-acting NEOZED fuse links SILIZED for semiconductor protection (gR fuses) have a much greater level of power dissipation than gG fuses. As with DIAZED, they are indicated by a yellow ring to prevent confusion (Fig. 3.1.5). When these fuse links are used, the maximum power that can be absorbed by the fuse base must always be noted.

Featuring a wide range of component variants, NEOZED is a fuse system that can be deployed universally (Fig. 3.1.9). Depending on the application, operators can choose between the following options:

- Bases made of molded plastic or ceramic
- One and three-pole bases
- Rail-mounting or screw fixture
- Input/output terminals for all conductor shapes and cross-sections
- Snap-on or screw-type molded plastic covers
- Screw caps made of molded plastic or ceramic
- Screw caps with inspection hole or sealable (Fig. 3.1.8).



Fig. 3.1.8 – NEOZED® screw caps

Busbars that allow the bases to be supplied in parallel make installation easier without reducing the wire connection options (see section "3.3 Busbar Systems").



Bild 3.1.9 – NEOZED system components

The NEOZED system also features the NEOZED fuse switch disconnectors (Fig. 3.1.10) and MINIZED fuse switch disconnectors with fuses, which are fuse combination units developed from the fuse components and used in applications covered by the standards IEC 60947-3 and VDE 0660, Part 107. The special features of these switching devices are described in more detail in section 3.6.

What both device families have in common is that the fuse links are not actuated by means of the screw cap but are instead placed in their operating position by means of their draw-out design. This increases operational safety because fuses can be replaced while de-energized and, in the case of D01, the mounting width can be reduced to 18 mm in accordance with the module width (see Table 3.4).

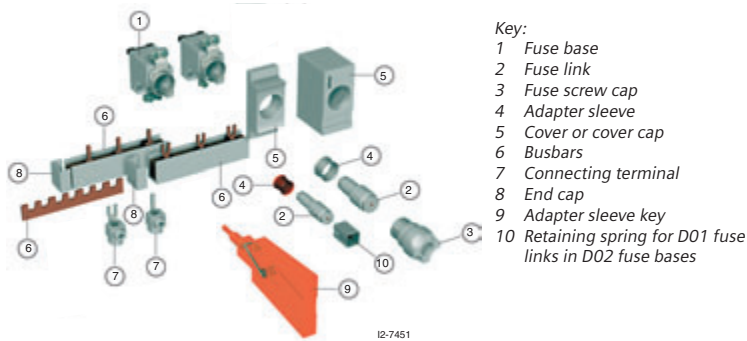

Fig. 3.1.10 – Just 18 mm wide: MINIZED fuse switch disconnectors

3.2 LV HRC fuse system

The LV HRC fuse (Fig. 3.2.1) comprises (as per the relevant standard):

- The **fuse base** with contacts for the blade contacts reinforced by separate springs
- The **fuse link**, the core of the protective device
- The fuse carrier, available as a **fuse puller**
- **Slewing equipment** for actuating the fuse link in a controlled movement

The fuse base and slewing equipment combined create a **Sicherungshalter** (see also section "3.6 MINIZED and SENTRON Load Interrupter Switches with Fuse").

Siemens has developed these basic components to create a universal system for protecting electrical power distribution systems with accessories for a wide range of different installation conditions (Fig. 3.2.9).



Bild 3.2.1 – LV HRC fuse

The LV HRC fuse system is designed for use by **authorized persons**, who must be either qualified electricians or trained in electrical engineering. For this reason, the systems do not have to be touch protected or non-interchangeable. Despite this, however, this highly-practical Siemens LV HRC system, which was developed in close collaboration with the customer, is generally also shipped with touch-protection accessories. The dimensions of the LV HRC fuse puller and its interaction with the fuse links is standardized in accordance with VDE 0636-201. Fuse pullers designed for actuation under live conditions are equipped with protection for the forearms and fall within the scope of VDE 0680-4.

LV HRC fuse links

The basic design of Siemens LV HRC fuse links along with their key functional components are shown in Fig. 3.2.2:

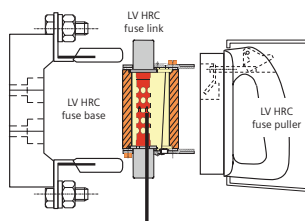
- The **contact pins** are made of solid copper with silver-coated surfaces. This ensures highly durable, corrosion-free contacting with low transfer resistance and a fuse with a low level of power dissipation (power loss). If the device is intended for use in industrial environments that attack the silver coating, other surface coatings may be required. These generally reduce the load-carrying capacity of the fuse and should only be chosen after consulting the Siemens Customer Service Center.
- The bright red **indicator** makes it easier to find and replace fuses that have tripped and cuts downtime after plant malfunctions. The indicator is triggered when the indicator wire melts. Siemens LV HRC fuses are fitted as standard with a front-side top indicator. The design of this indicator has proved to be highly reliable, easy to install, and easily visible in open distribution boards. The Siemens combination alarm with an end and front-side indicator (Fig. 3.2.3) is even more visible because it changes color from red to white on the front.
- It is also highly visible when used in safety switching devices and enclosures that offer only a restricted view. In the standard version, **grip lugs** are an integral component of the cover plates. The de-energized versions, which are indicated by the printed "hammerhead symbol" (Fig. 3.2.3), offer protection against accidental contact and jumpering for live components. The de-energized grip lugs are also made of metal, which makes them mechanically robust and unbreakable even at low temperatures.
- The **fuse element** is the core component of a fuse. It governs the switching characteristics and is responsible for the temperature rise. It is manufactured with a high level of precision from a pure copper strip. A uniform thickness of the strip, good conductivity, with combination alarm compliance with the characteristics and low power dissipation (power loss). The maximum power dissipation values for standard LV HRC fuse links are listed in Table A.4.5.2 in the appendix. The number of limiters in series is based on the magnitude of the recovered voltage (line supply voltage) and/or the rated voltage of the fuse.

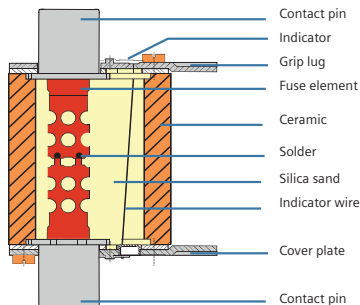

Fig. 3.2.2 - LV HRC fuse link



Fig. 3.2.3 – LV HRC fuse links with combination alarm

- The **insulator** prevents hot gases and liquid metal from escaping when the fuse trips and must be able to withstand very high temperatures, rapid temperature fluctuations, and high internal pressures. For standard Siemens fuses, it is made of steatite; for SITOR semiconductor fuses, which are subject to high thermal stress, however, it is made of Al_2O_3 ceramic.
- The **solder** is used in full-range fuses. It is selected in line with the fuse element material and must be available in the right quantity in the right place. An internal connection is needed for the solder to react with the fuse element. Lead and cadmium-based solders, which used to be widespread, are no longer used in Siemens fuses (see 4.1 for functional details).
- Together with the ceramic body, the **cover plates** form a pressurized enclosure for the arc.
- The **silica sand** filling is essential for current-limiting tripping. Siemens fuses are filled with crystal silica sand with a high level of chemical and mineralogical purity. Fire-drying is used to separate it from crystal water. A set grain size distribution and optimum compaction, which are subject to strict controls, are essential for ensuring that the fuse functions reliably.

LV HRC fuse handle (LV HRC fuse puller)

The introduction of a standardized fuse puller meant that the operational reliability of the LV HRC system could be increased to the extent that persons trained in electrical engineering could now actuate LV HRC fuses even when the system is live.

The actuation of LV HRC fuse links under load is not accommodated in the fuse standard. Despite this, however, the LV HRC system is suitable for occasional load switching. The use of LV HRC fuse links as a moving contact piece offers significant benefits for network operators. LV HRC fuses deployed as protection and switching elements make it much easier to manage networks, particularly when it comes to disconnecting or reconnecting cables in meshed networks.

Note: If the fuse link has been removed or when the switching position is open, LV HRC bases with and without slewing equipment fulfill the isolating point conditions and can, therefore, be used to disconnect the circuit.

Specifications regarding the actuation of LV HRC fuses under load can be found in the following standards:

- The German accident prevention regulations "Elektrische Anlagen und Betriebsmittel" (electrical installations and equipment") BGV A 3 (formerly VBG 4)¹⁵⁾,
- VDE 0105-100 "Betrieb von elektrischen Anlagen" (operation of electrical installations)
- VDE 0680-4 "NH-Aufsteckgriffe" (LV HRC fuse pullers)

A strict differentiation is made between non-technicians and authorized persons with regard to the actuation of fuses under load. Authorized persons are:



Fig. 3.2.4 – Actuating LV HRC fuse links under load

Source: BGFE Berufsgenossenschaft der Feinmechanik und Elektrotechnik

- Qualified electricians: Persons who, due to their technical training, knowledge, experience, and knowledge of applicable guidelines, are able to properly assess the work they are assigned and identify any potential hazards. Qualified electricians will have usually successfully completed training in electrical engineering.
- Persons who have received instruction in electrical engineering: Persons who have been trained by experts to perform specific activities and are supervised (operating and service personnel) to ensure that they are able to identify and avoid hazards associated with electrical currents.



Fig. 3.2.5 – LV HRC fuse puller with sleeve

LV HRC fuses must only be actuated under load by authorized persons using the standardized LV HRC fuse puller with sleeve (Fig. 3.2.5) and the prescribed body protection (Fig. 3.2.4). Officially-approved handles with forearm protection bear an insulator symbol (Fig. 3.2.6).



Fig 3.2.6 – Insulator symbols

Note: Operators must always check LV HRC fuse pullers with forearm protection (sleeve) for any signs of damage or other visible defects before using them.

According to the German accident prevention regulations BGV A3, work is permitted to be carried out on fuses under load provided that any risk of electric shock or arcing has been excluded. This condition is considered fulfilled when LV HRC fuse pullers with a securely attached sleeve are used and a helmet with a face mask is worn (Fig. 3.2.4).

Under normal circumstances in distribution networks with LV HRC fuses, trained experts or persons trained in electrical engineering are permitted to interrupt circuits up to the rated fuse current. Even unintentional fault throwing should not cause any major problems for trained personnel provided that they use the handle with sleeve and wear a face mask in accordance with the relevant guidelines.

If occasional overcurrent switching is necessary and if high fault powers are present, LV HRC fuse links can be installed in fuse switch disconnectors (acc. to VDE 0660-107 "Schalter-Sicherungs-Einheiten") (switches, disconnectors, switch-disconnectors and fuse-combination units) for switching purposes (see section 3.6).



Safety information: LV HRC fuse links for load switching with the LV HRC fuse puller or as a contact piece in LV HRC fuse switches must be equipped with suitable, solid copper or copper-alloy contacts. Hollow and aluminum contacts have proved to be unsuitable and potentially dangerous because they can be destroyed far too easily by arcs and can induce arc faults.

LV HRC fuse bases

LV HRC fuse bases are the most important mechanical and electrical link between the fuse and the switchgear assembly or distribution board. To a large extent, they determine the dimensions of electrical installations as well as the amount of time and effort required to set them up. The LV HRC fuse base contacts (Fig. 3.2.7) also significantly influence the operational reliability of an installation. The Siemens LV HRC fuse bases with Lyra contacts reinforced by separate springs ensure safe and reliable operation over the long term thanks to their highly-effective properties:

- Reliable current transfer over the long term with minimal rise in temperature thanks to silver-coated contact surfaces and a strong steel spring washer. The spring washers are mechanically zinc plated, which helps prevent them from fracturing due to hydrogen embrittlement.
- The LV HRC fuse links are easy to operate despite high contact force thanks to wide, parallel contact surfaces.

Note: To prevent corrosion and minimize the actuating force, a small amount of vaseline or other suitable grease should always be applied to the contact surfaces.

- The “pinch effect” of the Lyra contacts ensures a high dynamic retention force when short-circuit currents are present. Since the current is distributed across two parallel contact legs, this generates a magnetic attractive force that presses the contact surfaces against the knife contact of the fuse and prevents the fuse link from catapulting out of the fuse base if high short-circuit currents are present (Fig. 3.2.7).
- Large, parallel contact surfaces ensure that heat is effectively transferred from the fuse link to the fuse base and the connected conductors. The heat generated when the LV HRC fuse links are in operation is dissipated mainly via contact of the fuse base contacts and the connected conductors into the atmosphere. Effective heat dissipation minimizes operating temperatures, increases the service life of the contacts, and protects nearby molded-plastic covers against thermal damage. (The maximum values for the power that can be absorbed by LV HRC fuse bases are listed in Table A.4.5.2 in the appendix.)
- The high mechanical and thermal stability of the contact carriers helps ensure that the contacts do not become twisted or loosened during installation or as a result of brief increases in temperature during overcurrent switch-off.
- A sophisticated design and conductor connection concept ensures compatibility with any form of conductor and allows optimization in line with different plant requirements.
- Insulating barriers and covers provide protection against accidental contact and jumbling for nearby live components.

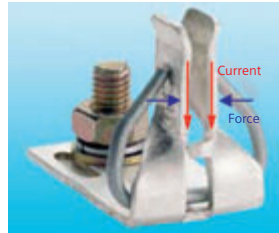

Fig. 3.2.7 – Lyra contact of an LV HRC fuse base

The LV HRC system features fuse bases in different sizes along with the matching fuse links. Size LV HRC 4, however, is an exception here because it is equipped with screwed contacts. It has largely been superseded by size LV HRC 4a, which is equipped with blade contacts. Size LV HRC 0 must only be used when a replacement is required. Exceptions here are fuses with striker indicators, which are still also permitted in new installations.

If the fuse link carrier on the fuse base is supported mechanically, it is known as slewing equipment (Fig. 3.2.8). The fuse base and slewing equipment together form a fuse holder, which fulfills the requirements for a fuse disconnecter to VDE 0660-107 and is indicated by means of a special symbol (Table 3.10). With size 4a LV HRC fuses, the slewing equipment must be fitted with a lock.



Fig. 3.2.8 – Fuse holder (fuse base with slewing equipment)

A separate, standardized fuse base is not available for size LV HRC 000 (formerly LV HRC 00C). Size 000 fuse links fit in size 00 fuse bases, although the benefits of the more compact dimensions as defined within the scope of the relevant standard cannot be leveraged here. Fuse bases and fuse switching devices (e.g. Siemens SENTRON LV HRC 000 switch disconnecter) that are outside the scope of the standard are, however, available and allow operators to benefit from a more compact design with lower rated currents. Siemens is one of the few manufacturers that offers size 000 up to 160 A.

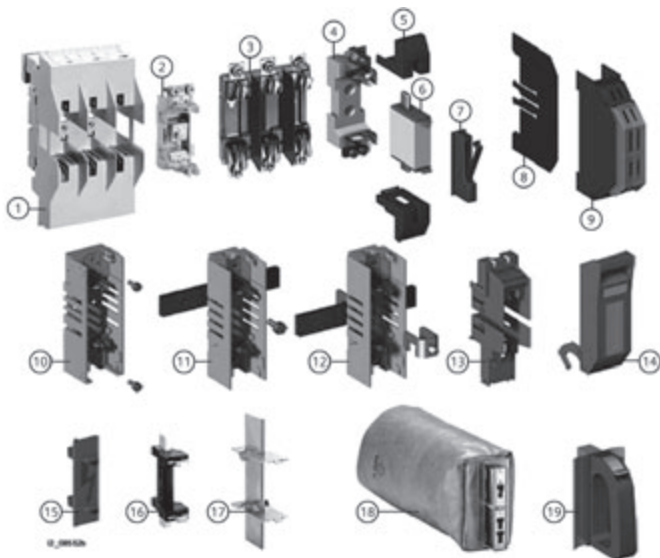

LV HRC fuses comprise the following components:

- 1 LV HRC fuse base in the busbar system range SR60
- 2 LV HRC fuse base for busbar mounting
- 3 LV HRC fuse base, 3-pole
- 4 LV HRC fuse base, 1-pole
- 5 LV HRC contact covers
- 6 LV HRC fuse link
- 7 LV HRC signal indicators
- 8 LV HRC partition
- 9 LV HRC protective cover

LV HRC fuse bases with slewing equipment

- 10 – For screw fixing on mounting plate
- 11 – For screw fixing on busbar system
- 12 – For claw fixing on busbar
- 13 LV HRC protective cover for LV HRC fuse bases with slewing equipment
- 14 LV HRC slewing equipment
- 15 LV HRC fuse base cover
- 16 LV HRC isolating link with insulated grip lugs
- 17 LV HRC isolating link with non-insulated grip lugs
- 18 LV HRC fuse puller with sleeve
- 19 LV HRC fuse puller

Fig. 3.2.9 – Comprehensive range of LV HRC accessories

3.3 Busbar Systems

Once simply a built-in component, LV HRC fuse bases have been constantly optimized in line with customer requirements to become a key design element in switchgear assemblies and distribution boards. One important focus of development concerned adapting fuse bases for busbar systems. Busbar systems allow fuse bases and other installation devices to be arranged clearly and compactly in power distribution boards.

The **bus-mounting fuse bases** sit directly on the busbar, whereby the busbar-side power connection also acts as a mechanical fixture for the fuse base. As such, this is an excellent means of leveraging the benefits of the busbar concept in power distribution boards with fuses.

They offer the following benefits:

- **Optimum use of space**, which means that more devices can be installed or a smaller enclosure used.
- **Cost-saving installation** because mechanical fixing and electrical contacting is effected in one step.
- **Fewer contact points** and transfer resistors, which results in...
- **High level of operational reliability**

The two most important designs for the LV HRC fuse bases developed in Germany for direct busbar mounting are:

- LV HRC fuse strips in sizes 00 to 3 for busbar systems with center-to-center distances of 100 mm and 185 mm
 - Single and tandem fuse bases in size 00 for busbar systems with a center-to-center distance of 40 mm.
- This has since become the industry standard (IEC 60269).

From a central infeed, tandem fuse bases (Fig. 3.3.1) have one LV HRC fuseway routed upwards and one routed downwards for each phase. A maximum rated current of 63 A has been defined for the fuseways. Tandem and single bus-mounting fuse bases are used particularly in meter cabinets (Fig. 3.3.2).

In addition to the standardized bus-mounting fuse bases, Siemens has also adapted LV HRC fuse switch disconnectors for direct installation on busbars with a center-to-center distance of 40 mm and 60 mm.

For an overview of standard busbar systems with their dimensions and areas of application, see Table 3.5.

Busbar systems with a center-to-center distance of 100 mm and 185 mm are mainly used in transformer stations, cable distribution cabinets, and small distribution boards in public power distribution networks. The busbar distances are adapted in line with the overall lengths of LV HRC fuse links LV HRC 00 (100 mm) and LV HRC 1 to 3 (185 mm), which results in a much more cost-effective design of the 3-pole LV HRC fuse bases (LV HRC fuse strips). The linear arrangement of the fuses in LV HRC fuse strips or LV HRC in-line fuse switch disconnectors optimizes the use of space available on the busbar.



Fig. 3.3.1 – Tandem fuse base



Fig. 3.3.2 – Meter cabinet

Application	Center-to-center distance of busbars	Standard	Rated current range	Busbar height
Modular installation devices	–	Factory standard	Up to 130 A	–
Meter distribution boards	40 mm	DIN 43870	Up to 400 A	12 mm
Building and industrial power distribution	60 mm	Factory standard	Up to 630 A	12 to 30 mm
Public power distribution networks	185 mm 100 mm	IEC 60269	Up to 2500 A	Variable (up to 100 mm)

Table 3.5 – Busbar systems

Mounting widths of 50 mm for fuse size LV HRC 00 and 100 mm for fuse sizes LV HRC 1 to 3 have established themselves as the standard dimensions, thereby making it easier to configure and manufacture installations. Busbar systems with LV HRC fuse strips are particularly suitable for distribution boards with more than one similarly-sized cable outlet (Fig. 3.3.3). The busbar cross-sections are selected in accordance with the thermal rated current. When fuses are used, short-circuit loads do not generally need to be taken into account because the busbar distances are relatively large and the connected LV HRC strips provide additional mechanical stability. The mounting height required by the LV HRC fuse strips generally allows for just one operator level in each distribution board.

The **Siemens SR60 busbar system** with a center-to-center distance of 60 mm is a compact and highly flexible system for installation distribution boards in functional and industrial buildings (Fig. 3.3.4). Thanks to the low mounting height, a number of systems can be placed on top of each other in a distribution board.



Fig. 3.3.4 – Bus-mounting elements on the SR60 busbar system



Fig. 3.3.3 – Distribution board with LV HRC in-line fuse switch disconnectors

Thanks to its compact, modular design, the SR60 busbar system can be equipped with a wide range of quick-fit flexible connection, switching, and modular installation devices (Figs. 3.3.4 and 3.3.5). A busbar system is usually supplied via an LV HRC fuse switch disconnector (Fig. 3.3.4, left) or via terminals (Fig. 3.3.5, no. 3) with suitable back-up fuses. The SR60 busbar system from Siemens fulfills not only the international IEC standards requirements but also the North American UL standard*, which means that it can be used virtually anywhere in the world.

* Details of UL-approved system components can be found in catalog LV 16..

The technical design of busbar systems takes into account three current load criteria:

- The **rated current** is a measure of the continuous current-carrying capacity of the busbar system. The limit temperatures specified in the relevant standard are observed at this operational current. The actual load-carrying capacity can vary depending on the installation conditions (ambient temperature, ventilation, position of busbars, etc.). For this reason, the values listed in Table 3.6 should be used as a guide only. In the limit ranges of the load-carrying capacity, a center infeed can provide thermal relief for the busbars. A similar effect can be achieved (albeit with a little more effort) by supplying both ends of the busbars
- When **over current protection** is provided by means of current-limiting fuses in accordance with Table 3.6, the rated short-time current-carrying capacity is irrelevant.
- The **rated impulse withstand current** must be greater than the potential peak value of a short-circuit current and/or the let-through current of the upstream fuse (see sections 4.1 and 4.3).

CU busbar dimensions H/mm x D/mm	Continuous current at 35°C	Operational class (gG) of back-up fuse
12 mm x 5 mm	200 A	200 A
12 mm x 10 mm	360 A	315 A
15 mm x 5 mm	250 A	250 A
15 mm x 10 mm	447 A	400 A
20 mm x 5 mm	320 A	315 A
20 mm x 10 mm	520 A	500 A
25 mm x 5 mm	400 A	400 A
25 mm x 10 mm	580 A	500 A
30 mm x 5 mm	447 A	400 A
30 mm x 10 mm	630 A	630 A

Table 3.6 – Continuous current-carrying capacity of SR60

The compact design of the SR60, particularly the relatively small busbar distances, requires busbar supports that are mechanically and thermally stable and offer sufficient electrical insulation. For this reason, SR60 busbar supports have a three-pole design and are made of glass-fiber-reinforced thermoplastic polyester. Because no drilling is required to secure the busbars, the length between the busbar supports can be chosen as required. The limits of the dynamic short-circuit strength must be taken into account, however. These depend on the distance between the busbar supports and on the busbar cross-section. When the busbar supports are installed on longitudinal bars, however, the panel widths and, in turn, the possible distances are predefined. The product documentation for the SR60 contains all the required configuration guidelines in detail.

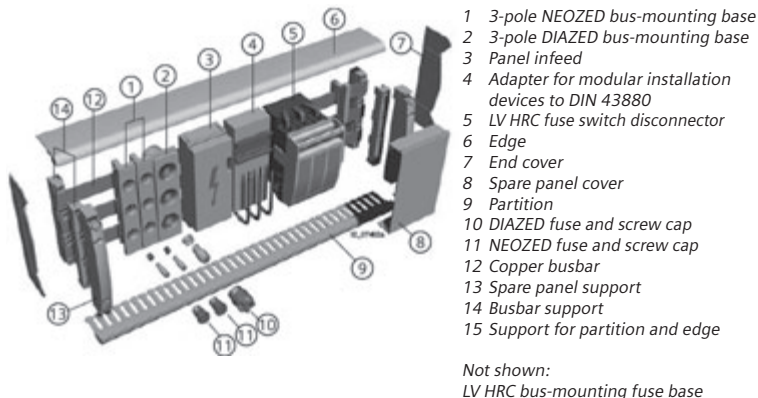

Fig. 3.3.5 – SR60 busbar system

Busbar systems for modular installation devices are generally only used for power distribution purposes, which is why they are also known as comb-type bars (because of their design) or wiring bars (because of their function). The fuse bases are secured mechanically to the mounting rail (acc. to EN 50021) or as a screw fixing on mounting plates. The key selection criteria are:

- Rated current (busbar cross-section, current carrying capacity)
- Outgoing feeder type (fork or pin type)
- Number of poles (1–4 pole, (1+N) pole, (3+N) pole)
- Additional equipment (auxiliary switch and fault signal contact)

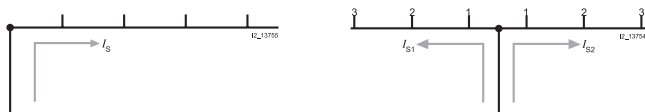

Fig. 3.3.6 – Busbar infeed

The busbars available for devices with fuses are one meter long as standard but can be shortened to the required length by the installation engineer. Shorter busbars with a length of 12 MW (standard for MCB circuit breakers) can be used for devices with a mounting width of 18 mm, NEOZED fuse switch disconnectors, and cylindrical fuse holders.

In modern modular installation devices, the busbars are clamped at the rear and the wire connection is positioned without additional feeder terminals in front of the busbar connection (Fig. 3.3.7). This makes it much easier to feed in the conductors and carry out visual inspections, thereby reducing the time and effort involved in installation while boosting operational reliability.

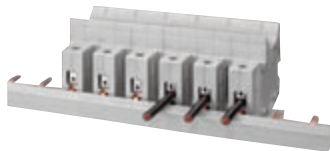

Fig. 3.3.7 – NEOZED fuse base on busbar

The total combined outgoing currents and the infeed current I_E in a busbar system can be increased by around 60% by positioning the infeed in the middle of the busbar instead of at the start (Fig. 3.3.6 and Table 3.7).

Busbar cross-section	Infeed on side	Infeed in middle
10 mm ²	63 A	100 A
16 mm ²	80 A	130 A

Table 3.7 – Infeed current I_E

3.4 Cylindrical Fuse System and Class CC Fuse System



Safety information: Like the American class CC fuse system, the Siemens cylindrical fuse system in Germany is approved only for use in industrial plants and switching cabinets in which fuses are replaced by trained personnel.

Cylindrical fuse systems are equipped with fuse links with cylindrical contact caps. They are classified according to size in line with the dimensions of the fuse links (diameter x length) (Table 3.8). Cylindrical fuses are inserted in fuse holders, the shape and dimensions of which conform to the modular installation device standard (Fig. 3.4.1). The devices with sizes 8 x 32 and 10 x 38 up to 20 A or 32 A have the compact dimensions of one modular width (18 mm) for each pole. Version 1 + N also only requires one modular width. This means that the module width is much less than that of the NEOZED and DIAZED fuse bases and further optimizes the use of space in installation distribution boards. To make it easier to locate fuses that have tripped, the supports can be fitted with signal indicators that signal a tripped fuse by means of a flashing LED. Space for a replacement fuse in the withdrawable part (Fig. 3.4.1) means that fuses can be replaced and the system restored after a malfunction more quickly.

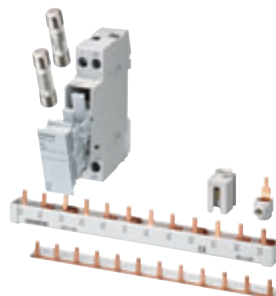

Fig. 3.4.1 – Cylindrical fuse system

Size (mm x mm)	8 x 32	10 x 38	14 x 51	22 x 58
Rated voltage	400 V a.c.	500 V a.c. (400 V a.c.)	500 V a.c. (400 V a.c.)	500 V a.c. (400 V a.c.)
Rated current gG	Up to 20 A	Up to 25 A (32 A)	Up to 40 A (50 A)	Up to 80 A (100 A)
Rated current aM		Up to 20 A (25 A)	Up to 40 A (50 A)	Up to 80 A (100 A)
Rated breaking capacity	20 kA	100 kA (20 kA)	100 kA (20 kA)	100 kA (20 kA)

Table 3.8 – Siemens cylindrical fuses

The fuse holders in the cylindrical fuse system fulfill the requirements regarding fuse disconnectors in accordance with utilization categories AC 20 B and DC 20 B to IEC 60947-3. They are not suitable for load switching. When the withdrawable part is removed, the fuse links can be safely replaced by the operator. Despite this, however, the system is not suitable for non-technicians because there is a risk of confusing the different, internationally-standardized systems. This is why the cylindrical fuses have not been included in the VDE regulations and do not carry the VDE mark of conformity.

Cylindrical fuses are standardized in the international standard IEC 60269 and, as well as in Germany, are particularly popular in Great Britain, France, and Southern Europe. The systems are suitable for use by non-technicians in domestic electrical installations ("household fuses") with a relatively low switching capacity (6 kA to 20 kA), and for use by persons trained in electrical engineering in industrial applications with switching capacities of 50 kA and higher.

International fuse standard	System	Dimensions [mm x mm]	Rated voltage	Switching capacity	Rated current range
IEC 60269-2 *	F	10 x 38	690 V a.c.	50 kA	Up to 25 A
IEC 60269-3 **	B	10 x 38	400 V a.c.	20 kA	Up to 32 A
	C	9,5 x 35	240 V a.c.	20 kA	Up to 45 A
	D	10,2/9,8 x 38	400 V a.c.	20 kA	Up to 32 A
UL 248-4 *	Class CC	10 x 38	600 V a.c.	200 kA	Up to 30 A
UL 248-14 *	Midget	10 x 38	125 V a.c. to 600 V a.c.	10 kA	Up to 30 A

* Fuses designed for use by persons trained in electrical engineering (mainly industrial applications)
 ** Fuses designed for use by non-technicians (mainly domestic electrical installations)

Table 3.9 – Interchangeable cylindrical fuses 10 x 38

Cylindrical fuse links for use by non-technicians (IEC 60269-3) are non-interchangeable within the different systems with respect to the rated current intensities. At a cross-system level, however, fuse links with the same (or nearly the same) dimensions are interchangeable. This also applies to North American cylindrical fuse systems that were not included in IEC 69269.

Due to the risk of confusion and the potentially dangerous consequences, a European standard (EN) has not been defined for these fuse systems. Instead, the different systems are described in a "harmonization document" (HD) from which individual systems are selected for the national standards.

Table 3.9 provides an (incomplete) overview of internationally-standardized cylindrical fuse systems with the popular dimensions 10 x 38. The systems differ with respect to the:

- Time/current characteristic
- Rated voltage
- Rated breaking capacity
- Rated power dissipation of the fuse links
- Load-carrying capacity of the fuse holders

Even trained personnel find this level of complexity difficult to master, so it goes without saying that this is an impossible task for non-technicians. Despite some technical advantages of cylindrical fuse systems, they are not included in the VDE regulations for safety reasons.



Safety information: Due to the risk of confusion, cylindrical fuses in Germany must be handled by trained persons only.

Of course, all standardized fuse systems are considered safe and permissible when they are chosen in line with their intended use and operated in accordance with local regulations.

Class CC fuses are designed for “branch circuit protection” in accordance with the North American standards UL 248-4 and CSA 22.2. Like IEC fuses (Table 3.9), they are cylindrical and have the dimensions 10 x 38 (13/32” x 1 1/2”). Thanks to their very high rated breaking capacity of 200 kA with 600 V a.c. and rated currents of up to 30 A, they are ideal for protecting relatively small branch circuits in high-power infeeds. To distinguish them visually from the cylindrical fuses, class CC fuse links have a small-diameter rejection tip on the contact cap (Fig. 3.4.2). Suitable class CC fuse holders exclude the risk of confusion with similar fuse links with lower ratings. Other cylindrical fuses with the dimensions 10 x 38 (e.g. the North American. Midget fuses with lower rated voltages and a breaking capacity of just 10 kA) cannot be used in class CC fuse holders. To distinguish them from non-current-limiting fuses, class CC fuse links are labeled “Current-Limiting”.



Fig. 3.4.2 – Class CC fuse system

Siemens class CC fuses are available with three different characteristics depending on their areas of application:

- Slow-acting characteristic designed to protect control transformers, reactors, and inductors. These fuses exhibit a much greater switching delay than the minimum delay of 12 s at 2 I_N required by the UL standard.
- Fast-acting characteristic
Designed for a wide range of applications to protect lighting installations, heaters, and controllers.
- Slow-acting, current-limiting characteristic
Designed to protect electrical motor circuits; with super-fast-acting, strong current-limiting tripping in the short-circuit range and a slow-acting response in the event of an overload.

Siemens class CC fuse holders (Fig. 3.4.2) have a state-of-the-art, shock-hazard-protected design for rail mounting with a mounting width of 18 mm (1 MW).



Safety information: During continuous operation, class CC fuse holders can only be loaded up to 80% of their rated current. The full rated current of 30 A is permitted for a short time only.

3.5 SITOR Semiconductor Fuses

SITOR semiconductor fuses have been used for many decades now to provide effective protection for converter equipment (converters, rectifiers, UPS systems, etc.) against short-circuits and to protect the supply cables against overload. The power semiconductors used in these devices (diodes, thyristors, GTOs, etc.) have a low thermal capacity, which means that they require ultra-high-speed protective devices. SITOR fuse links exhibit super-fast-acting characteristics specially developed for semiconductor protection.

This involved adjusting the characteristic of the metal fuse element in line with the thermal load-carrying capacity of the semiconductor. Due to the low thermal capacity and the strict upper limit of the junction temperature of approx. 125 °C, semiconductors possess hardly any thermal reserves between the operating temperature and the limit temperature, which is why an effective protection device must be able to trip overcurrents extremely quickly. Super-fast-acting SITOR fuses with extremely small limiter cross-sections were developed specially for this purpose (Fig. 3.5.1). Even with the operational current, these limiters can be extremely hot, which means that the melting temperature is reached very quickly when overcurrents are present. The only fuse element material that can withstand the high operating temperatures of the limiter is oxidation-resistant fine silver with a melting temperature of 960 °C. Accordingly, the fuse body is made mainly of thermally-stable aluminum oxide ceramic. To compensate for changes in length caused by highly cyclic current loads (varying load), the fuse elements are either corrugated between the limiter rows or the surface between the contacts is undulated. SITOR fuses exhibit a high varying load factor, that is, even when the load is constantly changing, the operational reliability and plant availability are not unreasonably compromised by the premature fatigue of the fuse elements.



Fig. 3.5.1 – Fuse element of a semiconductor fuse

When developing SITOR fuses, the Siemens development engineers had to resolve a number of complex optimization issues in order to fulfill the sometimes contradictory requirements:

- Super-fast-acting characteristic with low power dissipation.
The super-fast-acting characteristic requires a high temperature difference between the limiters and the external connections. This is achieved by means of extreme, localized cross-section constriction of the fuse elements and by ensuring that the heat is dissipated effectively to the connections and ceramic body. Axial heat dissipation is achieved by means of heat conduction via the connected conductors, while radial heat dissipation occurs via the ceramic body by means of convection into the surrounding atmosphere. Axial heat dissipation is optimized by means of screw contacts. Special designs with slotted blade contacts, with internal threads in the cover plates or with screw-type brackets for direct installation on air or water-cooled busbars, are available for this purpose (Fig. 3.5.3). To optimize radial heat dissipation, a large number of thin fuse elements are combined to create a cylindrical "fuse element basket". This helps achieve the largest possible fuse element surface (Fig. 3.5.2). The thermal resistance can be reduced and radial heat dissipation further optimized by hardening the sand filling with inorganic binders.
- Low tripping integral with low switching voltage
High switching voltages are required to ensure the rapid interruption of residual currents with a low let-through integral. Semiconductors are sensitive to overvoltage, however, although this problem could be resolved in SITOR fuses by carefully selecting the fuse filler and optimizing the arrangement of the limiters.

All of these requirements can be fulfilled particularly effectively with back-up fuses with operational class aR. aR fuses interrupt all currents that cause them to melt within 30 s up to their rated breaking current. Any overcurrents up to 3.5 x the rated current of the aR fuse link must be interrupted or limited by means of additional protection devices. SITOR full-range fuses with operational class gR can also be used for overload protection.

Note: Semiconductor fuses exhibit a much higher level of power dissipation than other fuse systems, which must be taken into account when they are assigned to standardized fuse bases and fuse holders. In addition to the larger conductor connections, upper limits for the maximum operational current (reduction factors) must also generally be taken into account.



Fig. 3.5.2 – SITOR fuse element basket

SITOR fuses do not constitute a fuse system as defined by the relevant standard, that is, the shape of the fuse links and contacts is not designed in accordance with standardized design principles. What they have in common is their super-fast-acting tripping behavior for protecting power semiconductors. SITOR fuse links are available in nearly all of the designs for the fuse systems described above (Fig. 3.5.3)¹⁶⁾. To install and contact the semiconductor fuses, which are not mounted directly on busbars, the components installed in the systems mentioned above (LV HRC fuse bases and switching devices, fuse mounts, fuse holders) are used. The rated values of these devices, however, are the same as the maximum values for gG and aM fuses rather than those for semiconductor fuses. This is why choosing the right components to ensure safe operation and reliable protection is no easy task and requires great care.



Fig. 3.5.3 – SITOR fuse designs

SITOR fuses comply with IEC 60269-4. The appropriate fuse bases and switch disconnectors comply with IEC 60269-2 and IEC 60947-3. The rated values of the SITOR fuses are sometimes much higher than the maximum values for which the fuse bases and switch disconnectors are rated. The following rated values are exceeded:

- Rated current
- Rated voltage
- Rated power dissipation

Siemens will be happy to provide operators of SITOR semiconductor fuses with detailed lists and information about suitable device configurations. Only these approved configurations should be used when converter installations are planned.



Safety information: When assigning SITOR fuse links to fuse bases, fuse mounts, fuse holders, or fuse switch disconnectors, you must observe the information provided in the SITOR configuration documents.

Even when SITOR fuse links are assigned to fuse bases or fuse switch disconnectors in the proper manner, this can still result in configurations that appear to be illogical or in contradiction to common practice because the usual assignment of gG fuses according to size or rated values is often not observed:

- SITOR size 2 LV HRC fuse links can be assigned to size 3 fuse bases or SENTRON fuse switch disconnectors.
- SITOR LV HRC fuse links with slotted blade contacts which, in accordance with the relevant standard, are designed for screw connection, can also be used in LV HRC fuse bases and SENTRON LV HRC fuse switch disconnectors.



Safety information: When SITOR fuse links with slotted blade contacts are used in SENTRON switch disconnectors, these devices must not be allowed to reach their rated breaking capacity. Occasional switching up to the rated current of the fuse links is permissible.

- The rated values of the SITOR fuse links apply, even if the current and/or rated voltage values of the fuse bases are lower.
- To improve heat dissipation, SITOR fuses generally require larger cable cross-sections than gG fuses. Reduction factors may also have to be taken into account for continuous and varying load applications.
- In safety switching devices, SITOR full-range fuses with operational class gR cannot generally be used for overload protection purposes with rated currents of > 63 A (with the exception of "double safety fuses" with operational class gS).

SITOR cylindrical fuse holders can also be used as fuse switch disconnectors or fuse disconnectors to IEC 60947-3 (note the relevant technical specifications). Sizes 14 x 51 and 22 x 58 can be equipped with a striker to actuate an alarm switch in the fuse holder (Fig. 3.5.4).

SITOR semiconductor fuses and the associated fuse holders and switch disconnectors comply not only with the international IEC standards but also, to a large extent, the North American standards UL and CSA, which means that machines and plants with SITOR fuses can be used virtually anywhere in the world.



Fig. 3.5.4 – SITOR fuse with striker and alarm switch

3.6 MINIZED and SENTRON Load Switch Fuse Units

Branch circuits in an electrical circuit generally require special switching and protective equipment. To save space and cut costs, therefore, special devices combining switching and protective functions in a single unit were developed. Originally conceived in the early days of fuse development, these units are technically defined as manual switching devices and are specified in the switching device standards IEC 60947-3 and VDE 0660-107 "Schalter-Sicherungs-Einheiten" (switches, disconnectors, switch-disconnectors and fuse-combination units).

Although they have the same electrical function, fuse combination units differ with respect to how they are operated:

- **Dependent manual operation:** the response time and actuating force depend entirely on the operator.

- **Independent manual operation:** the operator provides the initial energy for an energy store (spring), but the switching operation itself continues without the influence of the operator.

A differentiation is also made between the following:

- Switch disconnectors with fuses whereby the fuse is connected in series with the circuit breaker
- Fuse switch disconnectors whereby the fuse link is moved as a contact piece

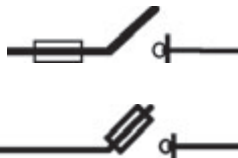

Switch disconnectors with fuses are used if the fuse system is not equipped with contacts suitable for switching or if the system is designed to be actuated by non-technicians. In this case, a circuit breaker interrupts the operational current by means of independent manual operation. The fuses are connected in series with the circuit breaker and are only accessible in a load-free or fully de-energized state.

Typical versions in this device class are shown in Fig. 3.6.1.

The switch disconnector with D0 fuses (D0 circuit breakers) is very popular in Germany. It was developed some 30 years ago for meters in residential buildings and standardized in VDE 0638 (see MINIZED switch disconnectors). Switch disconnectors with LV HRC fuses are used as main circuit breakers in functional buildings and as load transfer switches for emergency power supplies and secondary infeeds (see SENTRON switch disconnectors).

In-line switch disconnectors with LV HRC fuses are used in power distribution networks for large function buildings (see SENTRON in-line switch disconnectors).

LV HRC fuse switch disconnectors LV HRC fuse switch disconnectors are mainly used in countries with LV HRC fuse protection systems. With their solid blade contacts, LV HRC fuse links are ideal for use as moving switching contacts for occasional switching purposes and can be used to produce extremely cost-effective switching and protective devices. In the early days (that is, before the current LV HRC fuse handles were standardized), the fuse link carriers hinged onto the fuse base were originally designed simply as “three-pole fuse handles” that were always accessible and were designed to prevent the use of potentially dangerous and unsuitable tools, such as combination pliers, to replace fuses. These devices were particularly ideal for disconnecting electric circuits, which is why the term “disconnecter” came to be used for the design comprising three adjacent fuses. In the next development phase, the introduction of interrupter chambers to extinguish arcs helped achieve load switching properties and increase operator safety. The term “LV HRC disconnecter”, however, generally continued to be applied to these devices too. With the three-pole version, “LV HRC disconnectors” are available with



Fig. 3.6.1 – Switch disconnectors with fuses (image not true to scale)



Fig. 3.6.2 – SENTRON LV HRC fuse switch disconnectors (image not true to scale)

adjacent fuses and “LV HRC switching strips” with stacked fuses for direct mounting on busbars (Fig. 3.6.2). To distinguish between the two designs, the following terms will be used:

- “LV HRC fuse switch disconnectors” for devices with horizontal (adjacent) fuse links, and
- “LV HRC in-line fuse switch disconnectors” for devices with vertical (longitudinal) fuse links.

In the context of the switching device standard, both devices are “LV HRC fuse switch disconnectors” because the standard does not make a distinction between the designs relevant for operators. The following overview aims to make it easier to understand how Siemens switching devices are assigned to the standard categories:

Standard designation

Siemens device designation

Fuse switch disconnectors

- Disconnector design: • SENTRON LV HRC fuse switch disconnectors
• MINIZED fuse switch disconnectors D01

- In-line design: • SENTRON LV HRC in-line fuse switch disconnectors

Switch disconnector with fuses

- Disconnector design: • SENTRON switch disconnectors with LV HRC fuses
• MINIZED switch disconnectors

- In-line design: • SENTRON in-line switch disconnectors with LV HRC fuses
• NEOZED bar-mounting switch disconnectors D02

The switching device standards IEC 60947-3 and VDE 0660-107 together define three different device types and three different switching functions. To make it easier to distinguish between them, the devices are indicated with switching symbols (see Table 3.10).

In addition to the switching function, the **utilization category** is specified on the devices. This governs the application (Table 3.11).

Note: The utilization category of a switching device always relates to the value pair comprising the rated operational current I_e and the rated operational voltage U_e . Depending on the application conditions, therefore, the same device may be assigned more than one utilization category.

Utilization category “B” applies to fuse switch disconnectors and devices that are switched only occasionally (e.g. to disconnect circuits when maintenance needs to be carried out)

Utilization category “A” applies to devices designed to perform switching activities under normal operating conditions with the switching frequency shown in Table 3.12.

Note 1: Utilization category AC-23 includes occasional switching of individual motors, but not the routine startup, acceleration and/or shutdown of individual motors. Separate utilization categories are defined for these devices.













Device (example)	Function		
	Switch on/off	Disconnect	Switch on/off and disconnect
	Load switch 	Disconnect 	Switch disconnect 
	Load switch with fuses 	Disconnect with fuses 	Switch disconnect with fuses 
	Fuse switch 	Fuse disconnect 	Fuse switch disconnect 

Table 3.10 – Labeling of fuse combination units to IEC 60947-3

Note 2: Devices that do not exhibit load switching properties (utilization categories AC-20A, AC-20B, DC-20A, and DC-20B) must be labeled with "Do not actuate under load" or they must be sealable. Their operating characteristics are only checked with zero current.

Category A Frequent actuation	Category B Occasional actuation	Typical applications
AC-20A DC-20A	AC 20 B DC 20 B	Make / break with zero load
AC-21A DC-21A	AC 21 B DC 21 B	Switching of ohmic load including low overload
AC-22A	AC 22 B	Switching of low inductive load ($\cos > 0.65$) including low overload
AC-23A	AC 23 B	Switching of high inductive load (e.g. motors ($\cos > 0.35$))
DC-22A	DC 22 B	Switching of low inductive load ($L/R < 2.5$ ms) including low overload
DC-23A	DC 23 B	Switching of high inductive load (e.g. series motors ($L/R < 15$ ms))

Table 3.11 – Utilization categories of fuse combination units to IEC 60947-3

Rated current I_e / A	Switching cycles: category A		Switching cycles: category B	
	Total	No. of load switching cycles	Total	No. of load switching cycles
Up to 100	10,000	1,500	2,000	300
100 to 315	8,000	1,000	1,600	200
316 to 630	5,000	1,000	1,000	200
631 to 2,500	3,000	500	600	100
Over 2,500	2,000	500	400	100

Table 3.12 – Switching frequencies by utilization category

The switching of capacitors and filament lamps is not stipulated in switching device standard VDE 0660-107 and must be agreed upon between the manufacturer and operator.

Note: All fuse combination units also exhibit a short-circuit making capacity which, within its limits, prevents unintentional fault throwing, which can be dangerous to both the operator and the plant.

The short-circuit making/breaking capacity of fuse combination units is specified as a “rated conditional short-circuit current”. This comprises the short-circuit strength (when the device is switched on) and the short-circuit making capacity when protection is provided by means of fuses. For this reason, the values must always be considered in conjunction with the let-through characteristic of the fuses used. The rated conditional short-circuit current of MINIZED switch disconnectors is 50 kV a.c. when NEOZED fuse links are used, while the rated conditional short-circuit current of SENTRON switch disconnectors can be as high as 100 kV a.c. with LV HRC fuse links (depending on the type of fuse link used).

Note: With alternating current, the rated conditional short-circuit current specifies the prospective, RMS value. With other switching devices, the rated short-circuit making capacity I_{cm} is specified as the highest peak value of the prospective current. A rated value of 50 kA for a fuse combination unit, therefore, equates to more than double the short-circuit making capacity of a circuit breaker with the same rated value.

MINIZED switch disconnectors with fuses (D0 circuit breakers) are part of the family of NEOZED fuses. They have the same design as a modular installation device with a mounting width of 1.5 MW for each pole and can also be mounted on busbar systems by means of adapters (see section 3.3). A more cost-effective alternative, however, is the direct installation of the three-pole NEOZED bus-mounting switch disconnector D02 with an in-line design. This device, which has a mounting width of 27 mm, is equipped with three stacked fuses and is designed for busbar systems with a center-to-center distance of 60 mm (e.g. Siemens SR60; (Figs. 3.3.4 and 3.6.4)).

MINIZED load switches fulfill the requirements for disconnecting devices for customer plants in accordance with the Technical Connection Conditions for low-voltage networks for network operators in Germany.



Fig. 3.6.3 – MINIZED switch disconnectors D02 with busbars

MINIZED load switches currently have a wide range of applications in switchgear and controller manufacturing.

In the context of IEC 60947-3, MINIZED switch disconnectors are classified as fuse combination units with independent manual operation or "switch disconnectors with fuses"¹⁷⁾. Since they fall under utilization category "B", they are suitable for occasional switching (see Table 3.11). MINIZED switch disconnectors also comply with the German standard VDE 0638 and carry the VDE mark of conformity. All rated values relate to NEOZED fuse links for cable and wire protection (operational class gG).

In MINIZED switch disconnectors, the NEOZED fuse links are located in captive withdrawable parts, which are mechanically locked with the switch mechanism. The load switch mechanism with the storage spring is connected in series (electrically) with the NEOZED fuses and, when the device is switched off, disconnects all exposed parts from the power supply (Fig. 3.6.3).

The fuse can only be changed when the device has been made safe (i.e. it has been switched off and is no longer carrying any current or voltage). The device cannot be switched on again until the NEOZED fuse links have been inserted properly into the withdrawable unit and sufficient contacting has been established.

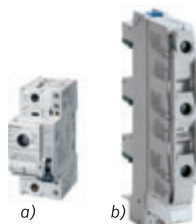
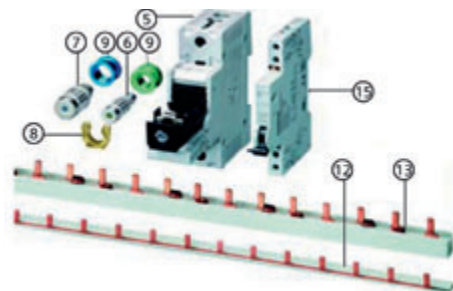

Fig. 3.6.4 –
a) MINIZED switch disconnectors D02 with auxiliary switch for remotely monitoring the switch position
b) NEOZED bar-mounting switch disconnector D02



- 5 MINIZED switch disconnectors D02 draw-out design
- 6 NEOZED fuse link, size D01
- 7 NEOZED fuse link, size D02
- 8 Reducer for fuse links, size D01
- 9 NEOZED adapter sleeves, sizes D01 and D02
- 12 Busbar, 1-pole, 1.5 MW
- 13 Busbar, 3-pole, 1.5 MW
- 15 auxiliary switches
- 15 Hilfsstromschalter

Fig. 3.6.5 – MINIZED switch disconnector system D02

These switching devices maximize shock-hazard protection and operational safety for non-technicians too, which is why they are used not only in switchgear and controller manufacturing, but also in domestic electrical installations, particularly in the precounter sector.

Note: Three-pole MINIZED D02 switch disconnectors comply with VDE 0638 and fulfill the requirements for disconnecting devices and selective overcurrent protection devices in the wiring space in the lower part of the meter panel for customer installations in accordance with the Technical Connection Conditions for low-voltage networks for network operators in Germany.

Accessories, including auxiliary switches for remote monitoring and reducers for adapting D01 fuse links, ensure that the MINIZED switch disconnector D02 can be used in a wide range of applications (Fig. 3.6.5).

¹⁷⁾ In the context of IEC 60947-3, the NEOZED fuse disconnectors with utilization category AC 20 B (mentioned in section 3.1) also belong to this device family, although they do not have any load switching capacity and are subject to dependent manual operation..

SENTRON LV HRC load switch fuse units for power distribution

The SENTRON product family encompasses switching and protective devices for low-voltage power distribution ranging from simple, tried-and-tested switch disconnectors through to intelligent, communication-capable switching device solutions. As part of the Totally Integrated Power (TIP) product platform, the emphasis is on ensuring that switching devices with and without fuses are properly coordinated. The SENTRON product range always offers the most cost-effective technical solution.

SENTRON LV HRC load switch fuse units, which are available in a wide range of different designs, perform the following key functions in a rated current range of up to 1250 A:

- Protection against overload and short circuits
- Disconnecting and switching under load

The SENTRON LV HRC product range (Fig. 3.6.6) comprises basic designs based on the arrangement of the three phase fuses and two types of operation. This results in four device types with different properties:

SENTRON LV HRC fuse switch disconnectors

Key features:

- Cost-effective protection and disconnecting device
- Dependent manual operation
- For occasional switching by authorized personnel
- For busbar infeeds and device branch circuits up to 630 A and 690 V

Note: SENTRON LV HRC fuse switch disconnectors with dependent manual operation must be switched off and on quickly to ensure that they function as required. They are shock-hazard protected (to BGV A3) and can be operated without protective clothing/equipment. As specified by their utilization category, they are only suitable for occasional switching.

LV HRC fuse switch disconnectors are designed for occasional switching/disconnection of load branches. When protected against overload and short-circuits by means of fuses, they can be switched safely even while under load.

SENTRON LV HRC fuse switch disconnectors offer a high level of shock-hazard protection and protection against the effects of arcing. They are also the most cost-effective type of LV HRC fuse switch disconnector. The disconnector design is ideal for individual applications in installation distribution boards (ALPHA, SIKUS), meter cabinets (ALPHA, ZS-400), and insulation-enclosed distribution boards (8HP). They protect downstream electric load circuits, safely disconnecting all poles from the power supply under load:

- Busbar systems (Fig. 3.3.4)
- Reactive-power compensation systems
- Electrical motor circuits (in conjunction with other protective devices)
- Frequency converters and soft-starters (in conjunction with SITOR fuse links)



Fig. 3.6.6 – SENTRON LV HRC-fuse combination units

SENTRON LV HRC fuse switch disconnectors are available with one to four poles as a mounting device for installation on level surfaces and as a three-pole bus-mounting switch disconnector for direct contacting on busbars with a center-to-center distance of 40 mm and 60 mm. Size 000 and 00 devices can also be snapped onto 35 mm mounting rails.

The standard series (sizes 000 to 3) covers most applications, from power distribution in residential/functional buildings and flexible distribution stations, to power distribution in large-scale industrial plants.

A highly robust product series with locating springs on the side of the base is available for industrial plants and distribution boards with stringent technical requirements for switching capacity, material strength, user friendliness regarding fuse monitoring, as well as operator and plant safety. Once the tactile-touch button has been pressed, the devices initiate a “quick make operation”, which is independent of the actuation speed of the operator (Fig. 3.6.7). They are often deployed in the mining, steel, or chemical industry. Versions equipped with tin-coated contact components are used in more corrosive atmospheres (e.g. with a high sulfur content).

SENTRON switch disconnectors with LV HRC fuses

Key features:

- Can be operated by non-technicians
- Independent manual operation
- Suitable for frequent (functional) switching
- Motor switching capacity

SENTRON switch disconnectors with LV HRC fuses can also be safely used by non-technicians, which is why they are installed in easily-accessible areas in distribution boards for residential, functional, and industrial buildings. They are usually installed in enclosures or cabinets on which only the rotary handle can be accessed from the outside (Fig. 3.6.8).

As such, they are ideal for use as main circuit breakers and EMERGENCY OFF switches for switchgear, distribution boards, as well as power supply and motor feeders.

In conjunction with SITOR semiconductor fuses, they can also be used in UPS systems, frequency converters, and capacitor control systems.

In countries where the power supply is not always stable, these devices are often used as CO contacts between two power supplies (supply system and emergency generating set). Four-pole devices are particularly useful for connecting distributed, alternative power generation systems (secondary infeeds) to the supply system.

The spring-operated mechanisms in the SENTRON switch disconnectors with LV HRC fuses are designed for frequent switching in accordance with the requirements of IEC 60947-3. For this reason, these devices fall under utilization category “A” for the frequent (functional) switching of high inductive loads as well as occasional switching of individual motors (AC-23A). In DC applications, two or three conducting paths in a device are connected in series to enable higher rated operational voltages (refer to the instruction manual for the devices).



Fig. 3.6.7 – SENTRON LV HRC fuse switch disconnectors with “quick make operation”



Fig. 3.6.8 – SENTRON switch disconnectors with LV HRC fuses

SENTRON LV HRC in-line fuse switch disconnectors

Key features:

- Fixed mounting on busbars
- Cost-effective, compact distribution board design
- Dependent manual operation
- For occasional switching by authorized personnel
- For outgoing cables up to 630 A and 690 V

SENTRON LV HRC in-line fuse switch disconnectors are mainly used:

- In power stations and industrial buildings providing overload and short-circuit protection for switchgear
- In substations, transformer substations, and cable distribution cabinets
- In distribution centers in commercial buildings in-line fuse switch disconnectors
- In outgoing cables and distribution boards
- In distribution boards for construction sites
- As an infeed for busbar systems

LV HRC fuse switch disconnectors combine load switching and disconnecting in a single device and, thanks to the integrated LV HRC fuses, offer full protection against overload and short-circuits.

Modular distribution configurations are made possible by the popular mounting widths 50 mm for LV HRC 00 and 100 mm for LV HRC 1 to LV HRC 3. LV HRC in-line fuse switch disconnectors allow extremely compact, clearly-structured, and cost-effective low-voltage distribution boards to be designed (Fig. 3.6.11).

SENTRON LV HRC in-line fuse switch disconnectors are usually screwed onto horizontal busbars in a vertical mounting position. Dependent manual operation must be carried out quickly, which means that it must only be performed by trained personnel with the required expertise. With the three-pole switchable design, the actuating force is reduced by means of leverage.

SENTRON plug-in in-line switch disconnectors with LV HRC fuses

Key features:

- Independent manual operation
- Can be operated by non-technicians
- For occasional actuation
- Plug-in contact on busbars
- Modular slide-in design
- High packing density

SENTRON plug-in in-line switch disconnectors with fuses are ideal if a large number of power distribution cable outlets need to be accommodated in a very limited space in low-voltage distribution boards (Fig. 3.6.10). The devices differ from the in-line fuse switch disconnectors mainly with respect to the integrated switch mechanism with stored-energy spring mechanism.



Fig. 3.6.9 – SENTRON LV HRC



Fig. 3.6.10 – SENTRON plug-in in-line switch disconnectors with LV HRC fuses

Note: Unlike SENTRON switch disconnectors with fuses, SENTRON in-line switch disconnectors with fuses cannot be used for functional (frequent) switching.

Plug-in in-line switch disconnectors with fuses are ideal for:

- Cable distribution boards and switching cabinets with vertical busbar systems positioned on edge
- Overload and short-circuit protection for downstream system components and loads
- Safely disconnecting downstream system components and loads – the switching operation takes place inside the strip itself, regardless of the actuation speed

The devices are usually positioned horizontally with a slide-in installation system on vertical busbars, which optimizes the use of space more effectively than LV HRC in-line fuse switch disconnectors installed vertically. They can be switched by non-technicians. Monitoring equipment can also be integrated if required.

Thanks to the modular design and the plug-in connections to the busbars, individual strips can be safely replaced without the need to disconnect the busbars. Due to the dense packing of the devices and the restricted vertical air flow, however, steps must be taken to ensure that critical components do not overheat (see section 5.9).

The following factors in particular must be taken into account when the switchgear panels are populated:

- Rated load factors to IEC 60439-1 depending on the number of circuits (Table 5.)
- Thermal rated current of the devices $I_{the} = 0.8 \times I_N$ of the fuse links (deviations may occur in operational classes other than gG, taking into account the configuration rules)
- The devices are arranged on the panel by size (large devices at the bottom, smaller ones at the top)
- Required ventilation space between the devices

SENTRON in-line switch disconnectors in SIVACON switchgear panels

LV HRC in-line fuse bases were developed in the middle of the 20th century as three-pole units for direct busbar contacting. Since then, they have made a significant impact on the design of distribution boards (Fig. 3.6.11). In-line distribution board sizes 00 to 3 were standardized for a busbar center-to-center distance of 185 mm. Size 00 is also available for a busbar center-to-center distance of 100 mm. In the 1970s, the design was enhanced to create LV HRC in-line fuse switch disconnectors. Open LV HRC in-line fuse bases (in-line distribution boards) are still used even today in public power distribution networks not only for cost reasons, but also due to the high level of professional expertise available. They are, however, being gradually replaced by one-pole, switchable LV HRC in-line fuse switch disconnectors. In industrial switchgear and distribution boards, three-pole switchable devices currently dominate the market for LV HRC in-line fuse switch disconnectors or in-line switch disconnectors with LV HRC fuses (Fig. 3.6.12).



Fig. 3.6.11 – LV HRC distribution boards with SENTRON in-line switch disconnectors. Left: LV HRC in-line fuse switch disconnectors. Right: in-line switch disconnectors with LV HR fuses

In-line switch disconnectors optimize the use of space on busbars, which is why they are used on large distribution boards with numerous outgoing load sections (Fig. 3.6.11.). Thanks to the modular in-line systems, switchgear and distribution boards benefit from the flexibility of the LV HRC fuse systems. Since fuse links of different rated currents and operational classes are largely interchangeable, this allows for a wide range of applications while maintaining a logical basic structure of the switchgear. Even existing systems can be easily adapted in line with different loads by installing the right fuse. A wide range of different fuse links is available in each size (Table A.3.13 in the appendix).

Note 1: Steps must be taken to ensure that the rated power consumption of the devices is not exceeded when fuses other than gG fuses are used.

Note 2: Siemens has defined detailed configuration rules regarding the arrangement of SENTRON in-line switch disconnectors on SIVACON switchgear panels. These must be observed at all times. If these rules are not observed, this can lead to localized overheating and premature, uncontrolled fuse tripping.



a
b
Fig. 3.6.12 – SENTRON LV HRC in-line switch disconnectors
a) In-line switch disconnector with fuses
b) In-line fuse switch disconnectors 3-pole, switchable

3.7 Communications-Capable Fuses

As automation continues to gain importance in a wide range of applications, requirements regarding the communications capability of switching and protective equipment (i.e. its ability to transmit, receive, and process information across large distances) in electrical systems also continue to increase. Modern SENTRON circuit breakers are intelligent devices that can exchange and process data in both directions via digital interfaces. Fuse systems are passive systems that can supply information but not process it themselves.

Thanks to a comprehensive range of accessories, Siemens fuse systems can be integrated in any state-of-the-art control and monitoring system to supply valuable additional information about the current load and load distribution. To ensure the durability of fuse systems, accessories are required that can be used for retrofitting existing fuses as part of modernization measures. Switching devices with integrated sensors that can help avoid expensive, error-prone wiring during installation should be implemented in new systems.

Fuse monitoring

As shown in Fig. 2.4, the ability to signal the operating state was a key feature even in the early days of melting fuses. Right from the outset, the indicator was an indispensable component of all high-voltage fuse systems in Germany, from household fuses to high-voltage fuses. Since the fuse can only assume two switching statuses, the indicator provides sufficient information. The only drawback is that this information must be retrieved "on site", which no longer fulfills the requirements of state-of-the-art monitoring and control systems.

The all-pole disconnection of a particular load, for example, can be initiated after a fuse has tripped. Siemens has developed a range of products (Fig. 3.7.1) and procedures to ensure that the switching status of fuses can be recorded and signaled as reliably as possible whatever the application conditions.

- The **indicator with signal detector link** is ideal for LV HRC fuse links

of sizes 000 to 4 with live grip lugs, regardless of the type of indicator. The signal detector link with striker is parallel to the fuse link and is triggered by the recovery voltage. The striker actuates a floating microswitch for remote signaling. The indicator cannot be used with rated fuse currents of ≤ 10 A because the parallel current via the signal detector link is no longer negligible in this range. In meshed networks or other applications with a low recovery voltage, signal detector links with a response voltage of 2 V are recommended.

- The **signal detector top** is ideal for fuse links of sizes 000, 00, 1, and 2. With LV HRC fuse links, it is fitted to the grip lug on the indicator side. The front indicator or combination indicator (see Fig. 3.7.1) actuates the integrated floating microswitch by means of a rocker. Although the signal detector top does not need any live grip lugs to function correctly, the machined seat must be checked to ensure that it is suitable due to the material thickness of the plastic cover plates and grip lugs.



Signal detector top
Signal detector with signal detector link
Fig. 3.7.1 – Signal detector



Safety information: This solution is not designed for safety-oriented systems; Electronic fuse monitors are recommended here instead.

Signal detectors are a simple, cost-effective solution for integrating existing, open LV HRC fuses in modern monitoring and control systems. In new buildings, however, fuse monitors or integrated fuse monitoring equipment are recommended.

- **Fuse monitors** (Fig. 3.7.2) are a reliable solution for all low-voltage fuse systems, regardless of the type of indicator or grip lugs. This universal device also functions in asymmetric networks afflicted with harmonics as well as in regenerative motors. Fuse monitors are installed on a mounting rail outside the fuse base, fuse holder, and switching device, which means they can be used in any application and are also suitable for monitoring fuses in LV HRC in-line fuse switch disconnectors.



Fig. 3.7.2 – Fuse monitor

The voltage inputs on the device are connected to the potential pick-offs upstream and downstream of the fuses via short-circuit proof cables. In this way, the fuse monitor successfully jumpers the isolating distance even if the fuse links have been removed or if the switching device is open. The internal resistance of the measuring paths is high enough to fulfill the VDE requirements regarding the touch voltage, although the upstream main switch must be switched off to disconnect the system.



Safety information: The supply cables between the voltage pick-offs and electronic fuse monitor must be short-circuit proof.

- Unlike electronic fuse monitoring, **fuse monitoring by means of SIRIUS circuit breakers** can be used for LV HRC fuse switch disconnectors with DC and AC voltage. The SIRIUS circuit breaker is fixed permanently to the handle (fuse carrier) and prewired in the factory (Fig. 3.7.3). When the device is closed, the three conducting paths of the SIRIUS circuit breaker are connected in parallel with the fuse links to be monitored. The internal resistance of the circuit breaker is high enough to ensure that the protective effect of the fuse links monitored is maintained. The circuit breaker is tripped immediately by means of the recovery voltage via the fuse links and signals the event via its auxiliary switch. When the disconnector is open, all the main current paths of the circuit breaker are also de-energized and the monitoring circuit is completely isolated (electrically) from the main circuit. The devices are easy to install because short-circuit-proof cables do not need to be laid.



Fig. 3.7.3 – Fuse monitor with SIRIUS circuit breaker

Notes: Fuse monitoring by means of SIRIUS circuit breakers is not permissible in branch circuits in which DC regeneration with a voltage > 220 V d.c. can occur in the event of a fault. When cables are laid in parallel and in meshed networks, a voltage difference of > 24 V is required on the circuit breaker for it to trip.



Fig. 3.7.4 – Electronic fuse monitor

- Like the circuit breaker, **the electronic fuse monitor** is installed on the disconnector cover and prewired in the factory (Fig. 3.7.4). The function of the electronic fuse monitor is largely the same as that of the fuse monitor. For example, it can be used in industrial networks afflicted with harmonics (for detailed technical information, see the data sheets). In addition to a group signal for remote indication, red LEDs "on site" indicate which fuse has switched, which means that fuse links that have tripped can be located and replaced more quickly.

Note: In fuse monitors with SIRIUS circuit breakers and in electronic fuse monitors, the voltages are picked off via the grip lugs on the fuse links. To ensure that the fuse monitor functions properly, therefore, the grip lugs must be live and in direct contact with the active components. Fuse standard IEC 60269 defines "de-energized" grip lugs, but not "live" grip lugs. For safety reasons, all grip lugs with inadequate insulation are defined as "live", although this is insufficient for ensuring that electronic fuse monitors function properly. To avoid malfunctions, consult the fuse manufacturer regarding the suitability of the grip lugs for voltage pick-off purposes.

Switchgear and distribution boards with LV HRC fuse switch disconnectors can be easily retrofitted with fuse monitoring equipment and integrated in state-of-the-art monitoring and control systems simply by replacing the disconnector covers.



Fig. 3.7.5 –
SENTRON LV HRC in-line
fuse switch disconnector
with integrated current
transformers

Switching position indication

SENTRON LV HRC switch disconnectors and LV HRC in-line switch disconnectors can also signal the switching position to a control center by means of integrated microswitches. In conjunction with the fuse monitor, the switching status of the device can be assessed in detail and specific measures implemented as a result.

Note: To ensure that they function correctly, microswitches that can be integrated in electronic controllers or bus systems require special (usually gold-plated) contacts with a very low contact resistance.

Current transformers

To measure and monitor electrical circuits, the busbars or cable connections can be fitted with LV HRC in-line switch disconnectors with current transformers. To save even more space, current transformers can be integrated in the strip bodies (Fig 3.7.5). This is an excellent solution for monitoring and registering load currents in individual outgoing circuits and can also be used for network analysis.

3.8 Quality and Environmental Protection

Quality you can rely on! Protective devices must function reliably if they are to perform their tasks correctly and offer the required level of protection. Unlike other technical devices, fuses do not lend themselves to functional testing, which is why responsible operators should initially pay more attention to information regarding the quality and reliability of the manufacturer than to the price list.

Due to the seemingly straightforward design of fuses, manufacturers who do not possess the required level of technical expertise consider themselves qualified enough, even to



Fig. 3.8.1 – Excerpt from the ETZ
(September 1909)

offer so-called “fuses” at bargain basement prices (Fig. 3.8.1). Considering the material and financial worth of objects to be protected as well as the responsibility of ensuring the safety of human beings, fuses are extremely cost-effective investments, which is why any attempt to compromise on safety is a questionable, not to mention extremely dangerous, venture.

Right from the outset, the success of the DIAZED system has been attributable to its superior technical properties and its reliability (see section 2). The system has been continuously optimized in close collaboration with customers to become the world-class product that it is today. Our commitment to quality is – and always has been – based on developing sophisticated technology to provide reliable protection for electrical systems in accordance with our customers’ requirements.

The quality of Siemens melting fuse systems is based on:

- Over 100 years’ experience of developing and applying fuse systems
- The careful selection and testing of materials and semi-finished parts
- High-precision manufacturing technology with monitored and extensively-automated assembly procedures (Fig. 3.8.2).

Fuse operators must be able to have confidence in the technical development expertise and manufacturing processes of the suppliers; after all, due to their very nature, melting fuses cannot be subject to functional tests prior to use. Even today, the complex physical processes that take place in the fuse during the arc phase of tripping defy useful, mathematical simulation. The experience gained in thousands of laboratory tests and millions of fuses in practice remains to this day the most reliable basis for developing and manufacturing fuses. Thanks to its sheer breadth of experience, which goes right back to the days when electrical energy was first successfully generated and harnessed, Siemens remains unrivalled in the area of fuse technology.

The products have since been continuously optimized in line with market requirements and can be integrated in state-of-the-art digital control systems. Operators rarely get to witness the fuses in action, however, since they are hidden inside the devices out of reach. To access HV HRC and D fuses, for example, the fuse links have to be practically destroyed; even LV HRC fuses cannot be accessed without causing some damage, even if this is not immediately apparent. This may cause sand to escape or other hidden damage to the melting fuses and indicator system, which can have serious consequences regarding operational safety. If an operator unscrews an LV HRC fuse link either simply out of curiosity or to perform a quality check, the fuse link must not be re-installed in the network, but must instead be thrown away or, even better, placed in the recycling bin.

Fuse operators do not need to use an X-ray device or remove a fuse to check that it functions properly; instead, various external clues can provide important information about the quality of the product and the care with which it has been manufactured, which is why, prior to deploying a fuse, operators should not be afraid to take the small amount of time and effort involved in checking it:



Fig. 3.8.2 – Sand filling for LV HRC fuse links

- **Shake test:** Fuses are not rattles! If you hear or feel any movement of sand within the fuse when you shake it slightly, the fuse is unusable. Any sand in the packaging indicates that the fuse is not sealed properly.
- **Trickle test:** Fuses are not sand glasses! If you notice any sand escaping at the indicator opening or anywhere else, the fuse is unusable.
- **Touch test:** If you feel any protruding wire ends, cover plates, or contact caps when you run your hand over the insulation body, this can indicate problems with the assembly and, in turn, the function of the device. Protruding wire ends can significantly reduce insulation, thereby increasing the risk of phase short-circuits. The blade contact must not have any sharp edges either on the top or on the bottom since they can damage the fuse base contacts during insertion and rip off the contact covers on removal.
- **Wipe test:** If the printed image is already smudged or can be easily rubbed off with a moist cloth, this indicates that the fuse has not been manufactured with the required care and attention.
- **Rust test:** Rusted or loose screws indicate that the fuse has either not been stored properly or has been already been used. In both cases, it is best not to use the fuse at all.

Although they do not look good, silver-plated contacts that are tarnished are harmless. This can occur when fuses are stored unprotected in an industrial environment or in sulfurous carton packaging.

Environmental protection

Siemens is an ecologically-responsible global business. Our stringent internal objectives also apply to fuse systems and are part of strict quality management. Even during the product development phase, the requirements regarding reliability help highlight which supporting quality-assurance measures need to be taken and any potential effects on the environment. Of course, this means that Siemens fuse systems comply with the European guidelines for the Restriction of Hazardous Substances (RoHS) and do not contain any non-approved substances.

Fuse recycling

Modern industrial enterprises must ensure that they act in an environmentally-responsible manner and minimize their use of resources. In response, Siemens has elaborated its own recycling concept in anticipation of legal requirements and has implemented this in conjunction with other fuse manufacturers in the German Electrical and Electronic Manufacturers Association (ZVEI). The system supports the voluntary recycling and re-utilization of LV HRC and HV HRC fuses that have tripped. The founding of an official organization for this purpose has resulted in a professionally-organized system for recycling almost any fuse components. Although a system was already in place for dismantling fuse bodies to recycle the contacts as scrap metal, it was not only unsatisfactory as a recycling concept, but it also had a number of other drawbacks:

- The recycling method was neither systematic nor comprehensive, which meant that only a small proportion of materials could be re-utilized.
- The melted fuse material, which was contained in the sintered body and fused in quartz, often remained undetected and, therefore, ignored.
- The process of dismantling the ceramic body was quite problematic as fumed silica or, in older products, even asbestos fibers could escape.



Fig. 3.8.3 – Environmental protection in practice

Note: Siemens was one of the first ever companies to manufacture the seals for the fuse links using asbestos-free material (SITOR fuses in 1982, and LV HRC fuses in 1985).

Nowadays in Germany, all used fuses are collected on mesh box pallets. Small quantities can be handed in at wholesalers, electricity suppliers, or other collection points (Fig. 3.8.3). For more information, visit <http://www.nh-hh-recycling.de>. The entire process is free for fuse operators.

The used fuses are taken to a copper smelter where the copper and silver content is melted down in a converter. The resulting waste is used in road and dike construction. Hazardous substances are bonded in the waste, thereby rendering them safe.

This process (Fig. 3.8.5) is a safe and cost-effective means of ensuring that nearly every fuse component can be re-circulated as raw material. Environmentally-responsible fuse operators should, therefore, note the recycling symbols printed on the fuse links on all Siemens LV HRC and HV HRC fuses (Fig. 3.8.4).



Fig. 3.8.4 – Trademarks of the association NH-HH Recycling e.V.

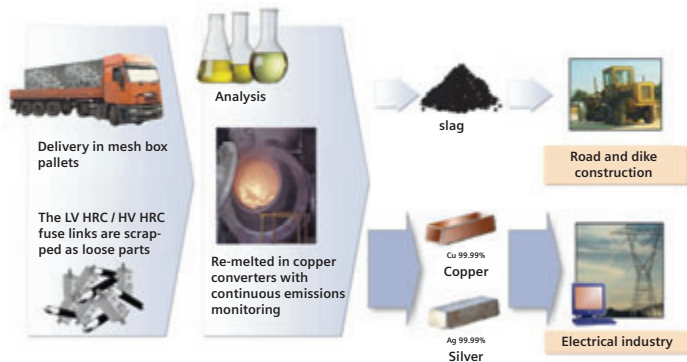

Fig. 3.8.5 – Recycling processes for LV HRC and HV HRC fuses

4 Function, Technical Specifications and Characteristic Curves

4.1 Current Interruption and Limitation

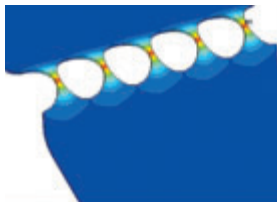

Fig. 4.1.1 – Temperature distribution in the fuse element

Fuses (or, more accurately, the limiters in the fuse element) are the “pressure-relief joints” in an electrical circuit. They heat up more quickly and intensely than any other point in the cable and, when correctly dimensioned, melt before other components can become damaged by an overcurrent. The remaining cross-section (total of all the parallel limiters) of a fuse for cable and line protection (gG fuse) is just 1 to 2% of the cross-section of the connected conductors to be protected. This value is much less for fuses designed for semiconductor protection (aR or gR fuse). It goes without saying that the equipment

required for manufacturing the limiters and the entire fuse element must demonstrate extremely high levels of precision and that the fuse element material must exhibit very strict tolerances. Temperature measurements at the limiters of the fuse element are highly complex and rarely accurate. For this reason, numerical calculations for the temperature distribution in the fuse element, which can provide a highly accurate prediction of the melting behavior particularly over short periods, are performed in the Siemens development laboratories (Fig. 4.1.1).

As soon as an impermissible overcurrent is present for long enough to melt the limiters, arcs form and the current is interrupted.

In the event of short-circuit currents (very high overcurrents), the limiters all heat up so quickly (Fig. 4.1.2) that they vaporize instantaneously. The metal vapor is forced at high pressure into the areas between the grains of sand and quickly cooled down on their surfaces, which helps limit the pressure inside the fuse. The grain size of the sand and the filling factor are crucial in determining the success of the tripping procedure: if the sand is packed too tightly (due to a high dust content), this generates excessive pressure, which can cause the fuse body to burst. If there is too much space between the grains of sand,



Fig. 4.1.2 – Short-circuit disconnection

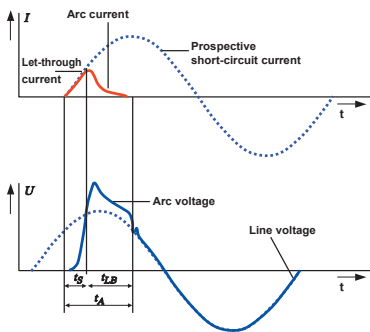

Fig. 4.1.3 – Short-circuit current limiting

t_g melting time,
 t_{LB} arcing time,
 t_A ((Ausschaltzeit))

Short-circuit currents often exhibit a very high initial peak value, the peak short-circuit current I_p (Fig. 4.3.5). Its magnetic strength increases in proportion to the square of the current value ($K \sim I_p^2$) and can exert extreme stress on the current-carrying conductors as well as their insulation and fixing components. Fuses limit the short-circuit current to its let-through current, which is normally much lower than the prospective peak short-circuit current (Fig. 4.1.3). This helps minimize not only the magnetic short-circuit forces but also the

the Arc current arc can spread to the ceramic surface or cover plates and destroy them. When the fuse is designed and manufactured properly, the sand uses its heat of fusion to cool the arc to such an extent that its peak arc voltage exceeds the rated voltage and the current is extinguished prior to the natural zero passage of a 50 Hz alternating current. The peak value of the prospective short-circuit current (without protection by means of fuses) is not reached at all (Fig. 4.1.3). The current-limiting effect t_A is the most important property of melting fuses because they can limit currents much more effectively than any other form of overcurrent protection device.

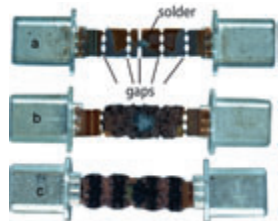

Fig. 4.1.4 – LV HRC fuse element
 a) new b) after overload tripping
 c) after short-circuit tripping

outlay involved in the mechanical design of the system. Not only the let-through current but also the let-through energy, which is expressed in I^2t values, is significantly reduced by means of current-limiting fuses. In particular, this affects the destructive energy released at the location at which an arc fault occurs. Current limitation, therefore, can be considered as a damage limitation measure, that is, it can help prevent direct and indirect damage caused by the effects of heat and minimize risk to personnel working on live components.

Note: If arc faults occur, current-limiting fuses cannot completely exclude the risk of material damage or personal injury, although they can significantly minimize the damage caused by faults such as these.

Copper fuse elements have a melting temperature of 1,080 °C, while silver fuse elements have a melting temperature of 960 °C. In their purest form, therefore, they are only suitable for tripping overcurrents where the melting temperature is reached very quickly. Overcurrents that are present for a prolonged period, whereby the melting temperature is not reached entirely or reached only very slowly, cause the fuse link to heat up to such an extent that the contacts anneal, thereby destroying adjacent plant components. Pure silver or copper fuse elements without additives to reduce the melting point, therefore, always have a “forbidden” current range in which operation is not permitted. They can only be used as back-up fuses for short-circuit protection. If smaller overcurrents cannot be excluded, back-up fuses must always be combined with additional protective equipment for this current range.

To **disconnect overloads** (relatively small overcurrents), a material with a low melting point (usually tin or a tin alloy) is applied as a solder-forming flux on the hottest part of the fuse element. This is usually located at a limiter in the middle of the fuse element (Figs. 4.1.4a and 4.1.5). As soon as this solder melts, it reacts with the fuse element material on the adjacent limiter and dissolves it. This effect is also known as the “M effect”. The M effect causes the current/time characteristic curve to shift to smaller currents in the upper setting range, thereby enabling overload currents to be tripped without inducing excessive warming (Fig. 4.1.6).

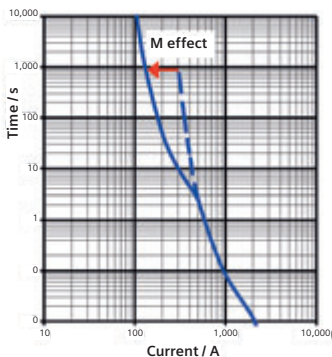

Fig. 4.1.6 – Effect of the solder on the time/current characteristic curve

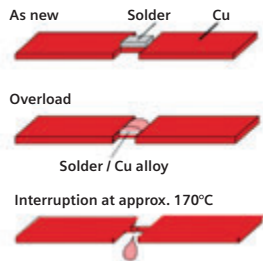

Fig. 4.1.5 – Solder reaction at overload tripping

Once the limiter has melted, an arc forms that continues to burn in both directions until it is extinguished in a periodic current zero. The melting silica sand cools the arc to such an extent that it is effectively prevented from striking again when the voltage is recovered. A non-conductive sintered body comprising the fuse element metal, solder, and quartz forms in the zone of exposure to the arc (Fig. 4.1.4 b).

When very high currents are present, all the limiters melt virtually simultaneously, which can cause a number of partial arcs (depending on the number of limiters) to form in series and the non-conductive sintered body (see above) that typically occurs in the event of short-circuit tripping to form in a uniform manner along the entire length of the fuse element (Fig. 4.1.4 c).

Using the form of this sintered body as a basis, Siemens fuse experts can accurately reconstruct the strength of the current that caused the fuse to trip. Analyzing tripped fuses can be a very useful means of determining the cause of malfunctions, although this should always be left to the experts.

The highly complex interaction between the fuse element material, limiter geometry, solder-forming flux, and the silica sand must be optimized in line with the required fuse function. Siemens development engineers have spent decades working on this very issue to create the perfectly-optimized, mature range of Siemens fuse systems that we know today.

4.2 Fuse Labeling

Information printed on fuse links

Detailed information that is not always readily understandable even for experts is printed on LV HRC fuse links. Fig. 4.2.1 shows (from top to bottom):

- Manufacturer and type designation
- Rated AC voltage (~ 400 V; future format: 400 V a.c.)
- Size (LV HRC 00) and operational class (gG)
- Rated current (100 A)
- "De-energized grip lug" symbol
- VDE mark of conformity (and any other approval symbols)
- Applicable standard (IEC 60269)
- Rated breaking capacity (120 kA)
- Country of origin (Germany)
- EU mark of conformity (CE)
- LV HRC recycling symbol
- Date/code of manufacture



Fig. 4.2.1 – LV HRC labeling



Fig. 4.2.2 – Labeling on DIAZED fuses

Certain DIAZED fuses still carry a "snail" symbol to indicate a "slow-acting" characteristic (Fig. 4.2.2).

This is only required by VDE 0635 for TNDz fuses.

Semiconductor fuses also carry the circuit symbols for a fuse and a diode (see right).



Indicators must be installed for LV HRC fuses. They can be positioned either in the middle at the front or on the end at the top. Fig. 4.2.1 shows both versions ("combination indicator"). A date code, which allows operators to determine the date of manufacture, is also normally provided.

Operational class gL has since been replaced by gG, although it can still appear printed on certain fuses. This is gradually being replaced by the internationally-standardized operational class gG (see Table 5.2).

Fuse holders (which also comprise fuse bases and fuse mounts) must include the name of the manufacturer and a type number for unique identification. Operators must note the specifications regarding the rated current for the thermal load-carrying capacity and the rated voltage for the insulation. Fuse holders are usually suitable for DC and AC voltages, which is why no distinction is made here in the designation.

Note: The power that can be absorbed by the fuse base or fuse holder is equal to the maximum power loss (rated power dissipation) of a gG fuse of the corresponding size (Tables A.4.5.2 and A.4.5.3 in the appendix). If fuse links with different operational classes are used (e.g. aR, gR, gS), reduction factors may have to be taken into account. This also applies to D fuses, which are standardized in operational class gG only, but which are also offered by Siemens for industrial applications as gR SILIZED fuses. For the correct assignment, refer to the product documentation.

Color coding

If fuses are mixed up when they are replaced, this can result in malfunctions, overheating, or even cause the switching function to fail. To help prevent confusion, therefore, the relevant standards define a color coding system to complement the data printed on the fuse. They relate to the following areas:

- Operational classes and rated voltages for LV HRC fuses
- Rated currents for screw-in fuse-links.

With LV HRC fuse links, the rated voltage of 500 V is indicated with a white background in the designated color and the rated voltages of 400 V and 690 V with a black background in a corresponding color bar; brown is used for gTr fuses and red for gB fuses (Table 4.2.1).

Alternatively, 400 V gG fuses can have blue or black bars. With DIAZED and NEOZED fuses, the indicators (Fig. 4.2.3) and adapter sleeves have the same color as the rated current of the fuse link (Table 4.2.2)

gG	aM	gTr	gB
400 V*)	400 V	400 V	
500 V	500 V		500 V
690 V	690 V		690 V
1000 V	1000 V		1000 V
*) or black			

Table 4.2.1 – Color coding for LV HRC fuses



Fig. 4.2.3 – D system indicators

I/A	2	4	6	10	13	16	20	25	35	50	63	80	100
Color	pink	brown	green	red	black	grey	blue	yellow	black	white	copper	silver	red

Table 4.2.2 – Color coding for D fuses

4.3 Characteristic Curves

Time/current characteristic curves

Time/current characteristic curves are characteristic features of fuses and help determine their application. The time/current characteristic curves should be optimized in line with the load-carrying capacity of the equipment to be protected to enable optimum loading and effectively suppress damaging overstress. Time/current characteristic curves also provide important data for coordinating fuses with each other and with other protective equipment.

In contrast to electromechanical or electronic overcurrent protection devices, fuses do not have a fixed tripping current as of which the protective effect becomes apparent. With fuses, the time that elapses until the limiters of the fuse element melt (melting time) and, in turn, the tripping action is triggered depends on the magnitude of the overcurrent. For this reason, each fuse has a characteristic melting time for each overcurrent that trips a fuse. The value pairs of currents and the associated melting times are represented in time/current characteristic curves (Fig. 4.3.1).

Note: Dotted sections of characteristic curves indicate areas in which the fuse melts but does not have any breaking capacity (back-up fuse). Overcurrents in this range are impermissible and must be avoided by means of suitable measures or disconnected by other protective elements.

To make it easier to compare the curves, the double logarithmic scales in the diagrams are internationally standardized. **Mean time/current characteristic curves** are normally used. In accordance with the standard for low-voltage fuses (IEC 60269), the deviations from these characteristic curves can be $\pm 10\%$ in the direction of the current. With Siemens fuses, these deviations have a much smaller tolerance of $\pm 5\%$, which results in additional benefits for operators (see section 4.4 "Selectivity").

Time/current characteristic curves represent virtual melting times, that is, time values that are calculated arithmetically from measured integral values (I^2t values):

$$t_{vs} = \int i^2 dt / I_{eff}^2$$

The **virtual melting time** t_{vs} is calculated by incorporating the area under the squared current curve over the melting time and then converting this integral to a rectangle of equal area with the RMS value square of the short-circuit current (Fig. 4.3.2). The melting integral $\int I^2 dt$ is determined with an oscillogram by means of short-circuit tests and then expressed as a proportion of the RMS value of the short-circuit current I_{rms} . Depending on the time characteristic of the short-circuit current, the virtual melting times may differ significantly from the real melting time (Fig. 4.3.2).

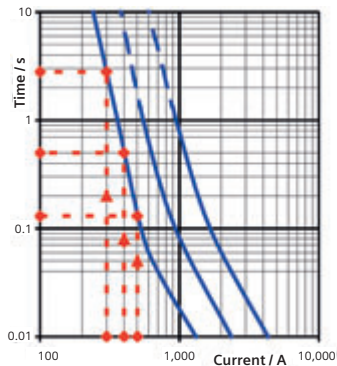

Fig. 4.3.1 – Time/current characteristic curves

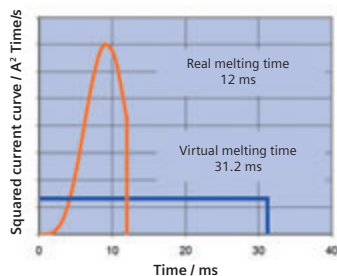

Fig. 4.3.2 – Real and virtual times

With melting times in excess of 100 ms, the difference between real and virtual times is negligible. With shorter melting times (short-circuit currents), the difference must be taken into account.

Explanation: When the virtual melting time is defined, it is assumed that the current present when a short-circuit occurs immediately jumps (square jump) to the RMS value of the short-circuit current and then continues to flow unchanged like a direct current until the limiters melt. Particularly with high peak short-circuit currents with V d.c. component (Fig. 4.3.5), the difference between the real and the virtual melting times can be naturally very large. The longer the melting times, the smaller the differences; as of 100 ms, the differences are negligible.

It is easy to see that, in the short-time range, the virtual times in fuse characteristic curves cannot be compared with the actual tripping times of mechanical -switches or the actuating times of tripping devices. The same applies to fuses in different electrical circuits (e.g. in different phases of a three-phase system) because different currents flow through these.

Note: In time ranges less than 100 ms, virtual times determined from fuse characteristic curves must not be used to coordinate fuses with switching devices. In this range, I^2t values must be used as a basis for comparison

I^2t characteristic curves

I^2t values (Joule integrals) depend on the design of the fuse and, as such, describe real **physical fuse properties**. The (actual) melting times, however, are determined on the basis of the time characteristic of the current, which is influenced to a large extent by the making angle and system impedance (see above). Virtual times calculated on the basis of time/current characteristic curves, therefore, must not be compared with the real times (e.g. tripping times of switching contacts). To coordinate fuses with other protective equipment, Siemens product documentation also contains I^2t characteristic curves (Fig. 4.3.3). These integral values equal the thermal effect of the current that trips the fuse and are, therefore, also known as "Joule integral" values. With melting times of ≤ 1 ms, the Joule integrals are constant values, which result solely from the limiter cross-section and the fuse element material.

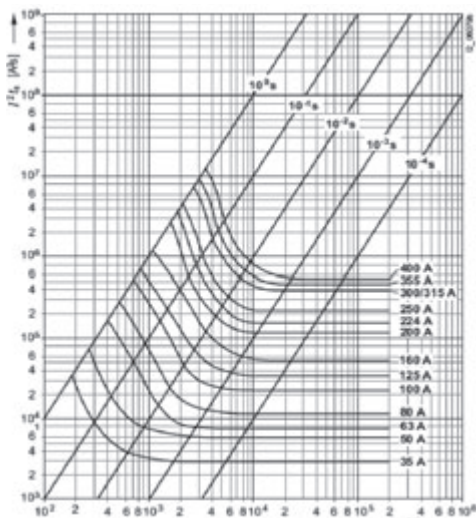

Fig. 4.3.3 – I^2t characteristic curves

Let-through characteristic curves

High short-circuit currents are restricted to much smaller values by means of fuses that limit let-through currents because the fuse interrupts the current before it reaches the initial peak value. The highest instantaneous values that a short-circuit current limited by means of fuses can reach are represented as let-through current characteristic curves and can be obtained from the fuse manufacturer (Fig. 4.3.4). Let-through characteristic curves are used to coordinate fuses with components that are sensitive to current or subject to dynamic loads, such as:

- Semiconductor components
- Relays
- Contactors
- Circuit breakers
- Busbars

The let-through current characteristic curves can be used to determine the values to which the fuse limits the prospective short-circuit current

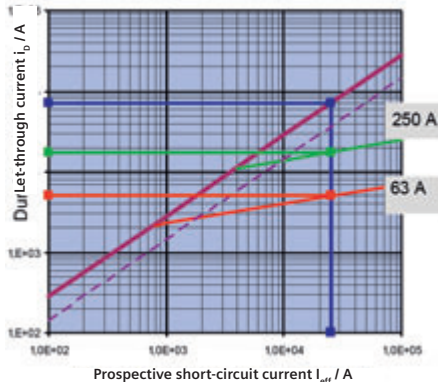

Fig. 4.3.4 – Let-through current characteristic curves

When using let-through current characteristic curves, note that

- the prospective short-circuit current determined from short-circuit calculations is read on the **horizontal axis** in the diagrams -as the **RMS value of the 50 Hz alternating current** (without the protection afforded by fuses, this prospective current would flow at the fault location)
- The **let-through current is read as an instantaneous value** on the **perpendicular axis**.

In the example shown in Fig. 4.3.4, a maximum peak short-circuit current I_p of 70 kA (upper limit) can occur when a prospective short-circuit AC current of 25 kA (RMS value) is present. A 250 A gG fuse would limit the current to its let-through value of $I_0 = 17$ kA, while a 63 A fuse would only allow 5 kA through.

Explanation: The magnitude of the peak short-circuit current I_p varies by a factor of 2 (peak factor), depending on when the short-circuit occurred (making angle) and the power factor ($\cos \varphi$) of the shorted circuit. The upper limiting line in diagram 4.3.4 equates to the maximum peak value in the outer conductor with the least favorable switching instant (zero crossing of voltage) and the purely inductive electric circuit ($\cos \varphi = 0$) with a symmetrical, three-pole short-circuit (Fig. 4.3.5). The dotted line below equates to the best-case scenario at the start of the short-circuit in the current zero and when $\cos \varphi = 1$. Without current-limiting protective equipment, a peak short-circuit current at the level of the solid line at the top must be assumed.

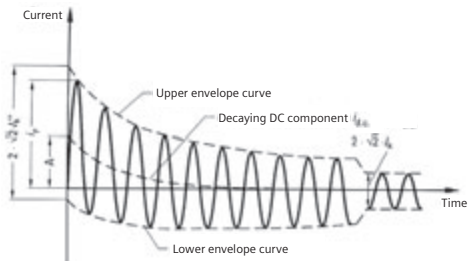

Fig. 4.3.5 – Short-circuit current characteristic in a three-phase system

4.4 Selectivity

Selectivity in protective equipment is important for ensuring a high level of supply reliability in electrical networks. Selective protection increases the availability of electric currents and minimizes damage if a fault occurs. Selective protection is easy to achieve with fuses, although selectivity is also possible in conjunction with other protective equipment (e.g. circuit breakers).

Selectivity means that only the faulty electric circuit is disconnected while all parallel electric circuits remain in operation.

This means that a fault current is only to be disconnected by the protective element that is directly assigned to the faulty branch circuit. No other protective equipment is to switch or trip and must remain intact.

There are two types of selectivity:

- **Full selectivity:** applies to all fault current strengths
- **Partial selectivity:** only applies up to one limited fault current strength.

Selectivity between different protective equipment can be determined by means of time/current characteristic curves or I^2t characteristic curves. In time ranges less than 100 ms, the I^2t values must generally be used to coordinate different protective equipment.

A number of examples are shown here to illustrate common selectivity scenarios:

Selectivity between fuses

Selectivity between fuses connected in series is achieved when the melting time of the upstream fuse is greater than the OFF time of the fuse at the fault location.

Selective protection is easy to achieve with fuses because their melting time/current characteristic curves run practically parallel to each other across the entire current range and do not overlap (Fig. 4.4.1).

The easiest way to achieve selective protection in a radial network is to use standardized gG fuses.

When the rated currents are graded with a ratio of 1 : 1.6 (two rated current steps), gG fuses with rated currents of 16 A to 1,250 A are always mutually selective across the entire fault current range. Under certain, defined conditions, Siemens gG fuses are mutually selective from one current step to another (i.e. 1 : 1.25).

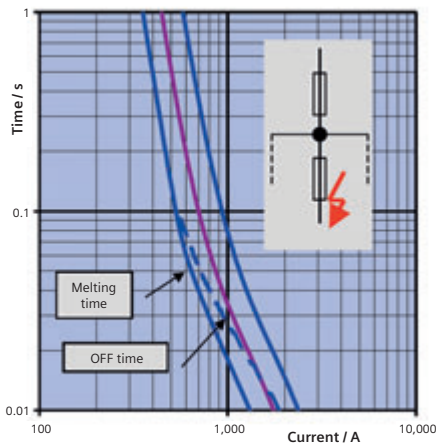

Fig. 4.4.1 – Selective protection in a radial network

With all other fuses, selectivity can be determined on the basis of the manufacturer documentation. The time/current characteristic curves can be used here for the entire current range (overload and short-circuit currents). When short-circuit tripping occurs (melting times of less than 100 ms), however, the OFF times (melting time + arcing time) of the downstream fuses and the melting times of the upstream fuses must be taken into account (Fig. 4.4.1).

In time ranges as of approximately 100 ms, the duration of the arc (arcing time) is short compared with the melting time. In this range, the melting time determined from the time/current characteristic curve almost reflects the total OFF time.

Selectivity between fuses and circuit breakers

Like fuses, circuit breakers trip after a particular length of time depending on the current. This correlation is represented in time/current characteristic curves and enables selectivity analyses with fuses (Figs. 4.4.2 and 4.4.3). In simple terms, the tripping curve of a circuit breaker comprises a vertical branch for the tripping current and a horizontal branch that corresponds to a constant tripping time. The fuse characteristic curve runs almost diagonally because it falls continuously in line with a constant melting integral even at very high currents. Depending on the relative position of the characteristic curves, interfaces that mark the selectivity limits can occur (Fig. 4.4.3).

Note: I^2t characteristic curves are recommended to coordinate fuses and circuit breakers. They must be used in the time range below 100 ms. With times in excess of 100 ms, time/current characteristic curves can also be used.

When fuses and circuit breakers are connected in series, two different arrangements are possible:

a) Circuit breaker upstream of the fuse

This arrangement (Fig. 4.4.2) is often used in low-voltage distribution centers. When the fuse and circuit breaker are properly coordinated (i.e. their characteristic curves do not overlap), selectivity is achieved across the entire current range (full selectivity). The OFF characteristic curve of the fuse must be compared with the tripping characteristic curve of the circuit breaker.

b) Fuse upstream of the circuit breaker

This arrangement (Fig. 4.4.3) is often used in domestic electrical installations. Due to the different functional principle of the protective elements, the characteristic curves always intersect. The point at which they intersect marks the limit current I_D for (partial) selectivity. If fault currents less than I_D occur, the circuit breaker interrupts the current itself before the fuse melts. When higher currents are present, the fuse responds more quickly. When the limit current is approached, both protective elements trip and the protective combination is no longer selective. This effect can be desirable, however, when the breaking capacity of the circuit breaker is not significantly greater than I_D and the fuses acts as a back-up fuse for the circuit breaker. This scenario does not involve selectivity, however.

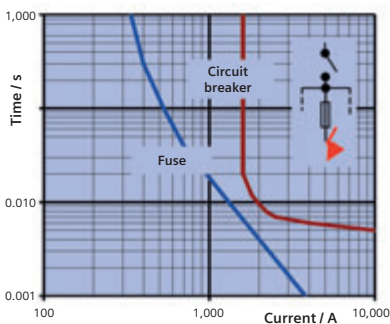

Fig. 4.4.2 – Circuit breaker upstream of the fuse

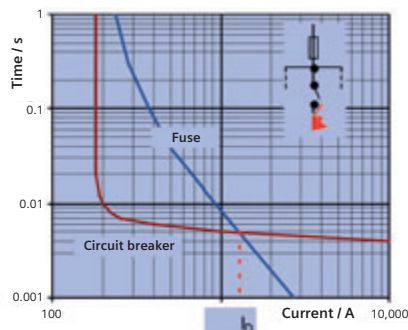

Fig. 4.4.3 – Fuse upstream of the circuit breaker

Selectivity in service equipment

In service equipment, protective devices that often feature very different fault-clearing capabilities and breaking capacities are connected in series along the length of the main line. This protective equipment must be graded in such a way that they are mutually selective. An overcurrent protection device in the precounter sector is located between the subdistribution boards with miniature circuit breakers to DIN VDE 0641 and the service boxes with LV HRC fuses to DIN VDE 0636. The overcurrent protective device is to behave selectively vis-à-vis both sets of equipment. In addition to LV HRC fuses or switch disconnectors with D0 fuses of characteristic gG, selective main miniature circuit breakers (SH circuit breakers) to E DIN VDE 0643 or E DIN VDE 0645 that interact with the miniature circuit breakers are used (Fig. 4.4.4).

If a short-circuit fault occurs downstream of the miniature circuit breaker (socket outlet short-circuit), the solution featuring LV HR Cor D0 fuses only offers partial selectivity up to fault currents of $< I_D$ (Fig. 4.4.3). The selectivity limit of B16 Siemens miniature circuit breakers vis-à-vis upstream fuses of 35 A gG is approx. 1 kA. If higher fault currents are present, the precounter fuses can also trip. The selectivity limit of most larger back-up fuses of 63 A increases to 2.4 kA, which means that the back-up fuse is unlikely to trip because socket outlet faults barely exceed 1 kA.

In this case, SH circuit breakers behave selectively up to the breaking capacity of the miniature circuit breakers. When the rated currents are graded properly, the service fuse remains intact in both cases, which is essential for maintaining the power supply for neighboring apartments.

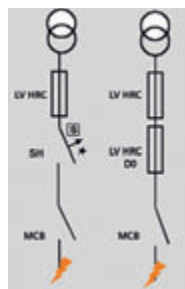

Fig. 4.4.4 – Selective protection in service box

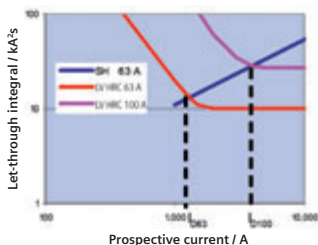

Fig. 4.4.5 – Selectivity limits

If short-circuit faults occur upstream of the sub-distribution board (riser short-circuit), the gG fuses behave selectively at a rated current grading of 1 : 1.6 up to the maximum fault currents and maintain the power supply for neighboring meter circuits (full selectivity). Due to their integral mechanical response time, SH circuit breakers are only selective in this case up to the selectivity limit I_D (partial selectivity). The selectivity limit current I_D can be determined on the basis of the I^2t characteristic curves contained in the manufacturer documentation (Fig. 4.4.5).

The protective effect in the overload range can be easily determined on the basis of the time/current characteristic curves or by comparing the tripping and non-tripping currents of the protective equipment (Table 4.4.1). While the tripping behavior of melting fuses and miniature circuit breakers is optimized in line with the load-carrying capacity of the cable, SH circuit breakers are better suited to load limitation.

Overcurrent protection device	Characteristic	Non-tripping current	Tripping current
Melting fuse	gG	$1,25 I_N$	$1,45 I_N^*$
SH circuit breaker	E	$1,05 I_N$	$1,20 I_N$
Miniature circuit breaker	B	$1,13 I_N$	$1,45 I_N$

*) Fusing current to VDE 06 36, special test for line overload protection

Table 4.4.1 – Tripping behavior

Selectivity in meshed networks (nodal point fuses)

With their multiple infeeds, meshed networks (configured as low-voltage distribution networks) offer a high degree of supply reliability. Each cable run is supplied from two sides. Due to the associated outlay and complicated protection conditions, meshed networks are increasingly operated on an open basis (i.e. as a radial network with a clearly-defined fuse hierarchy). The following descriptions only apply to fully-meshed networks.

Meshed networks normally use cables with the same cross-section and gG fuses with the same rated current at all nodal points. An overcurrent in a branch cable, therefore, is always fed via a nodal point by means of two partial currents which, depending on the impedance ratio, can be very different. Two parallel fuses are, therefore, fitted upstream of each fuse (Fig. 4.4.6).

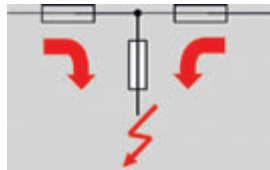

Fig. 4.4.6 – Nodes in meshed networks

The fuses at the nodal point behave selectively when the fuse that carries the total current (fault current) trips while the two fuses through which the partial currents flow remain intact. If an overcurrent is distributed evenly (50 : 50) across the two back-up fuses, the fuse in the faulty branch still trips selectively vis-à-vis the other node fuses despite having the same rated current. If the current is not distributed evenly, selectivity is only ensured up to the maximum value of the ratio between the maximum partial current and the total current ("meshed network factor"). For standard -gG fuses, a meshed network factor of 0.63 applies, that is, if none of the partial currents exceeds 63% of the total current, an overcurrent is interrupted selectively.

When Siemens LV HRC fuses are used as nodal point fuses in meshed networks, strict manufacturing tolerances yield a meshed network factor of 0.8, that is, even if a partial current reaches 80% of the fault current, the fault is still interrupted selectively.

In contrast to radial networks, individual fuses that are tripped in meshed networks as a result of temporary overload may go unnoticed because the supply is maintained via parallel branches. For this reason, the fuses must be checked at regular intervals to ensure that the high degree of supply reliability is maintained.

4.5 Power Dissipation (Power Loss)

Electrical melting fuses function according to the principle of self-heating by means of currents. Overcurrents heat defined points of the fuse element up to the melting temperature, thereby interrupting the circuit. A side effect of this functional principle is that Joulean heat is generated and dissipated even when normal operational currents are present. This intrinsic consumption of the melting fuse is popularly known as "power loss" (this term is also used in older standards). The more neutral term "power dissipation", which is used in more recent standards, has yet to gain general currency.

Note: In practice, many people think that melting fuses generate particularly large amounts of "power loss". This is most likely due to the significant rise in temperature that occurs during tripping, and the fact that skilled as well as non-skilled persons have burnt their fingers while changing a fuse without paying enough attention. These high temperatures are due, however, to the heat output of the arc and in no way indicate power dissipation and temperature rises during normal operation.

The power dissipation of fuses can be significant in quite different ways:

- Network operators, for example, consider “power loss” from an economic point of view as a cost factor incurred by consumption that is not registered by meters.
- When designing enclosures, manufacturers of switchgear and distribution boards must take into account that fuses are a source of heat.
- Fuse developers consider power dissipation to be a necessary part of the physical function of a fuse (function-related power), which must be minimized taking into account other properties.

Economic aspects

The intrinsic consumption of melting fuses contributes to the network losses in the low-voltage distribution network and is, therefore, a cost factor (loss) for the network operator. In municipal low-voltage distribution networks, the network losses equate to 4% of the transferred power or 3% of the energy, which means that they must not be ignored. Exact information regarding the extent to which fuses contribute to network losses is not available, although it can be assumed that the intrinsic consumption of a fuse equates to the consumption of between half a meter and one meter of the connected conductor. This means that fuses may cause somewhere between 5% and 10% of network losses in municipal low-voltage networks, a figure that is much lower in rural networks; in total, therefore, less than 0.5% of the transferred power.

Since accurate information is extremely difficult to obtain, the mean operating power dissipation for each fuse in networks fully protected with fuses is assumed to be 3 W. This value equates roughly to the stand-by consumption of common electronic devices (Fig. 4.5.1). The “dispensable” stand-by losses, however, must be offset against the “indispensable” function-related power of important protective elements.

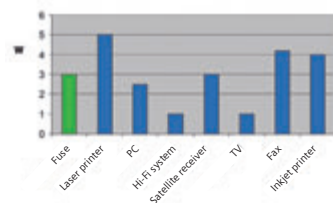

Fig. 4.5.1 – Standby consumption values for electronic devices

Note: Although the rated power dissipation is one of the characteristic values of fuse links, the power dissipated by the devices during operation is not mentioned in the low-voltage switchgear standard VDE 0660-100. As a result, this could infer that the power dissipation in electromechanical switching devices is negligible. It must always be assumed, however, that all overcurrent protective equipment with thermal tripping devices (circuit breakers, miniature circuit breakers) exhibit the same (or much higher) power dissipation as the fuses (Fig. 4.5.2)

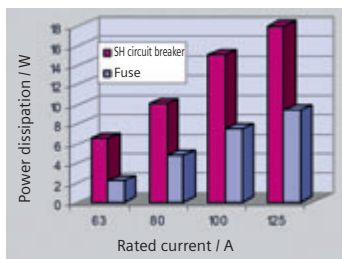

Fig. 4.5.2 – Power dissipation values

Heat source in switchgear and distribution boards

The maximum rated currents of fuse holders and maximum values for the amount of power that can be consumed (rated power consumption) are defined for each fuse size (Table 4.5.1 and Tables A.4.5.2 and A.4.5.3 in the appendix).

The rated value for the consumable power of a fuse holder (fuse base, fuse mount) equates to the power dissipation of a fuse link that can be consumed by the fuse base under normal operating conditions.

The standard values for the power that can be consumed by LV HRC fuse bases equate to the power dissipation of aM fuses and gB fuses with the highest rated current level at a rated voltage of 690 V. The values also relate to room temperature and to the cross-sections of the connected conductors as listed in Table 4.5.1. Significant deviations from these conditions can affect the amount of power that can be absorbed by fuse bases in both directions. Key influences here include:

- Material and cross-section of the connected conductors
- Operating temperatures that differ significantly from room temperature
- Limited or forced air circulation (by means of covers or fans)

For 400 V fuses with operational class gG, the LV HRC fuse bases are generously dimensioned with sufficient thermal reserves, even if overloads occur or high ambient temperatures are present (see Table A.4.5.2 in the appendix).

Note: Due to their physical nature, SITOR LV HRC fuse links or SILIZED screw-in fuse links for semiconductor protection exhibit greater power dissipation levels than other fuse types. When suitable fuse bases or fuse combination units are selected, therefore, the amount of power that they can absorb must always be taken into account. Technical planning documents contain detailed information about this.

Size	Rated current / A	Rated power consumption	Cable cross-section mm ² Cu
000	100		35
00	160	12	70
0	160	25	70
1	250	32	120
2	400	45	240
3	630	60	2x185
4	1,000	90	2x(60x5)
4a	1,250	110	2x(80x5)

Table 4.5.2 – Power that can be absorbed by LV HRC fuse bases

Minimizing power dissipation

Anyone involved with fuses should make every effort to minimize the power they dissipate. Since responsibility for this lies initially with the manufacturer, Siemens fuses significantly undershoot the standard specifications for power dissipation thanks to their highly sophisticated fuse element technology (Fig. 4.5.3).

By observing certain rules, however, plant engineers and operators can also play a significant part in minimizing power dissipation during operation:

- Use high-quality fuse links**
 The systematic use of low-loss fuse links helps minimize temperature rises and cut operating costs.
- Rated voltage no higher than required**
 Depending on certain technical factors, power dissipation increases with the rated voltage (Fig. 4.5.4). The rated voltage of the fuse links, therefore, should be as close as possible to the rated voltage, and certainly not much higher (see also section 5.1). Although a 690 V fuse can be used in a 400 V network, this can double the power dissipation. In such a case, at least of this could justifiably be considered "power loss".
- Rated current as high as possible**
 High rated currents of the fuse links minimize power dissipation during operation. A higher rated power dissipation does not necessarily mean a greater rise in temperature during operation. Exactly the opposite is the case when fuses with different rated currents are used. If the operational current of a system is the same, the fuse with the lower rated current and, in turn, the lower rated power dissipation generates the greatest losses. This apparent contradiction is illustrated in Fig. 4.5.5 using LV HRC fuses with operational class gG as an example: When the operational current is 125 A, a 100 A fuse generates more than 10 W, the 125 A fuse generates less than 8 W, while the 160 A fuse only generates 6 W.

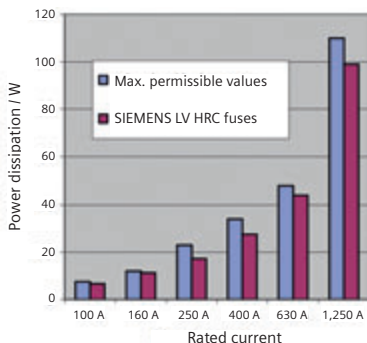

Fig. 4.5.3 – power dissipation of LV HRC fuse links

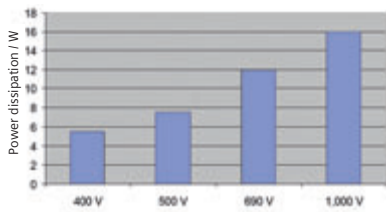

Fig. 4.5.4 – power dissipation of 100 A gG fuse links

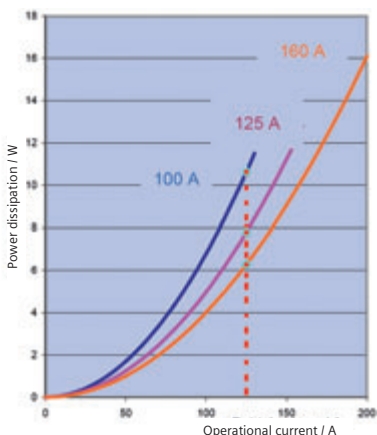

Fig. 4.5.5 – Power dissipation of gG fuses with different rated currents-

Whenever possible, therefore, fuses with higher rated currents should be preferred if problems with temperature rises are encountered.

These rules can be applied to all electrical circuits that only need to be protected against short-circuits, e.g.

- Fuses in compact enclosures
- Protecting capacitors in networks with harmonic currents
- Motor protection fuses
- When enclosures contain a number of fuses

Of course, this rule must not be applied when the fuses are directly assigned to a device (e.g. cable) not only for short-circuit protection but also for overload protection.

5 Fuse Applications

5.1 General Selection Criteria

Selecting the right fuse is based on the following criteria:

- The **data for the power supply** that is to be interrupted if a fault occurs
- The **protective task** or the equipment to be protected

The following criteria regarding the power supply must be taken into account:

- The maximum permissible rated voltage of the fuse must be greater than the maximum permissible rated voltage of the network, including the tolerance (Table 5.1).
- The fuse must be suitable for the current type and network frequency. Compatibility for direct current and alternating current is specified separately. Unless more detailed information is available, frequencies of between 45 Hz and 62 Hz are permissible.
- The breaking capacity of the fuse must be greater than the prospective short-circuit current at the installation site.

Rated voltage of the fuse	Maximum permissible rated voltage
230 V	253 V
400 V	440 V
500 V	550 V
690 V	725 V

Table 5.1 – Permissible rated voltages

Special fuses with an appropriate characteristic have been developed to protect equipment that is used on a regular basis. Characteristics for cables, electrical motor circuits, and semiconductor components have been standardized globally. In Germany, additional standards for transformer protection and protecting equipment in the mining industry apply. The fuse links are labeled with the IDs for the relevant applications and/or characteristics (Table 5.2).

The first, lower-case letter indicates the breaking range of the fuse:

- "g" indicates a full-range fuse and means that the fuse can interrupt any overcurrent, from the smallest melting current up to its rated breaking capacity. Full-range fuses can be used as standalone protective elements.
- "a" indicates a back-up fuse and means that the fuse can only interrupt high currents as of a multiple of its rated current. Back-up fuses are only suitable for short-circuit protection, which is why they are combined with other equipment for overload protection. They are often used for back-up protection for other switching devices with a lower breaking capacity (e.g. contactors or circuit breakers).

The second, upper-case letter indicates the characteristic and, in turn, the area of application (Table 5.2). Since fuses are highly durable products, operators can still come across products with labels that are not explained in current standards. For this reason, Table 5.2 also contains some descriptions that are no longer in use today.

Operational class	Application (characteristic)
IEC / VDE operational classes	
gG	Full-range fuse for general use, primarily cable and line protection
aM	Switching device back-up fuse for electrical motor circuits
gR	Full-range fuses for protecting semiconductor components (faster acting than gS)
gS	Full-range fuses for protecting semiconductor components, for increased line capacity
aR	Back-up fuse for protecting semiconductor components
VDE operational classes	
gB	Full-range fuse for equipment in the mining industry
gTr	Full-range fuse for transformer protection, rated according to apparent transformer power (kVA), not rated current (A)
Slow acting	Full-range fuse for cable and line protection
Fast acting	Full-range fuse for cable and line protection
Other operational classes	
gM	Full-range fuse for protecting electrical motor circuits with two rated currents (widespread in Great Britain)
gN	North American fuse for general use, primarily cable and line protection
gD	North American fuse with slow-acting characteristic for general use and motor protection
gl	Formerly IEC operational class (slow acting), replaced by gG
gll	Formerly IEC operational class (fast acting), replaced by gG
gL	Formerly VDE operational class, replaced by gG
gT	Formerly VDE operational class (slow acting), replaced by gG
gF	Formerly VDE operational class (fast acting), replaced by gG
gTF	Formerly VDE operational class (slow/fast acting), replaced by gB

Table 5.2 – Operational classes and applications

5.2 Cable and Line Protection

The provisions for protecting cables and lines against excessive temperature rises are defined in VDE 0100-430. This covers the most popular application of fuses, for which the operational class gG has been standardized. The time/current characteristic curves of these fuses are optimized in line with the load-carrying capacity of insulated conductors. The rated fuse current is always assigned to the load-carrying capacity of the cable in accordance with the following formula:

$$I_b \leq I_n \leq I_z \text{ with}$$

I_b = operational current of the electric circuit

I_z = continuous load-carrying capacity of the conductor (s. VDE 0100-430)

I_n = rated fuse current

Since lines can be overloaded by up to 45%, the overcurrent protection device is to trip at $1.45 I_n$. With D fuses, this condition is fulfilled at rated currents of $> 10 \text{ A}$ and, with LV HRC fuses, at rated currents of $> 16 \text{ A}$.

Note: With gG fuses, the conventional tripping current is normally $1.6 I_n$ and is, not entirely accurately, compared with the tripping current of other protective equipment (e.g. miniature circuit breakers). From a physical point of view, however, this comparison is incorrect because it is based on different testing conditions. Practical testing set-ups, which have since also been adopted in the fuse standards, show that the tripping behavior of gG fuses during overload is the same as that of miniature circuit breakers and, in turn, the overload capability of the lines to be protected.

5.3 Transformer Protection with LV HRC Fuses

The low-voltage side of distribution network transformers up to 1,000 kVA is protected with fuses against overload and busbar short-circuits. SENTRON LV HRC fuse switch disconnectors or in-line switch disconnectors, equipped with fuses of operational classes gG or gTr, are used for this purpose. The LV HRC fuses and safety switching devices are also suitable for disconnecting the transformer and low-voltage distribution network.

HV-side HV HRC fuses are responsible for protecting against internal transformer faults, including short-circuits at the low-voltage terminals. In theory, the supply cables from the transformer terminals to the low-voltage-side incoming circuit breaker are not protected, which is why they are insulated and laid with special care.

Since the transformers are rated in kVA in accordance with their apparent power, the rated currents of the LV HRC fuses do not match those of the transformers. For this reason, LV HRC fuse links with operational class "gTr" have been developed and standardized in Germany specially for protecting distribution network transformers. These are optimized in line with the transformer load-carrying capacity and rated in kVA in accordance with the apparent power of the transformers. This ensures that the utilization of distribution network transformers is optimized with a 400 V secondary voltage.

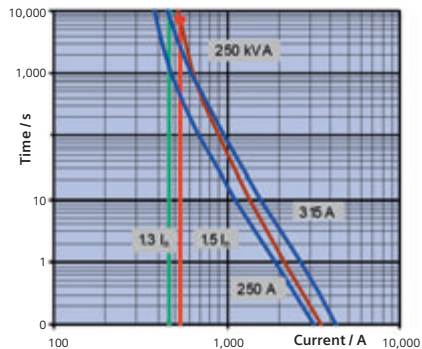

Fig. 5.3.1 – Optimum transformer protection with gTr fuses

gTr fuses can carry 1.3 x their rated current over a period of 10 hours and can disconnect 1.5 x their rated current in just two hours. Fig. 5.3.1 shows an example of the time/current characteristics of a 250 kVA fuse (rated current: 361 A) compared with gG 315 A and 250 A fuses. The main difference here is the steeper characteristic with long melting times. The characteristics are similar for large currents, which is why gG fuses can also generally be used for short-circuit protection.

The fuses behave selectively vis-à-vis the downstream line protection fuses in the distribution board provided that the fuse values fulfill the following conditions:
 $X \text{ [kVA]} \geq Y \text{ [A]}$

This means that a gTr fuse where $X = 250 \text{ kVA}$ or more behaves selectively vis-à-vis the downstream gG fuse where $Y = 250 \text{ A}$. Selectivity vis-à-vis the HV side is defined in VDE 0670-402.

The technical requirements regarding gTr fuses are defined in VDE 0636-2011. gTr fuses have a rated voltage of 400 V and a rated breaking capacity of 25 kA. In this way, the power loss can be minimized to such an extent that 1,000 kVA gTr fuses with a rated current of 1,443 A can be used in LV HRC fuse bases of size 4a even though they are only rated for 1,250 A. It is important to ensure that sufficient connection options are available for the required conductor cross-sections.

gTr fuses are recommended when the transformer capacity is high and there is a risk of overload. In many networks, the thermal capacity of distribution board transformers during operation is significantly lower than the rated power, which is why an overload protection device closely matched with the transformer data is not needed. For this reason, gG fuses, which are more widely available all over the world, are often used to provide low-voltage-side short-circuit protection.

5.4 Protecting Electrical Motor Circuits

In addition to the motor itself and the supply cables, key elements in an electrical motor circuit include the motor starter and the short-circuit protection device. Fig. 5.4.1 shows the structure of a typical electrical motor circuit. (When correctly dimensioned, the cables are automatically protected too.)

The motor starter is responsible for accelerating the motor to the rated speed, ensuring normal operation, and protecting the motor, together with all its associated components, against overload. Motor starter and/or motor contactors to VDE 0660-102 are not usually suitable for interrupting short-circuits. They must be used in conjunction with suitable short-circuit protection devices and protected themselves. These protective elements are not necessarily part of the motor starter.

Fuses have proved to be a cost-efficient and reliable means of protecting against short-circuits in electrical motor circuits. Compared with other protective elements, fuses have much lower let-through currents and let-through Pt values (see section 4.3), which is why fuses are generally the best means available of ensuring short-circuit protection of coordination type "2" (acc. to VDE 0660-102).

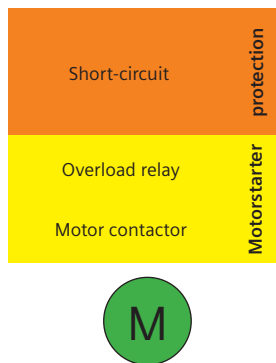

Fig. 5.4.1 – Electrical motor circuit diagram

Coordination type "2" means that:

- The short-circuit current is safely interrupted.
- Neither the operators nor the plant itself are put at risk.
- Having been inspected, the starter can be re-commissioned. Welded contacts that can be easily separated are permitted

Coordination type "1", however, means that the starter or parts of it need to be replaced after a short-circuit.

In the case of processes that require a high level of plant availability, fuses are a more cost-efficient alternative to oversized motor starters. To ensure that fuses are properly coordinated with motor starters, the following conditions must be fulfilled:

- The motors and motor starter are to be protected against the effects of short-circuits.
- To ensure this, the maximum let-through current and let-through energy (I^2t) of the fuse must be less than the corresponding strength of the contactor.
- The transfer current I_C with which the fuse assumes the tripping function of the overload relay must also be below the breaking capacity of the motor contactor (Fig. 5.4.2).
- Malfunctions caused by fuses tripping for no reason are to be avoided.
- To ensure this, sufficient distance must exist between the melting time/current characteristic curve of the fuse and the starting current pulse of the motor. When the motor is switched on directly, this can cause approximately 6 x the rated motor current to flow for 10 s (Fig. 5.4.2).

Depending on the operating conditions of the motor and the utilization category of the fuse, the rated currents of the fuse and motor are not necessarily the same and may, in fact, be much greater. gG fuses and aM fuses are used to protect against short-circuits in electrical motor circuits. The main benefits of gG fuses are their high level of availability and low cost, although they generally need to be one or two rated current steps higher than usual in order to prevent accidental tripping caused by the motor starting current. The main benefit of aM fuses is their slower-acting tripping behavior in the overload range, which ensures optimum protection with maximum plant availability. This means that aM fuses one step lower than the rated motor current can be used. In some countries, type gD and gM fuses are also used to provide full-range protection for electrical motor circuits.

The product documentation for Siemens SIRIUS motor starters contains all the specifications required for ensuring that fuses are correctly coordinated.

5.5 Semiconductor Protection

There are no easy rules for properly coordinating SITOR and SILIZED semiconductor protection fuses, which is why this document only provides a general overview and refers to the SITOR configuration manual for more detailed information.

Different requirements exist and fuses with different operational classes are used depending on the installation location (Figs. 5.5.1 and 5.5.2):

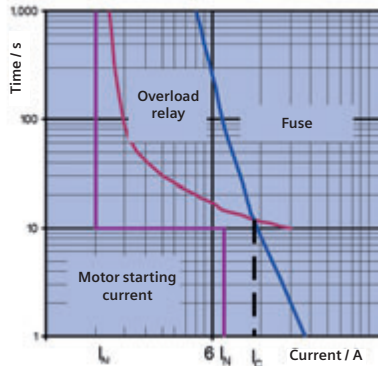

Fig. 5.4.2 – Selection of motor protection fuses

- As arm or cell fuses in semiconductor branches, aR fuses are assigned directly to the semiconductor components as protection devices.
- aR or gR fuses are used as phase fuses in the phase branch of the converter
- On the load (DC) side, gR, gS, or gG fuses are used for overload protection. Selectivity vis-à-vis the upstream - fuses in the rectifier is not possible if a short-circuit occurs.
- Full-range fuses with operational class gR or gS are used in the sub-distribution board and also protect the supply cables. gR fuses are set to lower I_{2t} values, while gS fuses are configured for low power loss due to the fact that they are used in standardized fuse bases and fuse switch disconnectors. Both operational classes can be used for cable overload protection, although only the gS fuses fulfill all the requirements for cable overload protection.

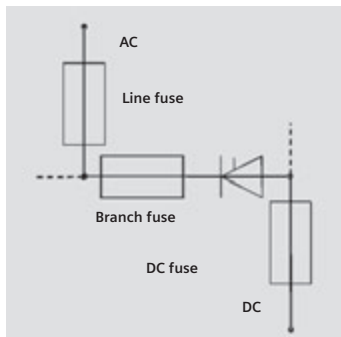

Fig. 5.5.1 – Semiconductor protection, circuit diagram

Fuses for semiconductor protection are selected on the basis of the limit values of the semiconductor components and the prospective load and fault currents at their location of use. The following points must be taken into account:

- **Continuous operational currents**, including permissible overloads, are to be conducted without causing thermal damage. The load current in electrical circuits with semiconductors is rarely sinusoidal, which is why the RMS value must be determined using the curve form in order to determine the thermal load of the fuses.
- At the operational current, the **power loss** of the fuse is to be less than the permissible power consumption of the fuse holder. This is determined using the RMS value and the manufacturer documentation. The SITOR configuration manual contains detailed tables listing the permissible load for SITOR fuse links in suitable fuse bases and holders along with the required connection cross-section.
- For **distinctly pulse-shaped and cyclic load currents**, the SITOR product documentation contains tables listing the varying load factors. Alternatively, overload curves can be shown if required (Fig. 5.5.2). These specify the strength of the load current pulses that do not cause the fuse characteristic curve to change in the selected time range. The fuse elements in SITOR semiconductor fuses are specially designed for high varying load factors.

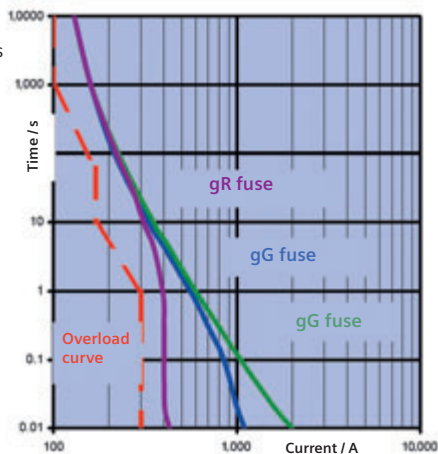

Fig. 5.5.2 – gG, gS, and aR characteristic curves with overload curve

- If **malfunctions occur**, the fault current is to be interrupted before current-carrying semiconductors are destroyed. To ensure this, the let-through current and the tripping integral I^2t of the fuse must be less than the limit values of the semiconductor to be protected. The tripping integral comprises the I^2t values over the melting time and arcing time (Fig. 4.1.3) and depends on the recovery voltage (Fig. 5.5.3). The SITOR configuration manual contains the relevant curves.

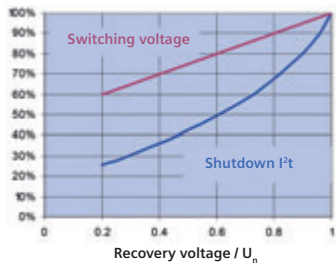

Fig. 5.5.3 – Correction of the switching voltage and tripping integrals

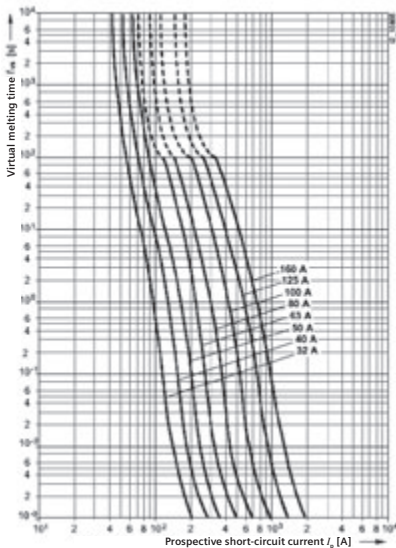

Fig. 5.5.4 – Time/current characteristic curves for SITOR gR and aR fuse links

5.6 Protecting DC Circuits

Current-limiting fuses can be used for both AC and DC applications. It should be noted, however, that the specifications for DC and AC applications are different and the AC data cannot simply be converted to DC data. This can only be determined by means of appropriate tests.

To help you gain a better understanding of how fuses behave in DC applications, the process of interrupting a direct current will be explained:

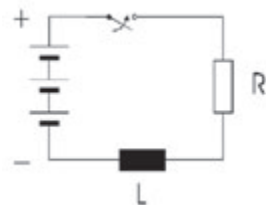

Fig. 5.6.1 – DC circuit

- The switching voltage that occurs when the fuse interrupts the current must not exceed the electric strength of the semiconductor-junction. If the recovery voltages are lower than the rated voltage of the fuse, the switching voltage can be corrected downwards (Fig. 5.5.3).

Note: The characteristic curves of SITOR aR back-up fuses are indicated with dotted lines in the time range $t_{vs} > 100$ s (Fig. 5.5.4). These mark the permissible overload from a cold state. If this limit is exceeded, the fuse body may be damaged. Solid characteristic curves indicate full-range fuses in the melting range.

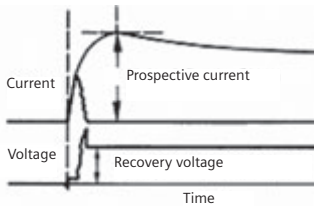

Fig. 5.6.2 – DC short-circuit disconnection

In DC circuits, the time constant $T = L / R$ (Fig. 5.6.1) is a determining variable. It influences not only the breaking capacity but also the time/current characteristic curve and the let-through current.

The greater the time constant, the greater the energy stored in the electrical circuit that is converted in the arc during tripping. Since the energy absorption capacity of a fuse link is limited, the DC-breaking capacity is also limited by the time constant. The current rise when a

fault occurs and, in turn, the melting time of the fuse, as well as the let-through current are also governed by the time constant of the electrical circuit.

Principle: The magnetic energy stored in the electrical circuit determines the limits of the fuse application with direct currents.

Short-circuit disconnections for direct currents have a similar characteristic to that for the current-limiting disconnection of high alternating currents (see Fig. 4.1.3). A high arc voltage is generated in the fuse which, when it exceeds the recovery voltage, forces the current to zero (Fig. 5.6.2). The current rise, however, is determined by the time constants and not the switch-on time or power factor.

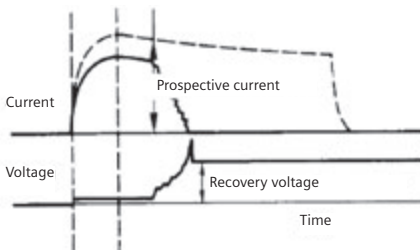

Fig. 5.6.3 – DC overload disconnection

Overload disconnections have a completely different characteristic as compared with alternating currents (Fig. 5.6.3). With direct currents, a periodic zero passage does not occur and, in turn, no torque is present without magnetic energy in the electric circuit with favorable conditions for extinguishing the arc. The arc is not extinguished until the arc voltage exceeds the line voltage, forcing a zero passage. When the direct current is disconnected, the

magnetic energy stored in the electrical circuit must be absorbed by the arc. With this switching operation, therefore, the thermal stress on the fuse is incomparably higher than with an alternating current, which is why the breaking capacity of fuses is generally much lower with direct currents than with alternating currents. Even the high level of dependency of the direct current data on the time constants of the electrical circuit is based on this correlation.

- The **rated direct voltage** of fuse links is generally lower than the rated alternating voltage. In the Siemens product documentation, both rated values are listed separately. The rated DC voltage of fuse bases is at the same level as the rated AC voltage.
- The **rated direct current** is a rated variable that refers only to the thermal properties of the fuse. It is the same as the rated alternating current and is, therefore, not specified separately.
- The **time/current characteristic curves** in the Siemens product documentation specify virtual melting times in compliance with the fuse standards. They are, therefore, based on the assumption that the current jumps immediately to the RMS value when a short-circuit occurs and remains at that level until the fuse melts (see section 4.3). In reality, however, the short-circuit current in the DC circuit increases after a delay in accordance with the time constants.

In the short-time range ($t_{vs} < 20$ time constants), this can result in significant deviations (Fig. 5.6.4). Under stationary conditions (overcurrents with melting times $t_{vs} > 20$ time constants), the standard characteristic curves are identical to the direct current characteristic curves.

Note: The actual melting times with direct currents can be determined on the basis of the virtual time/current characteristic curves by means of an iterative calculation method, which is described in IEC 61818 and E VDE 0636-129.

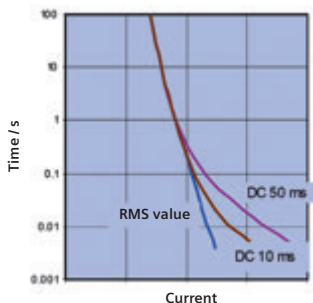

Fig. 5.6.4 – DC characteristic curves

- The **rated breaking capacity** with direct currents is not a fixed property of a fuse. It must always be considered within the context of the time constants of the electrical circuit. High time constants reduce the breaking capacity while low time constants increase the breaking capacity. A number of typical time constants for common applications are listed in Table 5.3. With LV HRC fuses, the breaking capacity (to VDE 0636) is at least 25 kA with a time constant of 15 ms. D fuses have a breaking capacity of at least 8 kA with 15 ms. This covers most control and load circuits in industrial applications. In battery circuits with low time constants, the breaking capacity is much greater; with field coils, however, it is much smaller.
- The **let-through current** also depends on the time constants of the electrical circuit, which means that it cannot be determined on the basis of the alternating current characteristic curves. Special documents, which can be requested from the manufacturer, are required for determining the let-through current.

Application	Time constant
Industrial controllers	≤ 10 ms
Battery circuits	≤ 5 ms
Motors and drives	20 bis 40 ms
Electromagnets	bis 1,000 ms

Table 5.3 – Time constants

5.7 Battery Protection in UPS Systems

Large battery cabinets or stands are connected to the DC link via one-pole SENTRON LV HRC fuse switch disconnectors (Fig. 5.7.1). These are used:

- As a defined interface between the battery and UPS
- To disconnect the battery when maintenance is carried out
- To protect the battery so that the electrodes are not destroyed and to prevent the connection cable from overheating

Battery protection in UPS systems must be considered as a special case for DC applications. The prospective short-circuit current depends on the battery capacity, the battery type, and the extent to which the battery has aged.

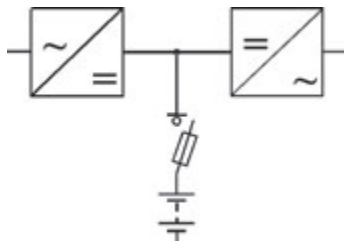

Fig. 5.7.1 – Circuit diagram of a UPS systems

If the UPS system is in service for short periods, the battery capacity and, in turn, the short-circuit current are low compared with the operational current.

For this reason, effective protection is ensured by very steep fuse characteristic curves and can usually only be achieved with SITOR semiconductor fuses (Fig. 5.7.2). Since better protection can be provided the closer the operating point is to the melting characteristic curve, it is important that operators are familiar with the exact characteristic curve tolerances.

Note: For this reason, the decision to implement SITOR fuses in UPS systems should always be the responsibility of the Siemens Customer Service Center.

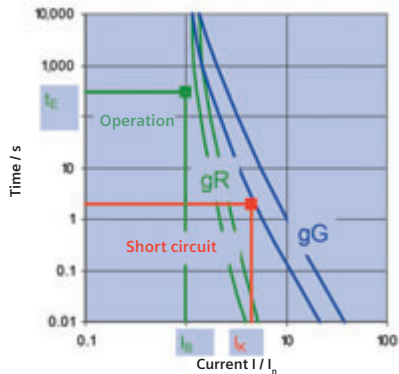

Fig. 5.7.2 – Selection of a battery fuse for UPS systems

The service period of the UPS system is also an important selection criterion. When the rated current is the same, UPS systems optimum protection for short service periods can be ensured by means of smaller fuses, while larger fuses are required for longer service periods:

- The **operating point** (t_c / I_b) must be at a sufficient distance below the lower time/current characteristic curve to ensure that the fuse does not respond during normal operation (Fig. 5.7.2).
- The **maximum operational current of the battery** can be calculated from the active power P_w of the UPS system and the discharge voltage U_E : $I_b = P_w / U_E$. (Toward the end of the service period, the battery voltage decreases to the discharge voltage which, depending on the design, is approx. 85% of the rated battery voltage).
- The **short-circuit point** (I_k / t) must be above the tolerance band of the fuse characteristic curve.
- The **short-circuit current** I_{kr} , which is to be disconnected as quickly as possible (< 10 s), can be calculated on the basis of the battery capacity. Taking into account the effects of aging on the battery and a dramatic decrease in the initial short-circuit current, a value equating to 5 x battery capacity (K) can be used as a reference value: $I_{kr} [A] = 5 K [Ah]$.

Important note: This value only applies when the characteristic curve is selected.

The required breaking capacity of the fuse must be at least 20 x the battery capacity: $I_b [A] \geq 20 K [Ah]$. With the exception of very small batteries, therefore, SITOR or SILIZED fuses are also required with direct voltages less than 80 V.

Battery switches and fuse bases must be able to absorb the power loss of the fuses. Since the limit temperature is not reached over short service periods, the higher rated power dissipation of the semiconductor fuses is not usually critical.

5.8 Capacitor Protection in Reactive-Power Compensation Equipment

The fuse standards IEC 60269 and VDE 0636 define fuses for interrupting inductive currents. Power factors of < 0.1 and capacitive electrical circuits are not recorded. In the absence of any recognized test certificates, it must be assumed that the excellent switching characteristics demonstrated by fuses when interrupting inductive currents cannot be applied to capacitive currents. Despite this, however, gG fuses are commonly used in electrical circuits with capacitors, particularly in reactive-power compensation systems. From a technical point of view, this application is justifiable, provided that certain rules are observed.

The most important rule is that fuses must never trip under the influence of capacitive currents

Melting fuses, therefore, should not be used for protecting capacitors against overload. Capacitors can be protected against overload by means of internal overpressure disconnectors. Melting fuses are only designed to provide protection if internal short-circuits occur and when a capacitor or capacitor battery is jumpered externally. The fuses can manage these inductive fault currents in accordance with requirements. If this rule is not observed, this can have undesirable consequences, particularly in reactive-power compensation systems (Fig. 5.8.1).

Such incidents can be avoided by gaining a better understanding of the special processes that take place in electrical circuits with capacitors and by taking care to choose the right fuse. Important information about the operational requirements regarding capacitors that must be taken into account when fuses are selected can also be found in VDE 0560-46 (self-healing power parallel capacitors). The following general rules should be taken into account when fuses for protecting parallel capacitors are selected:

- Fuses must be able to continuously conduct the **maximum operational current** of the capacitors of $1.5 I_N$ (VDE 0560-46). For this reason, a rated fuse current that is at least 1.6 to 1.8 x the rated capacitor current is recommended.
- Fuses must allow **capacitor starting currents** to pass through unhindered. When capacitors and capacitor banks are energized, this generates very high starting currents up to 100 x the rated capacitor current (Fig. 5.8.2). These high current peaks can damage limiters in the fuse element and gradually reduce the current-carrying capacity. This can lead to overheating and may cause the fuse to trip in an uncontrolled manner. Sufficiently dimensioned fuses (rated current at least 1.6 to 1.8 x the rated capacitor current), leading, resistive starting contacts in the capacitor contactor, or thyristor switches that are activated "softly" in the voltage zero crossover can be used to avoid these problems.
- Fuses and capacitors must not be loaded excessively with **harmonic currents or resonances**. At the line frequency, capacitors have a defined impedance, which almost entirely excludes the risk of overload. Non-linear loads, particularly electronic power supply units and controllers, generate current harmonics, which can place an additional load on capacitors and fuses. In industrial networks, harmonics can easily reach the RMS value of the fundamental component. Possible consequences include overheating and fuses with rated currents that are too small may malfunction (Fig. 5.8.1). If the harmonic component is too high, the only solution is to "choke" (connect inductors in series) the reactive-power compensation system to protect the capacitors against impermissible overloads.



Fig. 5.8.1 – Unsuccessful disconnection of current resonance

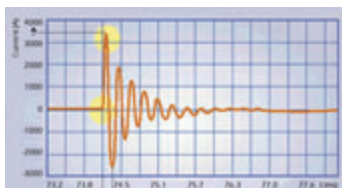

Fig. 5.8.2 – Capacitor starting current

- The choice of fuse should take into account the **compensating currents** between adjacent capacitor banks. If individual capacitor units switch separately or if faults occur, compensation currents flow between the adjacent capacitor banks. In configurations such as this, the fuses for the capacitor units should be rated one or two rated current steps higher. The rated currents of the group fuses should be at least 2.5 x the individual fuses.
- Fuses should be able to manage high **recovery voltages**. Resonances and re-ignition when capacitors are de-energized can generate recovery voltages that exceed the line voltage and, in turn, the rated fuse values.

These occurrences are comparable with the disconnection of long, load-free high-voltage lines and are not particularly important with low voltages. For this reason, a simplified circuit diagram is used here to describe the switching operation (Fig. 5.8.3):

At current zero crossover, the line voltage U_s and the capacitor voltage U_c reach their peak value. If the current is extinguished at the zero crossover, the capacitor voltage is maintained while the line voltage approaches the opposing peak value (Fig. 5.8.4). The recovery voltage at the fuse U_f reaches double the peak value (or as much as 2.5 x this value in three-phase systems) within 5 ms. If re-ignition occurs here, the capacitor is suddenly recharged with the opposing polarity and the recovery voltage continues to rise.

Multiple re-ignition can destroy the fuse and adjacent plant components. The risk that fuses cannot manage the switching operation due to excessive recovery voltages can be minimized by selecting a higher rated fuse voltage vis-à-vis the operational voltage and using longer fuse bodies (larger sizes).

Table 5.3 provides an overview of the LV HRC fuse links (utilization category gG) recommended in the application guidelines IEC 61818 and E VDE 0636-129 for common reactive-power compensation systems in three-phase systems with different operational voltages. The re-recommended fuses are designed to minimize the risk of faults, taking into account the above-mentioned criteria.

In plants of different sizes, the rated fuse current can be determined on the basis of the factor k , which is dependent on the operational -voltage, using the following empirical formula:

$$I_N / A \geq k \times Q_N / \text{kvar.}$$

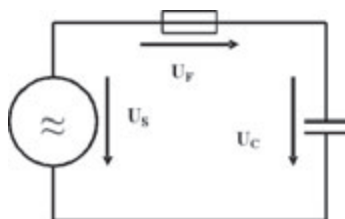

Fig. 5.8.3 – Circuit diagram of a capacitive electrical circuit

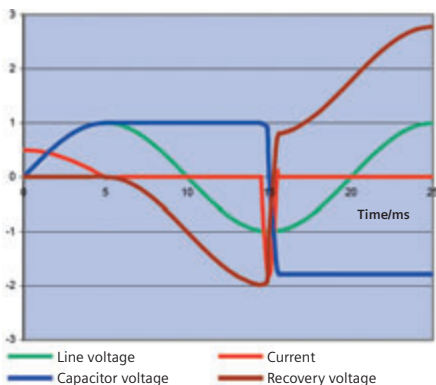

Fig. 5.8.4 – Capacitor disconnection diagram

In "choked" systems and when more information about the network conditions is available (after a net-work analysis), fuses with a rated current one step lower than usual can be used in exceptional cases.

	Rated voltage (three-phase system)		
Reactive-power compensation system	400 V (k = 2.5)	525 V (k = 2)	690 V (k = 1.5)
Fuse link	500 V	690 V	1,000 V *)
Apparent power Q_N / kvar	Rated current I_N of LV HRC fuse		
≤ 5	16 A		
≤ 7.5	20 A		
≤ 12.5	35 A	35 A	
≤ 20	50 A		35 A
≤ 25	63 A	50 A	
≤ 30	80 A	63 A	50 A
≤ 40	100 A	80 A	63 A
≤ 50	125 A	100 A	80 A
≤ 60	160 A	125 A	100 A
≤ 80	200 A	160 A	125 A
≤ 100	250 A	200 A	160 A
≤ 125	315 A	250 A	200 A
≤ 160	400 A	315 A	250 A
≤ 200	500 A	400 A	315 A
≤ 250	630 A	500 A	400 A
*) Alternatively, 690 V in minimum size LV HRC 1			

Table 5.4 – Selection of LV HRC fuse for reactive-power compensation systems

5.9 Special Applications and Environmental Conditions

The fuse standards define the function for standard applications under normal ambient conditions. If the application conditions differ from those specified in the standard, you should always obtain expert advice from your local Siemens Customer Service Center. This helps ensure that fuses are deployed in the right applications, thereby preventing any damage or malfunctions. For this reason, the following explanations do not contain any specific recommendations regarding applications, but simply provide examples of special conditions and information about the various aspects of the fuse application that must be taken into account under these conditions.

Ambient temperatures of > 40°C

do not significantly affect the function of back-up fuses in any way. Their tripping behavior remains practically the same (aR fuses in Fig. 5.9.1). With a melting temperature of 960 °C (silver), other ambient temperatures do not have any significant effect on the tripping behavior. Note, however, the various limit temperatures for contacts and conductor connections that could limit the permissible operational currents.

In the case of full-range fuses (e.g. gG fuses) with melting temperatures below 200 °C, the characteristic curves can shift to lower melting currents which, in turn, significantly reduces the load-carrying capacity at high temperatures. The load-carrying capacity curves in Fig. 5.9.1 apply to fuses whereby the surrounding air is convected unimpeded in the distribution board. Unimpeded convection in compact enclosures or forced cooling must be considered separately (see below).

Ambient temperatures of < 5 °C

are not critical for fuses. The melting times of full-range fuses increase slightly, although this increase is negligible with back-up fuses.

Plastic parts can become brittle and break more easily when subject to impact stress (slewing equipment and grip lugs). Restrictions arising from this are noted in the Siemens product data sheets.

Low ambient temperatures generally have a positive effect on the electrical load-carrying capacity of fuses and switchgear assemblies.

LV HRC fuses in enclosures

Number of electrical circuits	Load factor
1	1
2 - 3	0,9
4 - 5	0,8
6 - 9	0,7
≥ 10	0,6

Table 5.5 – Load factors in distribution boards (IEC 60947-1)

The load-carrying capacity of LV HRC fuses in enclosures with a high packing density and with restricted heat dissipation can also only be determined by means of temperature rise tests. The limit temperatures defined in the applicable standards are rarely useful in this regard. Neither the maximum permissible air temperature (40 °C measured at a distance of 1 meter) nor the limit temperature of the conductor connections determined by the use of PVC-insulated conductors (65 K) are suitable for determining the load-carrying capacity of fuses.

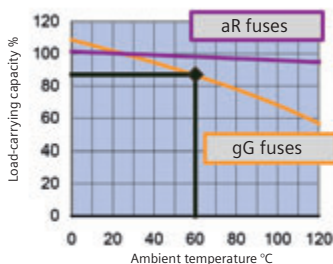

Fig. 5.9.1 – Load-carrying capacity of melting fuses

When a number of fuses and other devices that emit heat are installed in one enclosure, the size of the enclosure and the cooling type limit the load-carrying capacity. The temperature rise test to VDE 0660-500 (low-voltage switchgear and controlgear assemblies) takes into account the fact that not all electrical circuits are generally fully loaded at the same time and, depending on the number of circuits, a load factor of < 1 is used in the temperature rise tests (Table 5.5). This applies if the plant manufacturer has not specified any other values.

With certain fuse base designs, particularly those for busbar mounting, the conductor connection terminals across long busbar supply cables are practically thermally decoupled from the fuse. In this case, of course, the terminal temperature does not give any indication of the fuse load-carrying capacity.

Note: VDE 0636 defined a nationwide limit temperature of 55 °C for the air immediately surrounding gG fuses in enclosures, at which the fuses were not permitted to trip. This value, however, was not included in the international standards and was eventually removed from VDE 0636.

Since no generally-applicable rules apply regarding the load-carrying capacity of LV HRC fuses in real applications, an application recommendation was elaborated by an international work group (IEC SC 32 B WG 14) (IEC 61818, draft VDE 0636-129). Here, the fuse knife contact temperature is recommended as an evaluation criterion for LV HRC fuses with operational class gG with the following justification:

- The maximum load-carrying capacity of LV HRC fuses during operation is determined by the temperature of the fuse element.
- Fuse knife contacts are the closest points to the fuse element at which temperature measurements can be easily made.
- A close thermal link exists between the solid blade contacts and fuse element allowing the temperature to be accurately determined.
- This method can be used for all fuse designs and installation conditions.
- Requirements for LV HRC fuses with operational class gG are strictly defined in the standard to the extent that they behave in exactly the same way, regardless of the manufacturer.

The work group proposed a limit temperature of 120 °C for gG fuses, which must not be exceeded during the temperature rise test with the rated operational current in accordance with the standard that applies to the switchgear.

Continuous operation at this temperature can reduce the expected service life of the fuse. If the corresponding current load during operation is expected to be present for a very long period and not just a few hours, a limit temperature of 100 °C should be observed.

With other Siemens fuse types, particularly those with screw connections, other limit temperatures may apply. These should be coordinated with the Siemens Customer Service Center.

Humidity and contamination

do not have any effect on how the fuses operate. High levels of contamination and humidity, however, can jeopardize insulating distances and encourage rust. For LV HRC fuse links that are to be used when contamination levels of ≥ 3 (VDE 0110-1) are present (e.g. in cable distribution cabinets with high levels of salt), a more stringent corrosion test can be agreed upon in accordance with VDE 0636-201.

Corrosive atmospheres

Atmospheres with high levels of sulfur or ammonia in chemical plants or in livestock agricultural environments can damage silver-plated contacts due to higher levels of corrosion. Tin or nickel-coated contacts are better suited to such conditions. Note, however, that these contact surfaces have lower limit temperatures. They generally require a reduction factor that practically rules out the maximum rated currents of the different sizes. One exception here is the pure back-up fuse (e.g. in reactive-power compensation systems). Compared with the silver-plated version, nickel-plated LV HRC contacts in LV HRC fuse bases or switching devices require a higher contact pressure.

Note: For advice regarding the correct surface coating for the contacts on fuse bases and fuse links, as well as the reduction factors to be applied, contact your local Siemens Customer Service Center.

Note 1: Reactive current compensation plants in factories with a corrosive atmosphere have proven to be particularly critical because the lower thermal load-carrying capacity of nickel-plated LV HRC contacts is subject to an additional current load due to harmonics. The rated fuse current should be as high as possible in plants such as this (see also sections 4.5 and 5.8).

Note 2: The limit temperature for nickel-plated contacts is not clearly defined in VDE 0636. On the one hand, a limit temperature of 70 K is specified but, on the other hand, a footnote states that this is "limited only by the condition that adjacent components are not damaged". This would mean that nickel-plated contacts are the same as silver-plated contacts, although the painful experiences of many manufacturers and operators prove otherwise. This was taken into account in the D fuse standard -VDE 0636-301, which permits nickel-plated contacts at low rated currents only. Silver-plated contacts are prescribed as of a rated current of 63 A due to the high temperatures that can be generated.

Unusual vibrations and impact loads

If special measures are required to prevent fuse links from becoming dislodged (e.g. due to impacts), screw locking devices and locking devices for the fuse links in the holder or fuse carrier can generally be used. Such measures may need to be taken in earthquake zones, on ships, or in rail vehicles. The Siemens product documentation contains information about suitability of SENTRON fuse switch disconnectors on ships.

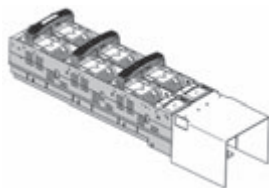

Fig. 5.9.2 – Twin switching strip

Parallel connection of fuses

Connecting LV HRC fuses in parallel is a common means of extending the rated current range for a particular size. In this way, a low-voltage distribution board can be made more compact, for example, if two LV HRC 3 strips are connected in parallel to supply the busbar instead of one LV HRC 4a strip (Fig. 5.9.2). It is also common practice in wind power plants to connect several LV HRC fuse strips or in-line fuse switch disconnectors in parallel for the low-voltage-side supply. LV HRC fuses are also usually connected in parallel to protect semiconductors. If suitable, pre-installed fuse holders have not already been provided by the manufacturer, certain important rules and information must be observed with regard to connecting fuses and safety switching devices in parallel:

- The fuse links must have the same design, size, and rated data (they should preferably be identical).
- Incoming and outgoing cables should distribute the current evenly. This should be verified by means of appropriate measurements when longer cables are used. Alternatively, the cable connections are interconnected (Fig. 5.9.3). In this case, however, the connected cables are only protected jointly, not individually.
- LV HRC fuse switch disconnectors connected in parallel should have mechanically-connected operating levers that can be operated without the use of excessive force (Fig. 5.9.2).

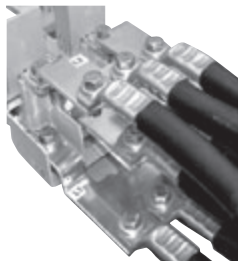

Fig. 5.9.3 – Cable connection area

- Since the current is not distributed evenly, the rated current of n parallel fuse links is always less than the sum of the rated currents $n \times I_n$.

Exception: Several parallel SITOR semiconductor fuses can be assigned to a semiconductor element without reducing the current.

- The melting integral of n parallel fuses is approximately $n^2 \times I^2 t$ of the individual fuses.
- The let-through current of n parallel fuses is approximately $n \times I_c$ of the individual fuses when a prospective short-circuit current I_p is present.
- The breaking capacity of the assembly cannot be greater than I_b of the individual fuses.
- With LV HRC back-up fuses, the breaking range (minimum breaking current) does not begin below $n \times k^2 I_n$.
- To determine the temperature rise, the full operational current for all n parallel switching devices- must be assumed because only one load circuit is involved. The load factors in Table 5.4 cannot be applied.

Series connection of fuses

Unlike parallel connection, series connection does not generally allow for a wider range of applications or the rated voltage to be increased. Due to certain, unavoidable product tolerances, it must always be assumed that, even when identical fuses are connected in series, each individual fuse must be able to interrupt the current when the full recovery voltage is present.

Exception: With SITOR semiconductor fuses, it can be assumed that the voltage is evenly distributed once it has been established that the prospective short-circuit current results in melting times of ≤ 10 ms. For type-specific specifications, see the SITOR configuration documents.

5.10 Protecting Photovoltaic Systems

The rapid rise of regenerative power generation, particularly photovoltaic, opened up a new area of application for DC fuses. The generation voltages can be as high as 1,000 V a.c., which is not unusual for high-voltage current fuses. What is more difficult, however, is finding the right characteristic. Solar cells supply an almost load-independent current which, even when a short-circuit occurs, is defined (i.e. limited) by the solar radiation. Operating and fault currents are so close to each other that fuses with very steep characteristic curves (such as those for SITOR and SILIZED semiconductor fuses) are required for providing effective protection. The operational requirements regarding fuses for photovoltaic systems are comparable with those of UPS (uninterruptible power supply) systems, although requirements are much more stringent with respect to the service life of the fuses under varying loads. Premature tripping of fuses caused by fatigued fuse elements is unacceptable because this can cause interruptions and decreases of payments. If a fuse does not respond or malfunctions in the event of fault, this can prove even more costly and must be avoided. Due to a lack of experience in this new technology, general rules for selecting and testing fuses for photovoltaic applications have yet to be defined. For this reason, Siemens is working very closely with manufacturers of photovoltaic systems with a view to offering comprehensive solutions – from main circuit breakers to devices designed to protect against overvoltage, fault currents, and overcurrents – for this new area of application.

6 SIMARIS design

The process of dimensioning electrical power distribution systems for functional and industrial buildings has never been easy and is today more complex than ever. Siemens can help you with this difficult task, however, with its dimensioning software SIMARIS design.



Fig. 6.1 – User-friendly SIMARIS design interface

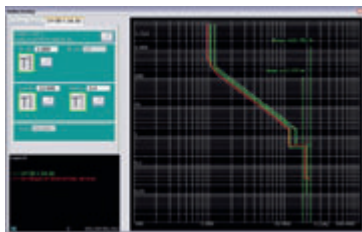

Fig. 6.2 – Safe Selectivity - selectivity based on real product characteristic values

In addition to the network structure and the right equipment, it is essential that systematic selective protection is configured to ensure the reliability and availability of your plant. This guide to fuses demonstrates how fuses can be used to fulfill a wide range of protection tasks as efficiently as possible. The ability to select the right fuses and coordinate them with other protective elements for electrical power distribution requires not only a sound basic understanding of fuses, but also extensive, detailed knowledge and comprehensive product information. Without this knowledge and if sufficient time is not devoted to consulting the information available, the safety and reliability of electrical systems can be compromised and the options for ensuring that power distribution networks are properly protected cannot be fully leveraged.

On the basis of the requirements of the different electrical power distribution systems, SIMARIS design can help you dimension a reliable solution from the wide range of available products in accordance with recognized rules of technology and the applicable standards (VDE, IEC). Your entries are checked and, if necessary, corrected automatically by SIMARIS design. Since real product characteristic values are used for the configuration, the projects created with SIMARIS can be reliably implemented. SIMARIS design also includes any changes in the supply concept and automatically checks whether these are permissible with respect to the current, applicable regulations and conditions. The tool also provides clearly-structured documentation (e.g. with BOMs or overviews) in a range of formats (RTF, PDF, and DXF). SIMARIS has been certified by TÜV (German Technical Inspectorate) Berlin due to its high level of quality.

SIMARIS design is a key component of Totally Integrated Power™, the innovative platform for systematic power distribution systems from Siemens. This technological platform comprises a range of tools and support packages for planning and configuration purposes, a harmonized, comprehensive range of products and systems, as well as a communication interface with higher-level operator control and monitoring/host and management systems.

As a result, SIMARIS design minimizes the time and effort involved in planning power distribution systems and gives you the head-start you need.

7 National and International Fuse Standards

The most important technical characteristics of low-voltage fuses are standardized globally in the international standards IEC 60269-1 (and follow-up sections). This makes it easier to select the right fuse and replace fuses. The European standards (EN) are largely identical to IEC, although they may contain additional information relevant to European countries. With just a few exceptions, the German standards (DIN VDE) and other national standards in Europe are translations of the international standards.

Special rules relating to LV HRC and D fuses apply for low-voltage fuses. To prevent the potentially hazardous confusion of fuses in different systems, a European harmonization document instead of a European standard has been created for the fuses systems defined in IEC 60269-2-1 and 60269-3-1. Although the document covers all of the IEC systems, these do not necessarily have to be included in the national standards. For safety reasons, only the LV HRC and D/D0 system have been included in the German standard DIN VDE 0636 (Table 7.1).

The table also includes certain VDE regulations that do not have an international equivalent. This concerns:

- LV HRC fuses for transformer protection
- LV HRC fuses for protecting equipment in the mining industry
- 1000 V fuses for protecting electrical motor circuits
- NDz fuses with an E 16 thread up to 25 A
- D fuses up to 750 V for electric railways
- D fuses up to 500 V for the mining industry
- 690 V D0 fuses
- D0 fuse combination units

Table 7.1 takes into account the new structure (bold type) of IEC 60269 and VDE 0636. Standards in parentheses are either no longer or not yet valid.

This new structure makes the standard much clearer because it now contains a maximum of two parts (see below) where once it contained three:

- Part 1: "General requirements"
- A follow-up section containing additional requirements for special conditions of use or applications

They must be read together. In future, the "Guidelines for the Applications of Low-Voltage Fuses" will be included in the standard as Part 5. In addition to IEC 61818 (E VDE 0636-129), this will contain IEC 61459, which has not yet been published in Germany.

Although it is not defined in any standards, the DL fuse system, which is manufactured on the basis of an old East German factory standard, is still of importance to operators. This relates to screw-in fuse-links of size E 16, which are not compatible, however, with the E 16 system (acc. to VDE 0635) and are also non-interchangeable.

IEC	VDE	Content / Siemens products
60269-1	0636-1 (0636-10)	General requirements
60269-2	0636-2	Fuses for use by authorized persons or persons trained in electrical engineering / LV HRC fuses, operational classes gG, aM
(60269-2) (60269-2-1)	(0636-20) (0636-201)	Examples of standardized systems of fuses (e.g. LV HRC system)
	0636-2011	National supplement 1: Protection of special electrical systems / LV HRC fuses with operational classes gTr, gB, and aM 1,000 V a.c.
60269-3	0636-3	Fuses for use by unskilled persons
(60269-3) (60269-3-1)	(0636-30) (0636-301)	Examples of standardized systems of fuses (DIAZED, NEOZED D0 system)
	0636-3011	National supplement 1: U = 690 V a.c. and U = 600 V d.c.
60269-4	0636-4	Fuses for the protection of semiconductor devices
(60269-4) (60269-4-1)	0636-40 0636-401	Examples of standardized systems of fuses / SITOR fuse links with operational classes aR, gR and gS
61818, 61459 (IEC 60269-5)	E 0636-129 (0636-5)	Guidelines for using low-voltage fuses
	0635	NDz fuses E 16 to 25 A, 500 V; DIAZED fuses up to 100 A, 750 V; 500 V
	0638	Low-voltage switchgears - fuse-switch-units - D0-System / MINIZED
60947-3	0660-107	Switches, disconnectors, switch-disconnectors and fuse-combination units / SENTRON fuse switch

Table 7.1 – Standards for low-voltage fuses

8 Appendix

Size	Operating class						
	gG	gTr	gB	gR/gS	aR	aM	Messer
000	2 – 100 A	- / -	6 – 100 A	6 – 80 A	6 – 80 A	6 – 100 A	250 A
00	2 – 160 A	- / -	16 – 125 A	16 – 160 A	80 – 160 A	16 – 160 A	250 A
1	6 – 250 A	- / -	16 – 250 A	35 – 250 A	32 – 250 A	25 – 250 A	400 A
2	25 – 400 A	50 – 250 kVA	16 – 400 A	80 – 400 A	160 – 400 A	80 – 400 A	630 A
3	315 – 630 A	50 – 400 kVA	- / -	315 – 630 A	315 – 630 A	125 – 630 A	1,000 A

Table A.3.13 – Applications of LV HRC fuse links

Size	gG						aM			
	400 V a.c.		500 V a.c.		690 V a.c.		400 und 500 V a.c.		690 V a.c.	
	I _n	P _n	I _n	P _n	I _n	P _n	I _n	P _n	I _n	P _n
	A	W	A	W	A	W	A	W	A	W
000	100	5.5	100	7.5	63	12	100	7.5	80	12
00	160	12	160	12	100	12	100/160	7.5/12	160	12 ^{*)}
0 ^{*)}	160	12	160	16	100	25	160	16	100	25 ^{*)}
1	250	18	250	23	200	32	250	23	250	32 ^{*)}
2	400	28	400	34	315	45	400	34	400	45 ^{*)}
3	630	40	630	48	500	60	630	48	630	60 ^{*)}
4	–	–	1,000	90	800	90	1,000	90	1,000	90 ^{*)}
4a	1,250	90	1,250	110	1,000	110	1,250	110	1,250	110 ^{*)}

^{*)}Size LV HRC 0 is no longer permitted for new installations, with the exception of the version featuring a striking pin
^{**)}Rated values for the power that can be absorbed by fuse bases and fuse holders

Table A.4.5.2 – Maximum values of the rated currents and power dissipation of LV HRC fuse links

Size	D01	D02	D03	D II	D III	D IV
Rated current	16 A	63 A	100 A	25 A	63 A	100 A
Power that can be absorbed	2.5 W	5.5 W	7.0 W	4.0 W	7.0 W	9.0 W

Table A.4.5.3 – Power that can be absorbed by D fuse bases

Insulating material	PVC																							
	H07V-U, H07VR, H07V-K, NYFE, NYFEY, NYM, NYMZ, NYMT, NHYRULZ, NYBYL, NYDY, NHXXH, NHMH, NY, NYC																							
Type ID	70 °C																							
Operating temperature on line	30 °C																							
Ambient temperature	30 °C																							
Cable installation type (reference installation type)	A1			A2			B1		B2		C		E											
	Installation in thermally-insulated walls			Multi-strand cable or multi-strand light plastic-sheathed cable in wiring conduit in thermally-insulated wall			Single-core, non-sheathed cables in wiring conduit in wall		Multi-strand cables or multi-strand light plastic-sheathed cable in wiring conduit on wall		Single or multi-strand cable or single-core multi-strand light plastic-sheathed cable		Installation in free air											
No. of loaded cores	I_1	I_2	I_3	I_1	I_2	I_3	2	3	2	3	2	3	2	3										
	I_1	I_2	I_3	I_1	I_2	I_3	I_1	I_2	I_1	I_2	I_1	I_2	I_1	I_2										
Rated cross-section of copper cable in mm ²	Current-carrying capacity I_n in A and rated current I_n of assigned gG-t fuse in A																							
1.5	15.5	13	13.5	13	15.5	13	13.0	13	17.5	16	15.5	16	15.0	13	19.5	16	17.5	16	22	20	18.5	16		
2.5	19.5	16	18	16	18.5	16	17.5	16	24	20	21	20	23	20	27	25	24	20	30	25	25	25	30	25
4	26	25	24	20	25	25	23	20	32	25	28	25	30	25	27	25	36	35	40	35	40	35	40	35
6	34	25	31	25	32	32	29	25	41	35	36	35	38	35	34	32	46	40	51	50	51	50	43	40
10	46	40	42	40	43	40	39	35	57	50	50	50	52	50	46	40	63	63	57	50	70	63	60	50
16	61	50	56	50	57	50	57	63	68	63	68	63	69	63	62	50	85	80	76	63	94	80	80	80
25	80	80	73	63	75	63	68	63	101	100	89	80	90	80	80	80	112	100	96	80	119	100	101	100
35	99	80	89	80	92	80	83	80	125	100	110	100	111	100	99	80	138	125	119	100	148	125	126	125
50	-	-	-	-	-	-	-	-	-	-	-	-	-	-	-	-	-	-	-	-	180	160	153	125
70	-	-	-	-	-	-	-	-	-	-	-	-	-	-	-	-	-	-	-	-	232	200	196	160
95	-	-	-	-	-	-	-	-	-	-	-	-	-	-	-	-	-	-	-	-	282	250	238	200
120	-	-	-	-	-	-	-	-	-	-	-	-	-	-	-	-	-	-	-	-	328	315	276	250

Table A.4.5.4 – Load-carrying capacity of cables and lines in fixed installations in buildings

List of figures and tables

Page 7, Fig. 1.1:	Electrical power distribution within buildings
Page 7, Fig. 1.2:	Customer benefits offered by Totally Integrated Power
Page 8, Fig. 1.3:	Fuses are key components of BETA low-voltage circuit protection
Page 8, Fig. 2.1:	Fuse insert with Edison thread (around 1900)
Page 9, Fig. 2.2:	Two-piece screw-in fuse-link from Siemens-Schuckertwerke (around 1904)
Page 9, Fig. 2.3:	DIAZED dimension standard
Page 10, Fig. 2.4:	Practical and visually appealing: DIAZED 1907
Page 10, Fig. 2.5:	Easy-to-remember colors
Page 11, Fig. 2.6:	Compact N DIAZED system 1927
Page 11, Fig. 2.7:	Comparison of the NEOZED(D0) and DIAZED(D) fuse system
Page 11, Fig. 2.8:	Plug-in porcelain cartridges (1910)
Page 12, Fig. 2.9:	Map showing fuse standards
Page 13, Fig. 3.1.1:	Components of a NEOZED fuse
Page 13, Fig. 3.1.2:	Adapter sleeves
Page 14, Fig. 3.1.3:	Non-interchangeability
Page 14, Table 3.1:	Permissible fuse replacement under voltage
Page 15, Table 3.2:	Siemens screw-in fuse-link systems
Page 15, Fig. 3.1.4:	DIAZED® characteristics
Page 15, Table 3.3:	DIAZED® fuse system
Page 16, Fig. 3.1.5:	SILIZED® semiconductor fuse
Page 16, Fig. 3.1.6:	DIAZED® system components
Page 16, Fig. 3.1.7:	NEOZED® modular system
Page 17, Table 3.4:	Dimensions and power dissipation of NEOZED and DIAZED
Page 17, Fig. 3.1.8:	NEOZED® screw caps
Page 18, Fig. 3.1.9:	NEOZED system components
Page 18, Fig. 3.1.10:	Just 18 mm wide: MINIZED fuse switch disconnectors
Page 18, Fig. 3.2.1:	LV HRC fuse
Page 19, Fig. 3.2.2:	LV HRC fuse link
Page 19, Fig. 3.2.3:	LV HRC fuse links with combination alarm
Page 20, Fig. 3.2.4:	Actuating LV HRC fuse links under load
Page 21, Fig. 3.2.5:	LV HRC fuse puller with sleeve
Page 21, Fig. 3.2.6:	Insulator symbols
Page 22, Fig. 3.2.7:	Lyra contact of an LV HRC fuse base
Page 22, Fig. 3.2.8:	Fuse holder (fuse base with slewing equipment)
Page 23, Fig. 3.2.9:	Comprehensive range of LV HRC accessories
Page 24, Fig. 3.3.1:	Tandem fuse base
Page 24, Fig. 3.3.2:	Meter cabinet

Page 25, Table 3.5:	Busbar systems
Page 25, Fig. 3.3.3:	Distribution board with LV HRC in-line fuse switch disconnectors
Page 25, Fig. 3.3.4:	Bus-mounting elements on the SR60 busbar system
Page 26, Table 3.6:	Continuous current-carrying capacity of SR60
Page 27, Fig. 3.3.5:	SR60 busbar system
Page 27, Fig. 3.3.6:	Busbar infeed
Page 27, Fig. 3.3.7:	NEOZED fuse base on busbar
Page 28, Table 3.7:	Infeed current I_e
Page 28, Fig. 3.4.1:	Cylindrical fuse system
Page 28, Table 3.8:	Siemens cylindrical fuses
Page 29, Table 3.9:	Interchangeable cylindrical fuses 10 x 38
Page 30, Fig. 3.4.2:	Class CC fuse system
Page 31, Fig. 3.5.1:	Fuse element of a semiconductor fuse
Page 32, Fig. 3.5.2:	SITOR fuse element basket
Page 32, Fig. 3.5.3:	SITOR fuse designs
Page 33, Fig. 3.5.4:	SITOR fuse with striker and alarm switch
Page 34, Fig. 3.6.1:	Switch disconnector with fuses
Page 34, Fig. 3.6.2:	SENTRON LV HRC fuse switch disconnectors
Page 36, Table 3.10:	Labeling of fuse combination units to IEC 60947-3
Page 36, Table 3.11:	Utilization categories of fuse combination units to IEC 60947-3
Page 37, Table 3.12:	Switching frequencies by utilization category
Page 37, Fig. 3.6.3:	MINIZED switch disconnectors D02 with busbars
Page 38, Fig. 3.6.4:	a) MINIZED D02 with auxiliary switch for remotely monitoring the switch position b) NEOZED bar-mounting switch disconnectors D02
Page 38, Fig. 3.6.5:	MINIZED switch disconnector system D02
Page 39, Fig. 3.6.6:	SENTRON LV HRC fuse combination units
Page 40, Fig. 3.6.7:	SENTRON LV HRC fuse switch disconnectors with "quick make operation"
Page 40, Fig. 3.6.8:	SENTRON switch disconnectors with LV HRC fuses
Page 41, Fig. 3.6.9:	SENTRON LV HRC in-line fuse switch disconnectors
Page 41, Fig. 3.6.10:	SENTRON plug-in in-line switch disconnectors with LV HRC fuses
Page 42, Fig. 3.6.11:	LV HRC distribution boards with SENTRON in-line switch disconnectors
Page 43, Fig. 3.6.12:	SENTRON LV HRC in-line switch disconnectors
Page 44, Fig. 3.7.1:	Signal detector
Page 44, Fig. 3.7.2:	Fuse monitor
Page 45, Fig. 3.7.3:	Fuse monitor with SIRIUS circuit breaker
Page 45, Fig. 3.7.4:	Electronic fuse monitor
Page 46, Fig. 3.7.5:	SENTRON LV HRC in-line fuse switch disconnector with integrated current transformers

Page 46, Fig. 3.8.1:	Electronic fuse monitor
Page 47, Fig. 3.8.2:	Sand filling for LV HRC fuse links
Page 48, Fig. 3.8.3:	Environmental protection in practice
Page 49, Fig. 3.8.4:	Trademarks of the association NH-HH Recycling e.V.
Page 49, Fig. 3.8.5:	Recycling processes for LV HRC and HV HRC fuses
Page 49, Fig. 4.1.1:	Temperature distribution in the fuse element
Page 50, Fig. 4.1.2:	Short-circuit disconnection
Page 50, Fig. 4.1.3:	Short-circuit current limiting
Page 50, Fig. 4.1.4:	LV HRC fuse element
Page 51, Fig. 4.1.5:	Solder reaction at overload tripping
Page 51, Fig. 4.1.6:	Effect of the solder on the time/current characteristic curve
Page 52, Fig. 4.2.1:	LV HRC labeling
Page 52, Fig. 4.2.2:	D system indicators
Page 53, Table 4.2.1:	Color coding for LV HRC fuses
Page 53, Fig. 4.2.3:	Kennmelder D-System
Page 53, Table 4.2.2:	Color coding for D fuses
Page 54, Fig. 4.3.1:	Time/current characteristic curves
Page 54, Fig. 4.3.2:	Real and virtual times
Page 55, Fig. 4.3.3:	I^2t characteristic curves
Page 56, Fig. 4.3.4:	Let-through current characteristic curves
Page 56, Fig. 4.3.5:	Short-circuit current characteristic in a three-phase system
Page 57, Fig. 4.4.1:	Selective protection in a radial network
Page 58, Fig. 4.4.2:	Circuit breaker upstream of the fuse
Page 58, Fig. 4.4.3:	Fuse upstream of the circuit breaker
Page 59, Fig. 4.4.4:	Selective protection in service box
Page 59, Fig. 4.4.5:	Selectivity limits
Page 59, Table 4.4.1:	Tripping behavior
Page 60, Fig. 4.4.6:	Nodes in meshed networks
Page 61, Fig. 4.5.1:	Standby consumption values for electronic devices
Page 61, Fig. 4.5.2:	Power dissipation values
Page 62, Table 4.5.1:	Power that can be absorbed by LV HRC fuse bases
Page 62, Fig. 4.5.3:	Power dissipation of LV HRC fuse links
Page 63, Fig. 4.5.4:	Power dissipation of 100 A gG fuse links
Page 63, Fig. 4.5.5:	Power dissipation of gG fuses with different rated currents
Page 64, Table 5.1:	Permissible rated voltage
Page 65, Table 5.2:	Operational classes and applications
Page 66, Fig. 5.3.1:	Optimum transformer protection with gTr fuses
Page 67, Fig. 5.4.1:	Electrical motor circuit diagram
Page 68, Fig. 5.4.2:	Selection of motor protection fuses

Page 69, Fig. 5.5.1:	Semiconductor protection, circuit diagram
Page 69, Fig. 5.5.2:	gG, gS, and aR characteristic curves with overload curve
Page 70, Fig. 5.5.3:	Correction of the switching voltage and tripping integrals
Page 70, Fig. 5.5.4:	Time/current characteristic curves for SITOR gR and aR fuse links
Page 71, Fig. 5.6.1:	DC circuit
Page 71, Fig. 5.6.2:	DC short-circuit disconnection
Page 72, Fig. 5.6.3:	DC overload disconnection
Page 72, Fig. 5.6.4:	DC characteristic curves
Page 72, Table 5.3:	Time constants
Page 72, Fig. 5.7.1:	Circuit diagram of a UPS system
Page 73, Fig. 5.7.2:	Selection of a battery fuse for UPS systems
Page 74, Fig. 5.8.1:	Unsuccessful disconnection of current resonance
Page 74, Fig. 5.8.2:	Capacitor starting current <i>v</i>
Page 75, Fig. 5.8.3:	Circuit diagram of a capacitive electrical circuit
Page 75, Fig. 5.8.4:	Capacitor disconnection diagram
Page 76, Table 5.4:	Selection of LV HRC fuse for reactive-power compensation systems
Page 77, Fig. 5.9.1:	Load-carrying capacity of melting fuses
Page 77, Table 5.5:	Load factors in distribution boards (IEC 60947-1)
Page 79, Fig. 5.9.2:	Twin switching strip
Page 81, Fig. 5.9.3:	Cable connection area
Page 81, Fig. 6.1:	User-friendly interface for SIMARIS design
Page 81, Fig. 6.2:	Safe Selectivity - selectivity based on real product characteristic values
Page 83, Table 7.1:	Standards for low-voltage fuses
Page 84, Table A.3.13:	Applications of LV HRC fuse links
Page 84, Table A.4.5.2:	Maximum values of the rated currents and power dissipation of LV HRC fuse links
Page 84, Table A.4.5.3:	Power that can be absorbed by D fuse bases
Page 85 Table A.4.5.4:	Maximum values of the rated currents and power dissipation of LV HRC fuse links

Comprehensive support

We can provide all the support you require, whether you have questions about our products, planning your electrical systems, or obtaining technical documents.

Get in touch:

Tel.: +49 (0) 180 50 50 222 (0,14 €/minute in the German telephone network)

Fax: +49 (0) 180 50 50 223

E-Mail: ad.support@siemens.com

Network installation technology

You can visit our website on the Internet, which contains all the information you need about our products: ALPHA distribution boards and terminal blocks, BETA circuit protection, GAMMA building management systems, and DELTA switches and power sockets:

<http://www.siemens.de/installationstechnik>

For information about new products, visit:

<http://www.siemens.de/beta-news>

The latest version of the BETA low-voltage controls and distribution catalog, with all current novelties, is available at

<http://www.siemens.de/beta/produkte>

Siemens AG
Industry Sector
Building Technologies
Division
P.O. Box 10 09 53
93009 REGENSBURG
GERMANY

The information provided in this brochure contains only general descriptions or characteristics of performance which in case of actual use do not always apply as described or which may change as a result of further development of the products. An obligation to provide the respective characteristics shall only exist if expressly agreed in the terms of the contract.

All product designations may be trade marks or product names of Siemens AG or another supplier company which may violate the owner's rights if used by third parties for their own purposes.

Subject to change 03/10 • Order No.: E10003-E38-10T-G3021-7600
DISPO 18301 • 0310 9.0
© Siemens AG 2010 • Printed in Germany