

REMOTE RESET MODULE, ELECTRICAL AC/DC
24...30 V FOR 3RU SIZE S00...S12



Figure similar





General technical data:		
product brand name		SIRIUS
Product designation		Electrical RESET
Design of the product		Electrical remote reset
Size of overload relay		S00, S0, S2, S3
Ambient temperature		
• during storage	°C	-50 ... +80
• during operation	°C	-20 ... +70
Control circuit/ Control:		
Type of voltage of the control supply voltage		AC/DC
Control supply voltage frequency		
• 1 Rated value	Hz	50
• 2 Rated value	Hz	60
Control supply voltage 1		
• at DC		
— Initial rated value	V	24
— Final rated value	V	30
• at AC		

— at 50 Hz Initial rated value	V	24
— at 50 Hz Final rated value	V	30
— at 60 Hz Final rated value	V	30
— at 60 Hz Initial rated value	V	24

Connections/ Terminals:

Type of electrical connection for auxiliary and control current circuit		screw-type terminals
Type of connectable conductor cross-section for auxiliary contacts		2x (0.5 ... 1.5 mm ²), 2x (0.75 ... 2.5 mm ²)
<ul style="list-style-type: none"> • solid • finely stranded — with core end processing 		2x (0.5 ... 1.5 mm ²), 2x (0.75 ... 2.5 mm ²)

Certificates/ approvals:

General Product Approval	Declaration of Conformity	Test Certificates
 CSA  EAC  UL	 EG-Konf.	spezielle Prüfbescheinigung n Typprüfbescheinigung/Werkszeugnis

Shipping Approval



other

[Umweltbestätigung](#)

Further information

Information- and Downloadcenter (Catalogs, Brochures,...)

<http://www.siemens.com/industrial-controls/catalogs>

Industry Mall (Online ordering system)

<http://www.siemens.com/industrymall>

Cax online generator

<http://support.automation.siemens.com/WW/CAXorder/default.aspx?lang=en&mlfb=3RU19002AB71>

Service&Support (Manuals, Certificates, Characteristics, FAQs,...)

<https://support.industry.siemens.com/cs/ww/en/ps/3RU19002AB71>

Image database (product images, 2D dimension drawings, 3D models, device circuit diagrams, EPLAN macros, ...)

http://www.automation.siemens.com/bilddb/cax_de.aspx?mlfb=3RU19002AB71&lang=en

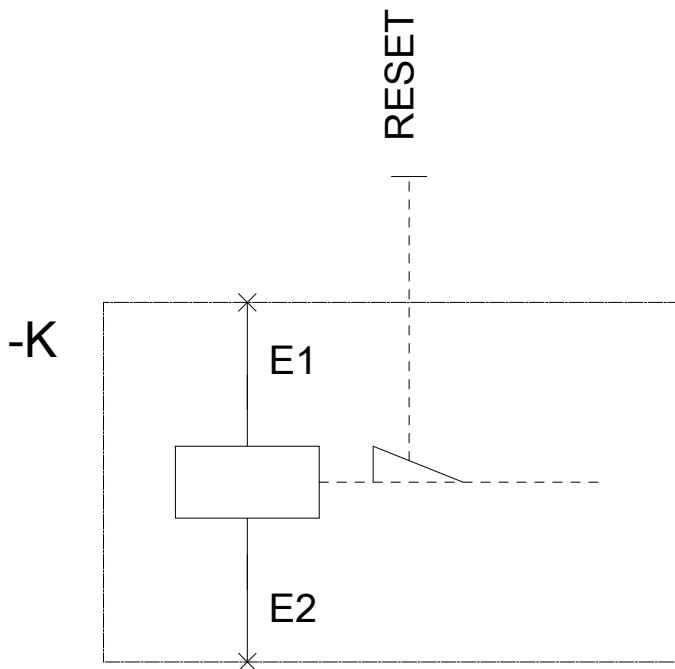
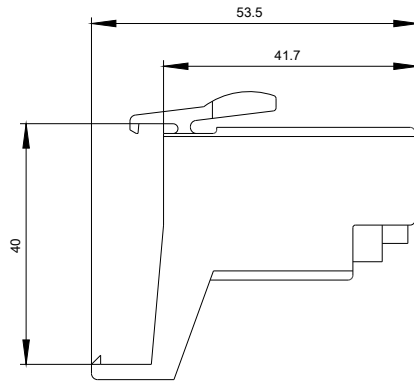
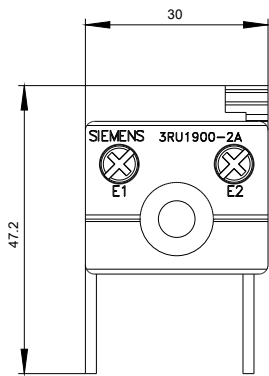

last modified:

17.07.2015