

decora plus™  
**Screwless  
 Wallplates**

For Decora Plus™  
 and Decora®  
 Wiring Devices



80301, 80309, 80311

**APPLICATION:**

For use in all branch circuits in commercial, industrial and institutional installations to cover Decora Plus and Decora wiring devices in outlet and/or switch boxes in compliance with the NEC® and other regulatory codes.

**FEATURES AND BENEFITS:**

- Screwless, snap-on design for contemporary architectural styling
- Complete kit includes screwless snap-on wallplate and mounting bracket
- Constructed of durable polycarbonate to withstand abuse
- Subplate offers ease of installation – exclusive “Hook n’ Snap” feature provides an easy, convenient wallplate installation
- Smooth face and rounded edges resist dust accumulation
- Accent any wall covering with wide selection of colors
- High dielectric strength and arc resistance, meeting or exceeding UL Standard 514
- Meets material test standards of NEMA WD-1, ANSI and Federal Specifications W-P-544. (Designer-configuration wallplates are not called for on Federal Specifications.)
- UL Listed, CSA Certified
- Backed by Leviton’s Limited Ten-Year Warranty

**TYPICAL SPECIFICATION:**

Leviton Decora Plus Screwless Wallplates are designed to cover Decora Plus and Decora wiring devices in applications where a screwless, architectural appearance is desired. Commercial Specification Grade Decora Plus wallplates are UL Listed, CSA Certified and meet NEMA standards WD-1. Two piece Decora Plus wallplate and mounting assembly feature polycarbonate construction and is backed by Leviton’s Limited Ten-Year Warranty.

Decora Plus™ Screwless Wallplates

**Leviton Mfg. Co., Inc.**

201 North Service Road, Melville, NY 11747 Tech Line: 1-800-824-3005 Fax: 1-800-832-9538 www.leviton.com  
 © 2012 Leviton Manufacturing Co., Inc. All rights reserved. Subject to change without notice.

### TESTING AND CODE COMPLIANCE:

All wallplates are listed by Underwriters Laboratories, Inc. (UL), CSA Certified and meet test requirements of Federal Specification W-P-455a, with the exception of cutout configurations, since the latest Federal Specifications do not yet call for designer styling of wallplates.





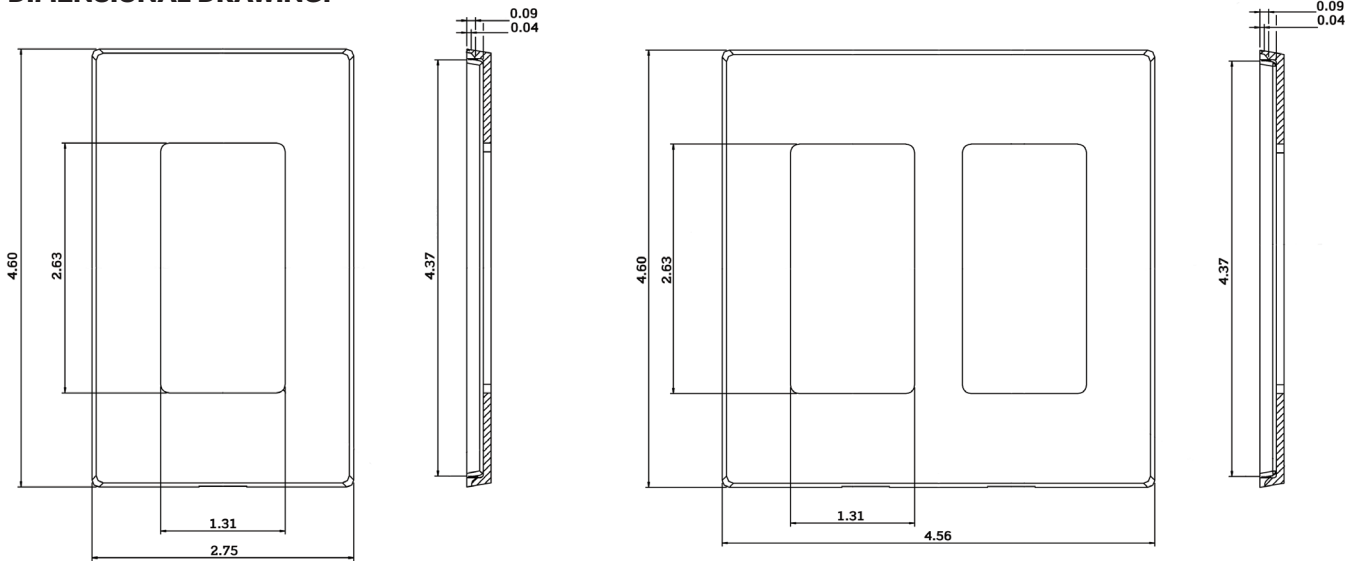

Typical tests include (in part) selection of materials used (polycarbonate), mechanical strength and fire resistance (five 15 second applications of a gas flame to plastic materials).

These wallplates are suitable for use in accordance with state, country, municipal and local codes, including ANSI/NFPA 2011 National Electrical Code and the OSHA Code.

### DIMENSIONAL DRAWING:



### ORDERING INFORMATION:

Description	White	Ivory	Light Almond	Gray	Black	Brown
1-gang 	80301-SW	80301-SI	80301-ST	80301-SGY	80301-SE	80301-S
2-gang 	80309-SW	80309-SI	80309-ST	80309-SGY	80309-SE	80309-S
3-gang 	80311-SW	80311-SI	80311-ST	—	80311-SE	80311-S
4-gang 	80312-SW	80312-SI	80312-ST	—	80312-SE	80312-S
5-gang 	80321-SW	80321-SI	80321-ST	—	—	—
6-gang 	80326-SW	80326-SI	80326-ST	—	—	—

#### Leviton Manufacturing Co., Inc.

201 North Service Road, Melville, NY 11747-3138  
 Telephone: 1-800-323-8920 • Fax: 1-800-832-9538 • Tech Line: (8:30AM-7:00PM E.T. Monday-Friday): 1-800-824-3005

#### Leviton Manufacturing of Canada, Ltd.

165 Hymus Boulevard, Pointe Claire, Quebec H9R 1E9 • Telephone: 1-800-469-7890 • Fax: 1-800-563-1853

#### Leviton S. de R.L. de C.V.

Lago Tana 43, Mexico DF, Mexico CP 11290 • Tel. (+52) 55-5082-1040 • Fax. (+52) 5386-1797 • www.leviton.com.mx

Visit our website at [www.leviton.com](http://www.leviton.com)

© 2012 Leviton Manufacturing Co., Inc. All rights reserved. Subject to change without notice.



G-8876/H12-dp