

Hubbell Fire-Rated Poke-Throughs Featuring Hubbell SystemOne FRPTs

HUBBELL



SystemOne 4x4



SystemOne Multimedia



SystemOne Furniture Feed



Traditional 2x2



Nobody delivers like Hubbell Commercial Solutions



Wiring Systems

Hubbell Fire-Rated Poke-Throughs

Featuring the innovative capabilities of Hubbell's SystemOne Delivery System line, Hubbell has expanded its offering of Fire-Rated Poke-Through (FRPT) products, making it the most extensive in the industry. Hubbell SystemOne FRPTs install in a 4" core hole and provide users the flexibility to create personal solutions for their most demanding applications.

For those requiring a 3" diameter FRPT, Hubbell continues to provide a wide variety of traditional solutions for flush, pedestal and furniture feed applications. All Hubbell FRPT products include a "step-down" feature, enabling wiring, installation and if necessary, removal from the floor above.

Whatever combination of power, data and audio/video connections are required, Hubbell provides the answer; bringing consistent, aesthetic and functional solutions to the desktop.



Hubbell SystemOne FRPTs for 4" diameter applications...



Multi-Service Applications

This Hubbell SystemOne sub-plate incorporates 2 Style Line® rectangular openings. These can be used for a variety of power and/or data applications. It will accommodate 15 or 20 amp, standard, isolated ground, GFCI or surge protected duplex receptacles. Using communication frames it can provide up to a 6-port multi-service or a 12-port all communication solution.



Multimedia Applications

Other Hubbell SystemOne sub-plates are designed to meet the growing needs of the audio and video markets. Some sub-plates provide power outlets with Hubbell's audio/video products including 15-Pin SVGA, RCA, S-Video, 3.5mm stereo, and XLR microphone jacks. Another sub-plate can accommodate Extron® Electronics's MAAP and AAP series audio/video modules.



4X4 Applications

Provides maximum power capacity for flush, multi-service applications. This sub-plate features a pre-wired four outlet 20A, 125V receptacle and four openings for snap-in flush mount Hubbell modular jacks and audio/video snap-in connectors.

Advantage ^{HUBBELL}

- Best in Class Products**
Easily upgraded as user's needs change.
- Ease of Installation**
Clips allow installation and removal from above the floor.
- Application Solutions**
Highest capacity and widest variety of power, data and AV solutions.

Traditional FRPTs for 3" and 2" diameter applications...



Flush Applications

Hubbell offers a variety of single and multi-service flush fire-rated poke-through products. It incorporates a Hubbell Style Line[®], 20 amp, duplex receptacle and two Hubbell Category 5e data jacks. The jacks mount flush to the cover for an unobtrusive appearance. Various colors and all brass versions are available.



Pedestal Applications

Hubbell offers single and multi-service pedestal style FRPTs for those applications requiring above-the-floor connections. Available in 2, 4 or 6 gang sizes, pedestal FRPTs provide additional power and low voltage connections to the desktop than most flush configurations in a 3" core hole.



Furniture Feed Applications

Hubbell offers single and multiple service flush and pedestal style FRPTs that deliver power and voice/data cabling to feed furniture systems. Various models can feed up to 2" conduit and can accommodate up to 36 Category 5e data cables.

Hubbell SystemOne Through-Floor Fitting



Step down installation clips allow the fitting to be installed or removed from the floor above.

Barrier expands during fire conditions to maintain the floor's fire rating.

Adjustable lower fire barrier accommodates concrete floor thicknesses from 2 1/4" to 7".

Features dual 1" EMT conduit tubes for increased cable capacity.

- Accepts all Hubbell SystemOne covers and sub-plates (4X4 FRPT system uses a separate FRPT and sub-plate).
- Excellent solution for both retrofit and new construction.
- Brings power, voice, data and multimedia precisely where needed.
- Installs in 4" core hole.
- UL listed for use in 1-4 hr fire rated floors.

Hubbell SystemOne Universal Cover

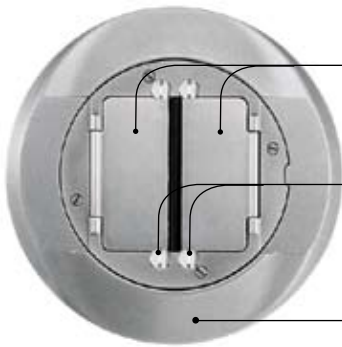

Hinged doors open 180 degrees flush to the carpet flange or tile.

Screws allow each door to be secured independently.

Universal carpet or tile flange can be used for Hubbell SystemOne Fire-Rated Poke-Through or PVC Floor Box.

- Cast aluminum construction available in durable black, gray, brass, aluminum and ivory powder coat finishes.
- Features ScrubShield™ technology that exceeds UL514A and UL514C scrub water exclusion requirements.
- Provides consistent look and maximum functionality throughout.

Hubbell SystemOne Sub-plates

While no one can predict the future, Hubbell's modular sub-plate design allows users to economically upgrade Hubbell SystemOne FRPTs to accommodate future moves, adds and changes.



- Hubbell 4X4 – four 20A, 125V receptacles and four openings for voice/data jacks and multimedia connectors.
- Hubbell INFINESTATION™ front loading modular connectivity.
- Accommodates Extron Electronic's Architectural Series™ audio/video system integration products.
- Ortronics®, Siemon™, Panduit®, SYSTIMAX® and keystone options enable maximum data flexibility.
- Large capacity and multi-service furniture feed applications.
- GFCI, surge and standard Style Line receptacles.
- Twist-Lock® receptacle with or without data jacks.

Hubbell SystemOne FRPT 4" Diameter – One Piece Units

Catalog Number			Catalog Number			Catalog Number		
S1PTBRS	Brass	Dual Style Line Poke-Through	S1PT3IMBRS	Brass	Modular A/V Poke-Through	S1PT4X4BRS	Brass	4X4 Poke-Through
S1PTAL	Aluminum		S1PT3IMAL	Aluminum		S1PT4X4AL	Aluminum	
S1PTBL	Black		S1PT3IMBL	Black		S1PT4X4BL	Black	
S1PTGY	Gray		S1PT3IMGY	Gray		S1PT4X4GY	Gray	
Complete assembled unit			Complete assembled unit			Complete assembled unit		
■ S1PTFIT floor fitting		■ S1PTFIT floor fitting		■ S1PT4X4FIT floor fitting				
■ S1SP sub-plate		■ S1SP3IM sub-plate		■ S1SP4X4 sub-plate				
■ Universal carpet cover		■ Universal carpet cover		■ Universal carpet cover				

Hubbell SystemOne FRPT 4" Diameter – Three Piece Units

Through Floor Fittings

Catalog Number		Catalog Number	
S1PTFIT	Dual Channel Through Floor Fitting	S1PT4X4FIT	4X4 Through Floor Fitting
Through floor fitting with (2) 1" trade size conduit stems to feed power and communication services. For use with Hubbell SystemOne Universal Covers and all sub-plates except S1SP4X4, S1SP4X4PA, S1SP4X4SYS and S1SPTL.		Through floor fitting with (2) 3/4" conduit stubs for communications and (1) 3/4" conduit stem for power. For use with Hubbell SystemOne Universal Covers and S1SP4X4, S1SP4X4PA, S1SP4X4SYS and S1SPTL sub-plates only.	

Universal Covers

Universal, Cast Aluminum Carpet Flange & Cover Assembly

Catalog Number	
S1CFCBRS	Brass
S1CFCAL	Aluminum
S1CFCBL	Black
S1CFCGY	Gray
S1CFCI	Ivory

■ Cast aluminum construction
■ Powder coat finish

Universal, Cast Aluminum Tile Flange & Cover Assembly

Catalog Number	
S1TFCBRS	Brass
S1TFCAL	Aluminum
S1TFCBL	Black
S1TFCGY	Gray
S1TFCI	Ivory

■ Cast aluminum construction
■ Powder coat finish

Sub-plates

Catalog Number		Catalog Number		Catalog Number	
S1SP	Style Line/GFCI (2) Style Line® openings for power and/or datacom applications.	S1SP4X4*	Hubbell 4 X 4 (4) 20A, 125V receptacles. (4) Keystone openings for Hubbell jacks or flush A/V connectors.	S1SPTL*	Twist-Lock® + Data 20 or 30 Amp TL rec. (1.56" OD). (2) Keystone openings for Hubbell jacks or flush A/V connectors.
S1SP4IM	Hubbell Datacom 1 unit flush INFIneSTATION™ opening. 3 unit recessed INFIneSTATION opening for data, voice, and A/V applications. (See Page 11 for details)	S1SP3IM	Hubbell A/V + Power (1) 20A, 125V receptacle. 3 unit recessed INFIneSTATION opening for data, voice, and A/V applications. (See Page 11 for details)	S1SPFFBRS	Brass Furniture
S1SPEXT1	Extron® MAAP + Power (1) 20A, 125V receptacle. Recessed opening for (3) single Extron® MAAP Series adapter plates.	S1SPEXT2	Extron AAP + Power (1) 20A, 125V receptacle. Recessed opening for (1) single Extron MAAP and (2) single AAP Series adapter plates.	S1SPFFAL	Alum. Feed Cover/Flange
S1SPORT	Ortronics Series II® + Power (1) 20A, 125V receptacle. Recessed opening for (3) 1 unit Ortronics® Series II modules.	S1SPTRAC	Ortronics TracJack® + Power (1) 20A, 125V receptacle. Recessed bezel for (6) Ortronics TracJack modules.	S1SPFFBL	Black Flange
S1SP4X4PA*	Panduit Mini-Com® 4 X 4 (4) 20A, 125V receptacles (4) Openings for Panduit Mini-Com Connectivity.	S1SP4X4SYS*	SYSTEMIMAX® 4 X 4 (4) 20A, 125V receptacles. (4) Openings for SYSTEMIMAX Connectivity.	S1SPFFGY	Gray (1) 3/4" & (1) 1 1/2" KOs for power and/or datacom applications. Universal Cover not required. Includes carpet flange.
				S1SPEXT3	Extron Datacom Recessed opening for (2) single Extron MAAP and (2) single AAP Series adapter plates.
				S1SPMAX	Simon Max® + Power (1) 20A, 125V receptacle. Recessed bezel for (6) Simon Max modules.

* Note: S1SP4X4, S1SP4X4PA, S1SP4X4SYS and S1SPTL are for use with S1PT4X4FIT fitting only.

2X2 Flush FRPT 3" Diameter – One Piece Units

Catalog Number

PT2X2BL	Black	2X2 Aluminum Poke-Through
PT2X2GY	Gray	
PT2X2IGBL*	Black	
PT2X2IGGY*	Gray	

* Includes pre-wired 20A isolated ground duplex Style Line receptacle.

Complete assembled unit

- PT2X2FIT through-floor fitting.
- Pre-wired 20A duplex Style Line® receptacle & (2) Category 5e data jacks.
- Non-metallic cover.
- Painted aluminum flange.



Catalog Number

PT2X2BRS3	Black/Brass	2X2 Brass Poke-Through
PT2X2BRS	Brass Finish/Brass	
PT2X2IGBRS3*	Black/Brass	
PT2X2IGBRS*	Brass Finish/Brass	

* Includes pre-wired 20A isolated ground duplex Style Line receptacle.

Complete assembled unit

- PT2X2FIT through-floor fitting.
- Pre-wired 20A duplex Style Line receptacle & (2) Category 5e data jacks.
- Non-metallic cover.
- Solid brass flange.



2X2 Flush FRPT 3" Diameter – Two Piece Units

Through-Floor Fitting

Catalog Number

PT2X2FIT

Multi-Channel Through-Floor Fitting

Through-floor fitting with (1) ¼" trade size conduit stem with junction box for power and (2) ½" low voltage conduit entrances.



Specifications:

- UL Listed and CSA Certified.
- 1- 4 hour fire rating (1-3 hour for steel floor units and concrete topping (D900 Series Design)).
- For 2 ¼" to 7" floor thickness.
- UL installation spacing. Minimum 2 ft. on center and not more than one per 65 sq. ft. of floor area.

Service Fittings

Catalog Number

PT2X2SFBL	Black	2X2 Aluminum Service Fitting
PT2X2SFGY	Gray	

- Pre-wired 20A duplex Style Line receptacle & (2) Category 5e data jacks.
- Non-metallic cover.
- Painted aluminum flange.



Catalog Number

PT2X2SFBR3	Black/Brass	2X2 Brass Service Fitting
PT2X2SFBR	Brass Finish/Brass	

- Pre-wired 20A duplex Style Line receptacle & (2) Category 5e data jacks.
- Non-metallic cover.
- Solid brass flange.



Accessories

Catalog Number

PT2X2CBL	Black	Non-Metallic Replacement Covers
PT2X2CGY	Gray	
PT2X2CBRS	Brass Finish	



Flush Duplex FRPT 3" Diameter – One Piece Units



Catalog Number			Catalog Number			
PT7FSDBLA	Black	Flush Aluminum Poke-Through 	PT7FSDBRS2A	All Brass	Flush Brass Poke-Through 	
PT7FSDGYA	Gray		PT7FSDBRS3A	Black/Brass		
PT7FSDIA	Ivory		PT7IGFSDBRSA*	All Brass		
PT7FSDBRA	Brown		* Includes pre-wired 20A isolated ground duplex receptacle.			
PT7IGFSDGYA*	Gray		Complete assembled unit <ul style="list-style-type: none"> ■ PT7FSD through-floor fitting. ■ Pre-wired 20A duplex receptacle. ■ Non-metallic flip lid cover with (2) 1/2" diameter low voltage feed through holes. ■ Painted aluminum flange. 			
PT7IGFSDIA*	Ivory		Complete assembled unit <ul style="list-style-type: none"> ■ PT7FSD through-floor fitting. ■ Pre-wired 20A duplex receptacle. ■ All brass or black non-metallic cover option. ■ Flip lid cover with (2) 1/2" diameter low voltage feed through holes. ■ Solid brass flange. 			

Flush FRPT 3" Diameter – Two Piece Units



Through-Floor Fitting

Catalog Number			
PT7FSD (with Junction Box)		Multi-Channel Through Floor Fitting 	Specifications: <ul style="list-style-type: none"> ■ UL Listed and CSA Certified. ■ 1- 4 hour fire rating (1-3 hour for steel floor units and concrete topping, D900 Series Design). ■ For 2 1/4" to 7" floor thickness. ■ UL installation spacing. Minimum 2 ft. on center and not more than 1 per 65 sq. ft. of floor area.
PT73SD (without Junction Box)			
Through-floor fitting with (1) 3/4" trade size conduit stem for power and (2) 1/2" low voltage feed through holes.			



Service Fittings

Catalog Number			Catalog Number		
FRFBLA	Black	Flush Aluminum Service Fitting 	FRFBRS2A	Solid Brass	Flush Brass Service Fitting 
FRFGYA	Gray		<ul style="list-style-type: none"> ■ Pre-wired 20A duplex receptacle. ■ Solid brass flip lid cover with (2) 1/2" diameter low voltage feed-through holes. ■ Solid brass flange. 		
FRFIA	Ivory				
FRFBRA	Brown				



Accessories

Catalog Number			Catalog Number		
PFBRCLBLA	Black	Non-Metallic Replacement Covers 	BRS2RCA	Solid Brass	All Brass Replacement Covers 
PFBRCBGYA	Gray				
PFBRCLIA	Ivory				
PFBRCLBRA	Brown				

Large Capacity, Low Voltage Flush Furniture Feed FRPT 3" Diameter – Two Piece Units



Catalog Number		Catalog Number		
PT2FIT	Large Capacity, Low Voltage Through Floor Fitting	FF2BRS	Brass Finish	Large Capacity Cover/Flange
		FF2BK	Black	
		FF2GY	Gray	
<p>Through floor fitting with (1) 2" trade size conduit stem. Will accommodate up to 36 Category 5e cables.</p> <p>Specifications:</p> <ul style="list-style-type: none"> ■ UL Listed and CSA Certified. ■ 1-2 hour fire rating. ■ For 2 ¼" to 7" floor thickness. ■ UL installation spacing. Minimum 2 ft on center and not more than 1 per 65 sq. ft. of floor area. 		<ul style="list-style-type: none"> ■ Cover/flange with 1 ¼" & 2" combination knockout. ■ Painted aluminum cover and flange. 		
				

Flush Furniture Feed FRPT 3" Diameter – One Piece Units



Catalog Number		Catalog Number		
PT73FFSDGY	Gray	PT7FFSDGY	Gray	Single Service Furniture Feed Poke-Through
PT73FFSDI	Ivory	PT7FFSDI	Ivory	
<p>3 Service Furniture Feed Poke-Through</p> <p>Complete assembled unit</p> <ul style="list-style-type: none"> ■ PT73SD floor fitting. ■ Aluminum cover with (2) ½" threaded hubs for low voltage and (1) ¾" threaded hub for power. ■ Painted aluminum flange. 		<p>Single Service Furniture Feed Poke-Through</p> <p>Complete assembled unit</p> <ul style="list-style-type: none"> ■ PT71SD floor fitting. ■ Aluminum cover with (1) KO to accept a ¾" connector. ■ Painted aluminum flange. 		
				

Flush Furniture Feed FRPT 3" Diameter – Two Piece Units

Through-Floor Fittings

Catalog Number		Catalog Number		
PT73SD	3 Service Furniture Feed Through-Floor Fitting	PT71SD	Single Service Furniture Feed Through-Floor Fitting	
<p>Through-floor fitting with (1) ¾" trade size conduit stem for power and (2) ½" low voltage conduit holes.</p> <p>Specifications:</p> <ul style="list-style-type: none"> ■ UL Listed and CSA Certified. ■ 1- 4 hour fire rating (1-3 hour for steel floor units and concrete topping, D900 Series Design). 		<p>Through-floor fitting with (1) ¾" trade size conduit stem for power or low voltage applications.</p> <ul style="list-style-type: none"> ■ For 2 ¼" to 7" floor thickness. ■ UL installation spacing. Minimum 2 ft. on center and not more than 1 per 65 sq. ft. of floor area. 		
				

Service Fittings

Catalog Number		Catalog Number		
FRF3BK	Black	FRF1BK	Black	Single Service Furniture Feed Service Fitting
FRF3GY	Gray	FRF1GY	Gray	
FRF3I	Ivory	FRF1BRS	Brass Finish	
<p>3 Service Furniture Feed Service Fitting</p> <ul style="list-style-type: none"> ■ Aluminum cover with (2) ½" threaded hubs for low voltage and (1) ¾" threaded hub for power. ■ Painted aluminum flange. 		<ul style="list-style-type: none"> ■ Aluminum cover with (1) KO to accept a ¾" connector. ■ Painted aluminum flange. 		
				

Painted Pedestal FRPT 3" Diameter – Two Piece Unit

Through-Floor Fitting

Catalog Number

PT7XC

Large Capacity Multi-Service Pedestal Through Floor Fitting

Through floor fitting with (1) 1 ¼" trade size conduit stem for low voltage and (1) ½" trade size conduit stem for power applications.

Specifications:

- UL Listed and CSA Certified.
- 1- 4 hour fire rating (1-3 hour for steel floor units and concrete topping, D900 Series Design).
- For 2 ¼" to 7" floor thickness.
- UL installation spacing. Minimum 2 ft. on center and not more than 1 per 65 sq. ft. of floor area.



Painted Pedestal FRPT 2" Diameter – Two Piece Unit

Through-Floor Fitting

Catalog Number

PT27A

Multi-Service Pedestal Through Floor Fitting

Through floor fitting with (1) ¾" trade size conduit stem for low voltage and (1) ½" trade size conduit stem for power applications.

Specifications:

- UL Listed and CSA Certified.
- 1- 4 hour fire rating (1-3 hour for steel floor units and concrete topping, D900 Series Design).
- For 2 ¼" to 7" floor thickness.
- UL installation spacing. Minimum 2 ft. on center and not more than 1 per 65 sq. ft. of floor area.



Pedestal Service Fittings (Order 1 plate per gang)

Catalog Number

FR280BKA Black **2-Gang**
FR280GYA Gray

Use with PT27A only.

Catalog Number

FR480BKA Black **4-Gang**
FR480GYA Gray

Use with PT27A or PT7XC.

Catalog Number

FR680BKA Black **6-Gang**
FR680GYA Gray

Use with PT27A or PT7XC.



- Painted aluminum housing with low voltage barrier(s). Plates and devices sold separately.
- For additional barriers, use catalog number FRBR1 (see page 10).

Pedestal Face Plates (Order 1 plate per gang)

Catalog Number

SS2309DBKA Black **Duplex**
SS2309DGYA Gray



SS2309SLBKA Black **Style Line/**
SS2309SLGYA Gray **GFCI**



SS2309SBKA Black **Single Rec.**
SS2309SGYA Gray **(1.39" OD)**



SS2309BBKA Black **Blank**
SS2309BGYA Gray

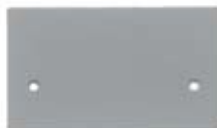

Catalog Number

SS2309FBKA Black **Furniture Feed**
SS2309FGYA Gray **(¾" KO)**



SS2309F1BKA Black **Furniture Feed**
SS2309F1GYA Gray **(1" KO)**



SS2309TBKA Black **Bushed Data**
SS2309TGYA Gray **Opening (1" ID)**



- Painted aluminum plates.

Brushed Aluminum Pedestal FRPT 3" Diameter - Two Piece Unit

Through-Floor Fitting

Catalog Number

PT7XC

Large Capacity Multi-Service Pedestal Through-Floor Fitting

Through floor fitting with (1) 1 1/4" trade size conduit stem for low voltage and (1) 1/2" trade size conduit stem for power applications.

Specifications:

- UL Listed and CSA Certified.
- 1- 4 hour fire rating (1-3 hour for steel floor units and concrete topping, D900 Series Design).
- For 2 1/4" to 7" floor thickness.
- UL installation spacing. Minimum 2 ft. on center and not more than 1 per 65 sq. ft. of floor area.



Pedestal Service Fitting

Catalog Number

FR80AL Brushed Aluminum

2-Gang Pedestal Service Fitting

For use with PT7XC only.

- Brushed aluminum housing with low voltage barrier. Plates and devices sold separately.



Plates

Catalog Number

SS309D Duplex



SS309S Single Rec. (1.39" OD)



SS309B Blank



SS309DS Style Line/GFCI



Catalog Number

SS309T Bushed Data Opening (1" ID)



SS309SF* Furniture Feed (3/4" KO)



SS309BF* Furniture Feed Blank



* For furniture feed applications using SS309SF, a SS309BF blank must be used for 2nd plate.

- 302/304 Stainless steel plates (SS309SF & SS309BF are aluminum).

3" Diameter FRPT Accessories

Catalog Number

FRP250 Gray **Closure Plug**

Textured aluminum plug seals 3" core hole when FRPT is no longer required and is removed. Maintains the floor's 1- 4 hour fire rating.



AP2GY Gray **Flush FRPT**
AP2I Ivory **Abandonment Plate**

Use with PT7FSD, PT73SD or PT71SD only. Covers the opening when FRPT is abandoned. Service fitting is removed and through-floor fitting remains.



FF3GY Gray **Multi-Service Furniture Feed**
FF3I Ivory **Replacement Inserts**

Use as a replacement cover for PT73FFSD series, or to convert installed PT7FSD series into furniture feed FRPTs. Includes (2) 1/2" threaded hubs for low voltage and (1) 3/4" threaded hub for power. (UL listed only.)



Catalog Number

EXT13 **PT7XC Extension Kit**

Extends PT7XC FRPT to accommodate between 7" and 13" floor thickness.



AP22 2-Gang Gray **Pedestal FRPT**
AP42 4-Gang Gray **Abandonment Plate**

Use with PT27A or PT7XC Only. Covers the opening when FRPT is abandoned. Service fitting is removed and through-floor fitting remains.



FRBR1 **Low Voltage Barrier**

Use with FR280, FR480, and FR680 pedestal service fittings only when additional power/low voltage separation is required.



Power, Data, Audio and Video Accessories

Modular Jacks	Multimedia Connectors	INFINESTATION® Modules (Office White)	Outlet Frames	Wiring Devices
HBL6OW* Category 6 Universal Wired Office White	SIFOW** F-Type F/F Coupler Office White	DFBM05OW Blank .5 Unit	Outlet Frames FCX244OW++ 2-Port Style Line® Frame Office White	Wiring Devices HBL2152 +++ 15A 125V Style Line Duplex Receptacle Brown
HBL5EOW* Category 5e Universal Wired Office White	SIFGOW** Gold F-Type F/F Coupler Office White	DFBM1OW Blank 1 Unit	FCX344OW++ 3-Port Style Line Frame Office White	HBL2162 +++ 20A 125V Style Line Duplex Receptacle Brown
HBLUOW* USOC 6-Position Office White	SIRCAxx*** RCA 110 Punch Down Black	DFBM15OW Blank 1.5 Unit	FCX444OW++ 4-Port Style Line Frame Office White	HBL2310 20A 125V Twist-Lock Receptacle (1.56" boss diameter) Black
SIBOWPK10** Blank Module Office White	SIRCAFFxx + Gold RCA F/F Coupler Pass-Thru Office White	DF1KOW 1-Port Keystone Flat 1 Unit	FCX444OW++ 4-Port Style Line Frame Office White	HBL2320 20A 250V Twist-Lock Receptacle (1.56" boss diameter) Black
* Office White is standard color. For other colors, replace 'OW' as follows: BK = Black B = Blue EI = Electric Ivory GY = Gray GN = Green OR = Orange R = Red TI = Telco Ivory W = White Y = Yellow.	SIRCASxx + RCA Solder Coupler Office White	DF2KOW 2-Port Keystone Flat 1 Unit	FCX644OW++ 6-Port Style Line Frame Office White	HBL2610 30A 125V Twist-Lock Receptacle (1.56" boss diameter) Black
** Office White is standard color. For other colors, replace 'OW' as follows: GY = Gray I = Ivory W = White.	SISVFFBK S-Video F/F Coupler Black	DFA1KOW 1-Port Keystone Angled 1 Unit	DJOOW++ 2-Port 106 Duplex Frame Office White	HBL2620 30A 250V Twist-Lock Receptacle (1.56" boss diameter) Black
***Housing color is Black. Replace 'xx' with one of the following to designate insulator color: OW = Red W = White Y = Yellow	SISVOW S-Video 110 Coupler Black	DFA2KOW 2-Port Keystone Angled 1 Unit	DJ106OW++ 4-Port 106 Duplex Frame Office White	Extron is a registered trademark of Extron Electronics. MAX and CT Series are registered trademarks of The Siemon Company. Mini-Command Panduit are registered trademarks of Panduit Corp. SYSTIMAX is a registered trademark of CommScope, Inc. TracJack, Series II and Ortronics are registered trademarks of Ortronics/Legrand.
+ Housing color is Black. Replace 'xx' with one of the following to designate insulator color: R = Red W = White Y = Yellow BK = Black	SIBNCOW** BNC Coupler Office White	DFA1SCOW 1 SC Duplex Angled 1.5 Unit		
++ Office White is standard color. For other colors, replace 'OW' as follows: GY = Gray I = Ivory W = White BK = Black	SIFSCOW SC Simplex Adapter Office White	DFA2SCOW 2 SC Duplex Angled 1.5 Unit		
+++ Standard color is Brown. For other colors, add one of the following to the end of the catalog number: I = Ivory GY = Gray WA = White BK = Black OW = Office White	SISTOW** ST-Style Adapter Office White	DFRA1KOW 1-Port Keystone Recessed 1.5 Unit		
		DFRA2KOW 2-Port Keystone Recessed 1.5 Unit		
		DF115FFOW 15-Pin SVGA F/F, 1 Unit		
		DF19FFOW 9-Pin F/F 1 Unit		
		DF115SOW 15-Pin SVGA Screw Terminal 1 Unit		

Nobody delivers like Hubbell Commercial Solutions

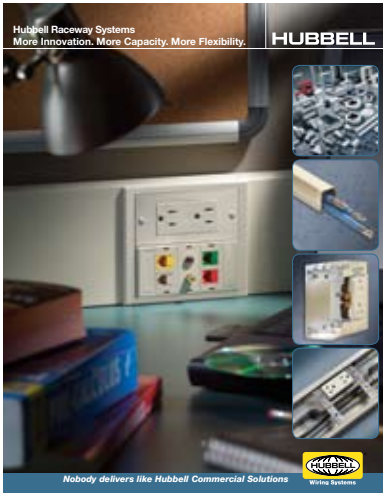

Hubbell expands its line of Raceway to include a complete offering of steel, aluminum and non-metallic systems.



Hubbell SystemOne. The only Floor Box and FRPT system that uses common covers for a seamless look.



Hubbell provides a full offering of Floor Box products including large capacity and Hubbell SystemOne options.

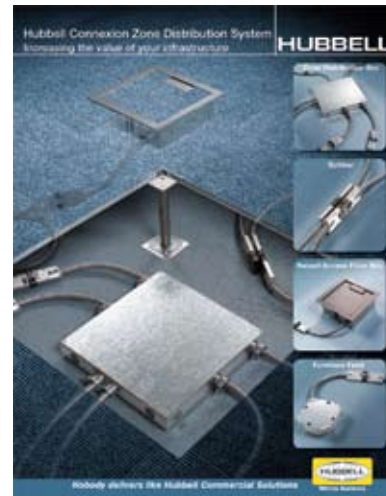

Hubbell offers a line of raised access, zone distribution products for commercial environments.



The GFCI that tests itself! You may forget, but Hubbell's AutoGuard GFCI won't.



Hubbell's full line catalog provides the widest variety of industrial and commercial products available.