

Section V

tradeSELECT®

netSELECT®

tradeSELECT®	Page
Decorator Products	
Advantages	V-2
Decorator Quiet Rocker Switches	V-3
Combination Quiet Rocker Switches/Devices	V-4
Weather Resistant, Tamper-Resistant and Standard Receptacles	V-5
Snap-On, Nylon and Metal Wallplates	V-6
Combination Wallplates	V-7
Decorator Frames	V-8
Modular Snap Fit Jacks	V-9
Molded-In Voice/Data/Video	V-10
Switches and Receptacles	
Toggle Switches and Combination Switches/Devices	V-11
Three and Four Way Toggle Switches	V-12
Combination Switches/Devices	V-13
Duplex Quick Thread Receptacles	V-14
Duplex and Single Receptacles	V-15
GFCI Receptacles	V-16
Range and Dryer Power Receptacles and Plugs	V-17
Special Use Products	V-18
Lighting Controls	
Dimmers and Fan Speed Controls	V-19
Toggle Dimmers and Fan Speed Controls	V-20
Occupancy and Vacancy Sensors	V-21
Power Delivery	
Floor Boxes for Wood Floors	V-22
Floor Boxes for Concrete Floors	V-24
Under Cabinet/Counter Power Distribution	V-26
JLOAD® Multimedia Outlet	V-27
Decorator Switches	V-28
netSELECT®	
V-29	
Structured Wiring	
In-Wall AV Delivery	V-30
HDMI Products	V-31
Advantages and Wiring Layout	V-32
Network Enclosures	V-33
Network Modules	V-34
Audio/Video Modules	V-35
Universal Consolidation Blocks, Patch Panels and Patch Cords	V-36
Accessories	V-37
Data Communications and Audio/Video	
Modular Snap Fit Jacks	V-38
Decorator Frames	V-39
Molded-In Voice/Data/Video	V-40
Molded-In Plates	V-41
Telephone Wall Jacks	V-42



tradeSELECT® Decorator Quiet Rocker Switches

Advantages

Smart Style, Good Looks.

Residential Decorator Switches and Receptacles provide more than solid, dependable function alone. Indeed, they are fashion statements, masterfully complementing the look and feel of any room in any home.

A PERFECT MATCH

Residential decorator devices and wallplates blend in beautifully with all kinds of wall coverings.

EASY-ACTIVATE ROCKERS

Ideal for use in assisted-living environments—or any living environment.



FLUSH AND CONTEMPORARY

Sleek, smart and appealing, Residential devices add beautiful, fashionable, highly-styled devices to any home.

MINI-ROCKER SWITCHES

Take up less space and provide full function.

SNAP-ON WALLPLATES

Snap-on wallplates offer a clean, elegant look that can be installed in seconds.



Color Selection



V-2



Wiring Device-Kellems

www.hubbell-wiring.com

Dimensions in Inches (mm)

tradeSELECT® Decorator Quiet Rocker Switches



Features

- Smooth, quiet rocker
- Self-grounding feature is standard
- Ultrasonically welded cover and base
- Operating temperature: -20°C to 60°C
- UL Listed E3896, CSA Certified

Single Pole Decorator Quiet Rocker Switches

Description	Single Pole	Single Pole, Illuminated*	Single Pole, Pilot Light**	Single Pole with ON/OFF Marking
Termination	Self-Grounding, Push, Back and Side Wire	Self-Grounding, Push, Back and Side Wire	Self-Grounding, Push, Back and Side Wire	Self-Grounding, Push, Back and Side Wire
Rating	15A 120-277V AC	15A 120V AC	15A 120V AC	15A 120-277V AC
Almond	RSD115AL	RSD115ILAL	RSD115PLAL	—
Black	RSD115BK	—	—	—
Brown	RSD115	—	—	—
Gray	RSD115GY	—	—	—
Ivory	RSD115I	RSD115ILI	RSD115PLI	RSD115IM
Light Almond	RSD115LA	RSD115ILLA	RSD115PLLA	RSD115LAM
White	RSD115W	RSD115ILW	RSD115PLW	RSD115WM

Note: * Light glows through the top portion of the rocker when switch is in the off position. Does not require a neutral wire.
 ** Light glows through the top portion of the rocker when switch is in the on position. Requires a neutral wire.



Double Pole, Three Way and Four Way Decorator Quiet Rocker Switches

Description	Double Pole	Three Way	Three Way, Illuminated*	Four Way
Termination	Self-Grounding, Back and Side Wire	Self-Grounding, Push, Back and Side Wire	Self-Grounding, Push, Back and Side Wire	Self-Grounding, Back and Side Wire
Rating	15A 120-277V AC	15A 120-277V AC	15A 120V AC	15A 120-277V AC
Almond	RSD215AL	RSD315AL	RSD315ILAL	RSD415AL
Black	RSD215BK	RSD315BK	—	RSD415BK
Brown	RSD215	RSD315	—	RSD415
Gray	RSD215GY	RSD315GY	—	RSD415GY
Ivory	RSD215I	RSD315I	RSD315ILI	RSD415I
Light Almond	RSD215LA	RSD315LA	RSD315ILLA	RSD415LA
White	RSD215W	RSD315W	RSD315ILW	RSD415W

Note: * Light glows through the top portion of the rocker when switch is in the off position. Does not require a neutral wire.



Product Dimensions

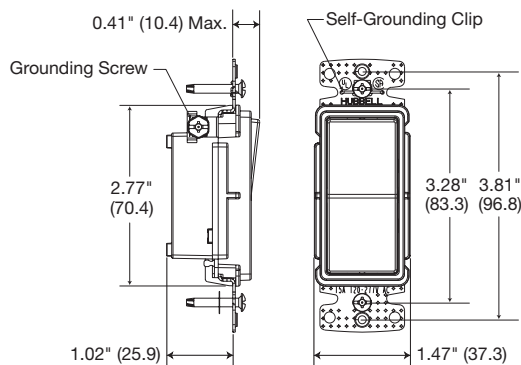

Single Pole Decorator Switch

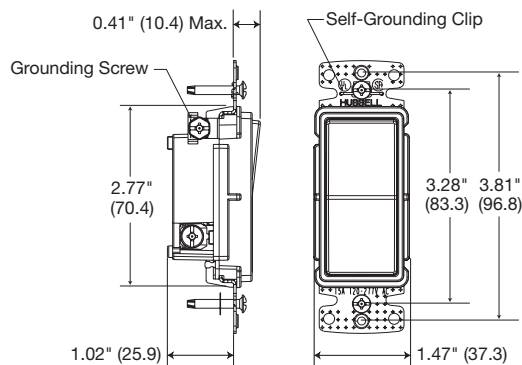

Three Way Decorator Switch



tradeSELECT® Combination Quiet Rocker Switches/Devices



Decorator Products

Features

- Low profile, less than 1 inch deep
- Self-grounding feature is standard
- Operating temperature: -20°C to 60°C
- UL Listed E3896, CSA Certified

Combination Quiet Rocker Switches/Devices



RCD111W

Description	Three (3) Single Pole Switches		Two (2) Single Pole Switches	Single Pole and Three Way Switch	 * Single Pole Switch, Tamper-Resistant*, 2 Pole, 3 Wire, Receptacle	Single Pole Switch, 2 Pole, 3 Wire Receptacle
	Termination	Self-Grounding, Side Wire	Self-Grounding, Side Wire	Self-Grounding, Side Wire	Self-Grounding, Side Wire	Self-Grounding, Side Wire
Rating	15A 120-277V AC	15A 120-277V AC	15A 120-277V AC	15A 120-277V AC	15A 120V (switch) 15A 125V (recept.) NEMA 5-15R	15A 120V 15A 125V NEMA 5-15R
Almond	RCD111AL	RCD101AL	RCD103AL	RCD108ALTR	RCD108AL	
Black	RCD111BK	RCD101BK	RCD103BK	RCD108BKTR	RCD108BK	
Gray	—	RCD101GY	RCD103GY	RCD108GYTR	RCD108GY	
Ivory	RCD111I	RCD101I	RCD103I	RCD108I	RCD108I	
Light Almond	RCD111LA	RCD101LA	RCD103LA	RCD108LATR	RCD108LA	
White	RCD111W	RCD101W	RCD103W	RCD108WTR	RCD108W	



RCD101W

Description	Two (2) Three Way Switches	 * Three Way Switch, Tamper-Resistant*, 2 Pole, 3 Wire, Receptacle	Three Way Switch, 2 Pole, 3 Wire Receptacle	Single Pole Switch, Pilot Light, Clear Lens, Amber Neon Bulb	Three Way Switch, Pilot Light, Clear Lens, Amber Neon Bulb
	Termination	Self-Grounding, Side Wire	Self-Grounding, Side Wire	Self-Grounding, Side Wire	Self-Grounding, Side Wire
Rating	15A 120-277V AC	15A 120V (switch) 15A 125V (recept.) NEMA 5-15R	15A 120V (switch) 15A 125V (recept.) NEMA 5-15R	15A 120V	15A 120V
Almond	RCD303AL	RCD308ALTR	RCD308AL	RCD109AL	RCD309AL
Black	RCD303BK	RCD308BKTR	RCD308BK	—	—
Gray	RCD303GY	RCD308GYTR	RCD308GY	—	—
Ivory	RCD303I	RCD308ITR	RCD308I	RCD109I	RCD309I
Light Almond	RCD303LA	RCD308LATR	RCD308LA	RCD109LA	RCD309LA
White	RCD303W	RCD308WTR	RCD308W	RCD109W	RCD309W



RCD108W

Note: * See Section X, page X-10 for TR description.



RCD109W

Pilot Light Wiring Diagram

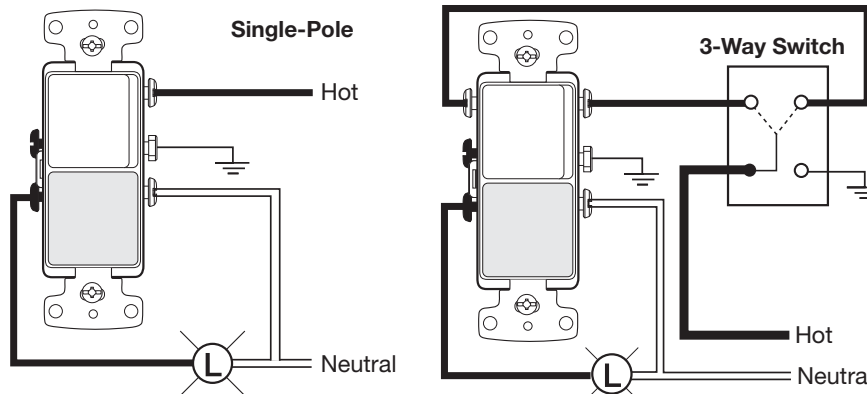



Decorator Duplex Receptacles, 2 Pole, 3 Wire

	*	*		
Description	Weather and Tamper-Resistant*	Tamper-Resistant*	Standard	Standard
Termination	Self-Grounding, Push and Side Wire	Self-Grounding, Push and Side Wire	Self-Grounding, Push and Side Wire	Push and Side Wire
Rating	15A 125V NEMA 5-15R	15A 125V NEMA 5-15R	15A 125V NEMA 5-15R	15A 125V NEMA 5-15R
Almond	RRD15SALWRTR	RRD15SALTR	RRD15SAL	RRD15AL
Black	RRD15SBKWRTR	RRD15SBKTR	RRD15SBK	RRD15BK
Brown	RRD15SWRTR	RRD15STR	RRD15S	RRD15
Gray	RRD15SGYWRTR	RRD15SGYTR	RRD15SGY	RRD15GY
Ivory	RRD15SIWRTR	RRD15SITR	RRD15SI	RRD15I
Light Almond	RRD15SLAWRTR	RRD15SLATR	RRD15SLA	RRD15LA
White	RRD15SWWRTR	RRD15SWTR	RRD15SW	RRD15W



	*		*	
Description	Tamper-Resistant*	Standard	Tamper-Resistant*, Without Ears**	Standard, Without Ears**
Termination	Self-Grounding, Eight Push Wire Holes Only #14 AWG	Self-Grounding, Eight Push Wire Holes Only #14 AWG	Self-Grounding, Push and Side Wire	Self-Grounding, Push and Side Wire
Rating	15A 125V NEMA 5-15R	15A 125V NEMA 5-15R	15A 125V NEMA 5-15R	15A 125V NEMA 5-15R
Almond	RRD15EALTR	RRD15EAL	RRD15KALTR	RRD15KAL
Black	RRD15EBKTR	RRD15EBK	RRD15KBKTR	RRD15KBK
Brown	RRD15ETR	RRD15E	RRD15KTR	RRD15K
Gray	RRD15EGYTR	RRD15EGY	RRD15KGYTR	RRD15KGY
Ivory	RRD15EITR	RRD15EI	RRD15KITR	RRD15KI
Light Almond	RRD15ELATR	RRD15ELA	RRD15KLATR	RRD15KLA
White	RRD15EWTR	RRD15EW	RRD15KWTR	RRD15KW



Note: * See Section X, page X-10 for WR and TR descriptions.
 ** 100 per case, bulk packed. Mounting screws inserted into strap.

Decorator Single Receptacles, 2 Pole, 3 Wire

	*		*	
Description	Tamper-Resistant*	Standard	Tamper-Resistant*	Standard
Termination	Self-Grounding, Side Wire	Self-Grounding, Side Wire	Self-Grounding, Side Wire	Self-Grounding, Side Wire
Rating	15A 125V NEMA 5-15R	15A 125V NEMA 5-15R	20A 125V NEMA 5-20R	20A 125V NEMA 5-20R
Almond	RRD151ALTR	RRD151AL	RRD201ALTR	RRD201AL
Black	RRD151BKTR	RRD151BK	RRD201BKTR	RRD201BK
Brown	RRD151TR	RRD151	RRD201TR	RRD201
Gray	RRD151GYTR	RRD151GY	RRD201GYTR	RRD201GY
Ivory	RRD151ITR	RRD151I	RRD201ITR	RRD201I
Light Almond	RRD151LATR	RRD151LA	RRD201LATR	RRD201LA
White	RRD151WTR	RRD151W	RRD201WTR	RRD201W



Description	Standard	Standard
Termination	Self-Grounding, Side Wire	Self-Grounding, Side Wire
Rating	15A 250V NEMA 6-15R	20A 250V NEMA 6-20R
Almond	RRD155AL	RRD205AL
Black	RRD155BK	RRD205BK
Brown	RRD155	RRD205
Gray	RRD155GY	RRD205GY
Ivory	RRD155I	RRD205I
Light Almond	RRD155LA	RRD205LA
White	RRD155W	RRD205W



Note: * See Section X, page X-10 for TR description.



tradeSELECT® Snap-On, Nylon and Metal Wallplates

Decorator Products

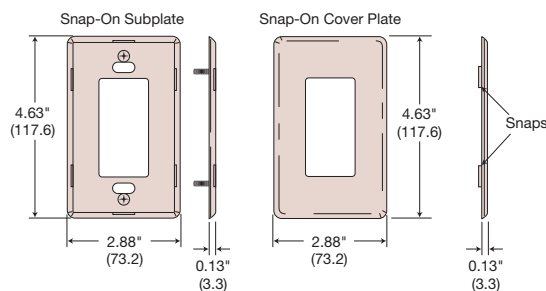

A subplate is fastened to the device, then a screwless snap-on cover plate is affixed. Four snaps securely hold the cover to the subplate.

Snap-On, Nylon, Two Piece Construction Wallplates

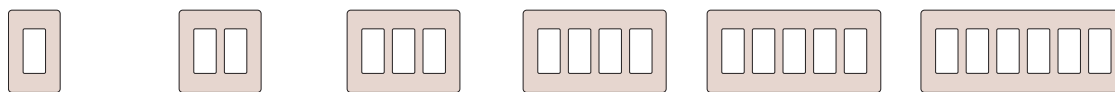

Color	1-Gang, 1-Decorator	2-Gang, 2-Decorator	3-Gang, 3-Decorator	4-Gang, 4-Decorator	5-Gang, 5-Decorator	6-Gang, 6-Decorator
Almond	RCW1AL	RCW2AL	RCW3AL	RCW4AL	RCW5AL	RCW6AL
Ivory	RCW1I	RCW2I	RCW3I	RCW4I	RCW5I	RCW6I
Light Almond	RCW1LA	RCW2LA	RCW3LA	RCW4LA	RCW5LA	RCW6LA
White	RCW1W	RCW2W	RCW3W	RCW4W	RCW5W	RCW6W

Decorator, Standard, Nylon Wallplates

Color	1-Gang, 1-Decorator	2-Gang, 2-Decorator	3-Gang, 3-Decorator	4-Gang, 4-Decorator	5-Gang, 5-Decorator	6-Gang, 6-Decorator
Almond	NP26AL	NP262AL	NP263AL	NP264AL	NP265AL	NP266AL
Black	NP26BK	NP262BK	NP263BK	NP264BK	NP265BK	NP266BK
Brown	NP26	NP262	NP263	NP264	NP265	NP266
Gray	NP26GY	NP262GY	NP263GY	NP264GY	NP265GY	NP266GY
Ivory	NP26I	NP262I	NP263I	NP264I	NP265I	NP266I
Light Almond	NP26LA	NP262LA	NP263LA	NP264LA	NP265LA	NP266LA
White	NP26W	NP262W	NP263W	NP264W	NP265W	NP266W

Decorator, Mid-Size, Nylon Wallplates

Color	1-Gang, 1-Decorator	2-Gang, 2-Decorator	3-Gang, 3-Decorator	4-Gang, 4-Decorator	5-Gang, 5-Decorator	6-Gang, 6-Decorator
Almond	NPJ26AL	NPJ262AL	NPJ263AL	NPJ264AL	—	—
Black	NPJ26BK	NPJ262BK	NPJ263BK	NPJ264BK	—	—
Brown	NPJ26	NPJ262	NPJ263	NPJ264	—	—
Gray	NPJ26GY	NPJ262GY	NPJ263GY	NPJ264GY	—	—
Ivory	NPJ26I	NPJ262I	NPJ263I	NPJ264I	—	—
Light Almond	NPJ26LA	NPJ262LA	NPJ263LA	NPJ264LA	—	—
White	NPJ26W	NPJ262W	NPJ263W	NPJ264W	—	—

Decorator, Mid-Size, Metal Wallplates

Material	1-Gang, 1-Decorator	2-Gang, 2-Decorator	3-Gang, 3-Decorator	4-Gang, 4-Decorator	5-Gang, 5-Decorator	6-Gang, 6-Decorator
Brass	SB26	SB262	—	—	—	—
Brass Plated	SBP26	SBP262	SBP263	—	—	—
Chrome	SCH26	SCH262	—	—	—	—
S/S 302/304	SS26	SS262	SS263	SS264	SS265	SS266
S/S 430	SS26L	SS262L	—	—	—	—

tradeSELECT® Combination Wallplates

Decorator Products



Combination, Nylon, Standard Wallplates

Color	2-Gang, 1-Toggle 1-Decorator	2-Gang, 1-Duplex, 1-Decorator	2-Gang, 1-Blank Box Mount 1-Decorator	3-Gang, 2-Toggle 1-Decorator	3-Gang, 1-Toggle 2-Decorator	4-Gang, 3-Toggle 1-Decorator	4-Gang, 2-Toggle 2-Decorator
Almond	NP126AL	NP826AL	NP1326AL	NP226AL	NP1262AL	NP326AL	NP2262AL
Black	NP126BK	NP826BK	NP1326BK	NP226BK	NP1262BK	NP326BK	NP2262BK
Brown	NP126	NP826	NP1326	NP226	NP1262	NP326	NP2262
Gray	NP126GY	NP826GY	NP1326GY	NP226GY	NP1262GY	NP326GY	NP2262GY
Ivory	NP126I	NP826I	NP1326I	NP226I	NP1262I	NP326I	NP2262I
Light Almond	NP126LA	NP826LA	NP1326LA	NP226LA	NP1262LA	NP326LA	NP2262LA
White	NP126W	NP826W	NP1326W	NP226W	NP1262W	NP326W	NP2262W

Combination, Nylon, Mid-Size Wallplates

Color	2-Gang, 1-Toggle 1-Decorator	2-Gang, 1-Duplex, 1-Decorator	2-Gang, 1-Blank Box Mount 1-Decorator	3-Gang, 2-Toggle 1-Decorator	3-Gang, 1-Toggle 2-Decorator	4-Gang, 3-Toggle 1-Decorator	4-Gang, 2-Toggle 2-Decorator
Almond	NPJ126AL	NPJ826AL	NPJ1326AL	NPJ226AL	—	—	—
Black	NPJ126BK	NPJ826BK	—	NPJ226BK	—	—	—
Brown	NPJ126	NPJ826	NPJ1326	NPJ226	—	—	—
Gray	NPJ126GY	NPJ826GY	—	NPJ226GY	—	—	—
Ivory	NPJ126I	NPJ826I	NPJ1326I	NPJ226I	—	—	—
Light Almond	NPJ126LA	NPJ826LA	NPJ1326LA	NPJ226LA	—	—	—
White	NPJ126W	NPJ826W	NPJ1326W	NPJ226W	—	—	—

Combination, Standard, Metal Wallplates

Material	2-Gang, 1-Toggle 1-Decorator	2-Gang, 1-Duplex, 1-Decorator	2-Gang, 1-Blank Strap Mount 1-Decorator	3-Gang, 2-Toggle 1-Decorator	3-Gang, 1-Toggle 2-Decorator	4-Gang, 3-Toggle 1-Decorator	4-Gang, 2-Toggle 2-Decorator
Brass	SB126	SB826	—	—	—	—	—
Brass Plated	SBP126	—	—	—	—	—	—
Chrome	—	—	—	—	—	—	—
SS 302/304	SS126	SS826	SS1426	SS226	—	SS326	—
SS 430	SS126L	—	—	—	—	—	—

Product Dimensions

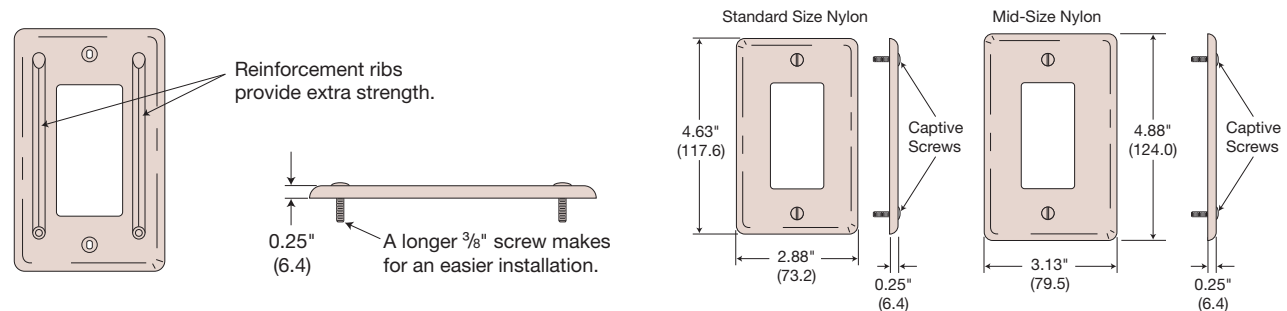

tradeSELECT® Decorator Frames

Decorator Products



Features

Decorator frames provide a stylized look for that finishing touch. This allows all devices to match. Multimedia jacks insert into frame for custom configuration.

- Elongated strap for better wall box mounting
- High impact-resistant thermoplastic frame
- UL Listed 1863 - Communication Circuit Accessory and CSA Certified

Customize the jack selections and look



+



=



Decorator Frames



Color	1-Gang, 2-Port	1-Gang, 3-Port	1-Gang, 4-Port	1-Gang, 6-Port	1-Gang, Adapter .406" (10.30) Dia. Hole*	1-Gang, Adapter Blank**
Almond	NS612AL	NS613AL	NS614AL	NS616AL	NS621AL	NS620AL
Black	NS612BK	NS613BK	NS614BK	NS616BK	—	—
Gray	NS612GY	NS613GY	NS614GY	NS616GY	—	—
Ivory	NS612I	NS613I	NS614I	NS616I	NS621I	NS620I
Light Almond	NS612LA	NS613LA	NS614LA	NS616LA	NS621LA	NS620LA
White	NS612W	NS613W	NS614W	NS616W	NS621W	NS620W

Note: * For use with rotary dimmers or to pull through AV or telephone cable.

** To fill an extra decorator opening or to create customized openings.

tradeSELECT® Modular Snap Fit Jacks

Decorator Products



Features

netSELECT® Voice/Data Jacks and AV Connectors allow custom creation of multimedia outlets and workstations while maintaining a decorative look.

- Quick and secure snap-in design
- Use with multimedia plates and decorator frames (see pages V-8 and V-39)
- UL Listed and CSA Certified, or cULus Listed 1863 - Communication Circuit Accessory

Molded-In Voice/Low-Speed Data

Description	Modular Snap Fit Cat. 6 Jack	Modular Snap Fit Cat. 5e Jack	Modular Snap Fit USOC Jack
Color			
Almond	NSJ6AL	NSJ5EAL	NSJUAL
Black	NSJ6BK	NSJ5EBK	NSJUBK
Blue	NSJ6B	NSJ5EB	NSJUB
Gray	NSJ6GY	NSJ5EGY	NSJUGY
Green	NSJ6GN	NSJ5EGN	NSJUGN
Ivory	NSJ6I	NSJ5EI	NSJUI
Light Almond	NSJ6LA	NSJ5ELA	NSJULA
Orange	NSJ6OR	NSJ5EOR	NSJUOR
Red	NSJ6R	NSJ5ER	NSJUR
White	NSJ6W	NSJ5EW	NSJUW
Yellow	NSJ6Y	NSJ5EY	NSJUY

Audio/Video Connectors - Standard Bulkhead

Description	Gold F-Type Coupler Bulkhead, Female to Female	Nickel F-Type Coupler Bulkhead, Female to Female	RCA Gold Pass Through, Female to Female, Red Interior	RCA Gold Pass Through, Female to Female, White Interior	RCA Gold Pass Through, Female to Female, Yellow Interior	RCA Gold Pass Through, Female to Female, Blue Interior	RCA Gold Pass Through, Female to Female, Green Interior
Color							
Almond	SFFGAL	NSF70AL	SFRCRFFAL	SFRCWFFAL	SFRCYFFAL	SFRCBFFAL	SFRCGNFFAL
Black	SFFGBK	NSF70BK	SFRCRFFBK	SFRCWFFBK	SFRCYFFBK	SFRCBFFBK	SFRCGNFFBK
Gray	SFFGGY	NSF70GY	SFRCRFFGY	SFRCWFFGY	SFRCYFFGY	SFRCBFFGY	SFRCGNFFGY
Ivory	SFFGEI	NSF70I	SFRCRFFEI	SFRCWFFEI	SFRCYFFEI	SFRCBFFEI	SFRCGNFFEI
Light Almond	SFFGLA	NSF70LA	SFRCRFFLA	SFRCWFFLA	SFRCYFFLA	SFRCBFFLA	SFRCGNFFLA
White	SFFGW	NSF70W	SFRCRFFW	SFRCWFFW	SFRCYFFW	SFRCBFFW	SFRCGNFFW

Audio/Video Connectors - Recessed

Description	Gold F-Type Coupler Bulkhead, Female to Female	RCA Gold Pass Through, Female to Female, Red Interior	RCA Gold Pass Through, Female to Female, White Interior	RCA Gold Pass Through, Female to Female, Yellow Interior	RCA Gold Pass Through, Female to Female, Blue Interior	RCA Gold Pass Through, Female to Female, Green Interior	Blank Insert
Color							
Almond	SFGRFAL	SFRCRRAL	SFRCWRAL	SFRCYRAL	SFRCBRAL	SFRCGNRAL	SFSBAL10*
Black	SFGRFBK	SFRCRRBK	SFRCWRBK	SFRCYRBK	SFRCBRBK	SFRCGNRBK	SFSBBK10*
Gray	SFGRFGY	SFRCRRGY	SFRCWRGY	SFRCYRGY	SFRCBRGY	SFRCGNRGY	SFSBGY10*
Ivory	SFGRFEI	SFRCRREI	SFRCWREI	SFRCYREI	SFRCBREI	SFRCGNREI	SFSBEI10*
Light Almond	SFGRFLA	SFRCRRLA	SFRCWRLA	SFRCYRLA	SFRCBRLA	SFRCGNRLA	SFSBLA10*
White	SFGRFW	SFRCRRW	SFRCWRW	SFRCYRW	SFRCBRW	SFRCGNRW	SFSBW10*

Note: * Sold in a package of 10. Order 1 to receive a bag of 10 blanks.

tradeSELECT® Molded-In Voice/Data/Video



Decorator Products

Features

Designed to complement decorator styling, these jacks offer voice and Cat. 5e devices to fit within a decorator wallplate.

- High impact-resistant thermoplastic frame
- Meets FCC part 68
- UL Listed 1863 - Communication Circuit Accessory and CSA Certified

Molded-In Voice/Low-Speed Data

Description	Decorator Frame, One RJ11 Jack, 6-Position, 4-Conductor	Decorator Frame, One RJ11 Jack, 6-Position, 6-Conductor	Decorator Frame, Duplex RJ11 Jacks, 6-Position, 6-Conductor	Decorator Frame, One Cat. 5e 110 Punch-Down, One RJ11 Jack, 6-Position, 4-Conductor
Termination	Screw Terminations	Screw Terminations	Screw Terminations	Screw Terminations



Color

Almond	NS770AL	NS771AL	NS772AL	NS784AL
Black	NS770BK	—	—	NS784BK
Brown	NS770	NS771	—	NS784
Gray	NS770GY	—	—	NS784GY
Ivory	NS770I	NS771I	NS772I	NS784I
Light Almond	NS770LA	NS771LA	NS772LA	NS784LA
White	NS770W	NS771W	NS772W	NS784W

Features

Coaxial video and combination jacks complement multimedia needs in a 1-gang decorator opening.

- High impact-resistant thermoplastic frame
- Jacks meet FCC part 68
- UL Listed 1863 - Communication Circuit Accessory and CSA Certified

Molded-In Voice/Low-Speed Data

Description	Decorator Frame, Single F-Type Coupler Bulkhead, Female to Female	Decorator Frame, Duplex F-Type Coupler Bulkhead, Female to Female	Decorator Frame, One RJ11 Jack, 6-Position, 4-Conductor, One F-Type Coupler Bulkhead, Female to Female	Decorator Frame, One Cat. 5e 110 Punch-Down, One F-Type Coupler Bulkhead, Female to Female
Termination	Screw Terminations	Screw Terminations	Screw Terminations	Screw Terminations



Color

Almond	NS780AL	NS782AL	NS783AL	NS785AL
Black	—	—	—	NS785BK
Brown	—	—	—	NS785
Gray	—	—	—	NS785GY
Ivory	NS780I	NS782I	NS783I	NS785I
Light Almond	NS780LA	NS782LA	NS783LA	NS785LA
White	NS780W	NS782W	NS783W	NS785W

tradeSELECT®
Toggle Switches and Combination Switches/Devices



Features

Standard toggle switches provide the basic on/off control for home lighting and appliances.

- Tough thermoplastic with ultrasonically welded cover and base

- Elongated strap for easier wall box mounting
- Hi-visibility yellow base for easy installation
- Operating temperature: -20°C to 60°C
- UL Listed E3896, CSA Certified

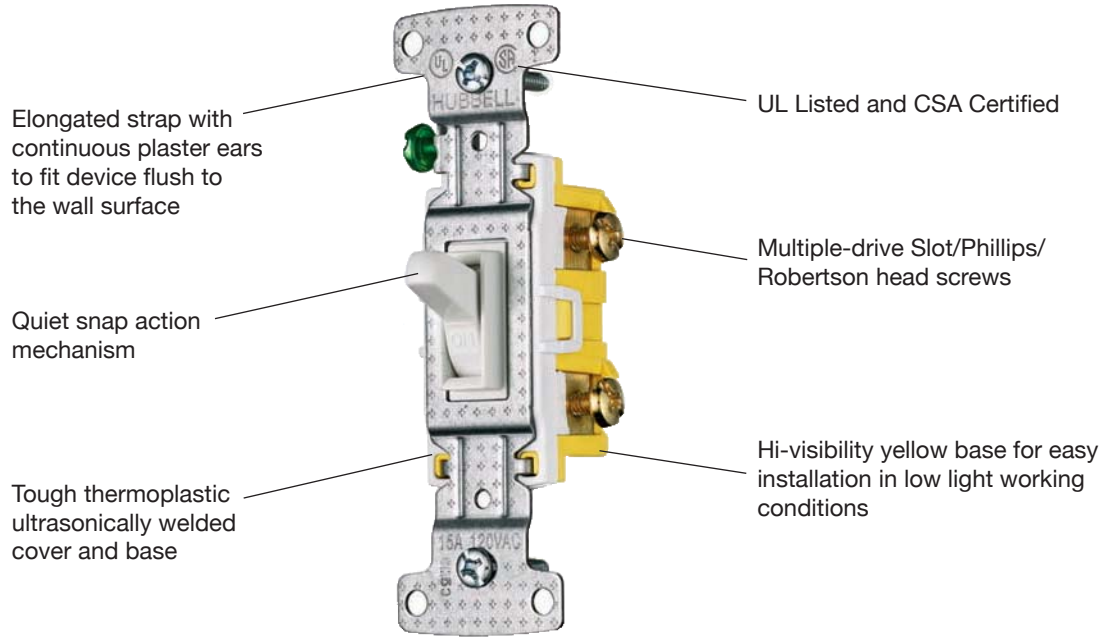

Features

Mini-toggles provide for multiple switches in a compact single gang. Maximize control while maintaining function and appearance.

- Low profile, less than 1 inch

- Self-grounding feature is standard
- Smooth toggle action
- Operating temperature: -20°C to 60°C
- UL Listed, CSA Certified

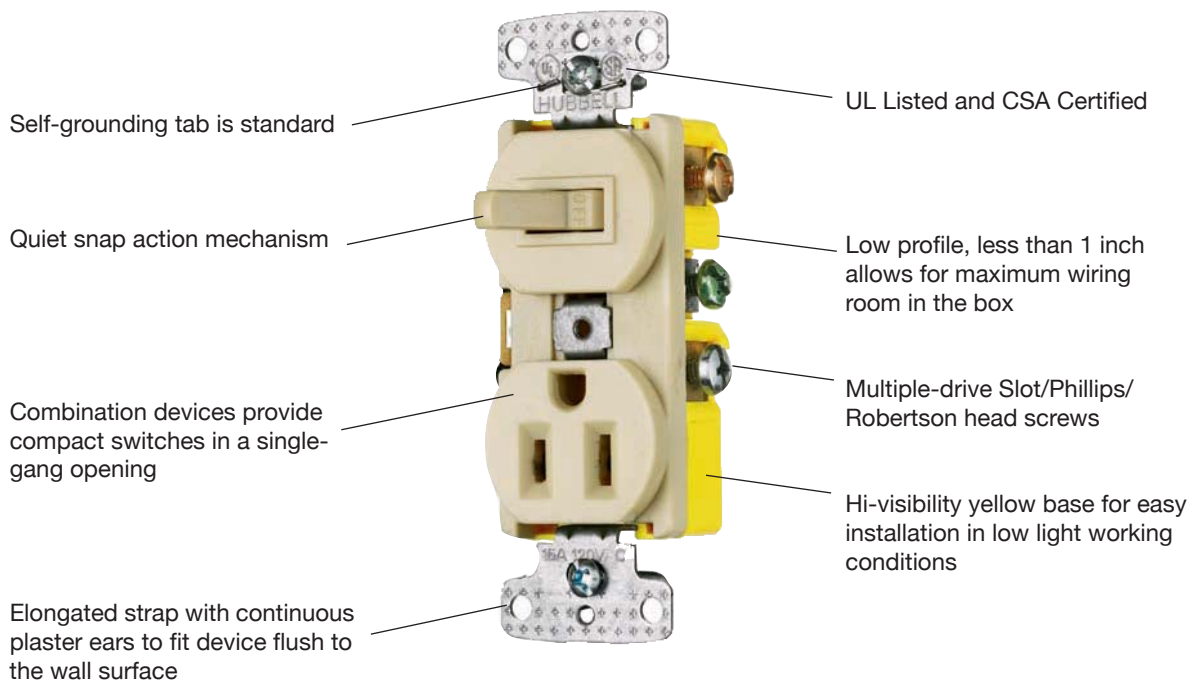

tradeSELECT® Three and Four Way Toggle Switches



Single Pole Toggle Switches

Description	Single Pole	Single Pole, Without Ears*	Single Pole	Single Pole, Illuminated**
Termination	Grounding, Push and Side Wire	Grounding, Push and Side Wire	Self-Grounding, Push and Side Wire	Self-Grounding, Push and Side Wire
Rating	15A 120V AC	15A 120V AC	15A 120V AC	15A 120V AC



Color

Clear	—	—	—	RS115ILC
Almond	RS115AL	RS115KAL	RS115SAL	RS115ILAL
Black	RS115BK	—	—	—
Brown	RS115	—	RS115S	—
Ivory	RS115I	RS115KI	RS115SI	RS115ILI
Light Almond	RS115LA	RS115KLA	RS115SLA	RS115ILLA
White	RS115W	RS115KW	RS115SW	RS115ILW

Note: * 100 per case, bulk packed. Mounting screws inserted into strap.

** Frame is clear and illuminates, toggle is colored. Does not require a neutral wire.

Three and Four Way Toggle Switches

Description	Three Way	Three Way, Without Ears*	Three Way	Three Way, Illuminated**	Four Way
Termination	Grounding, Push and Side Wire	Self-Grounding, Push and Side Wire	Self-Grounding, Push and Side Wire	Self-Grounding, Push and Side Wire	Self-Grounding, Side Wire
Rating	15A 120V AC	15A 120V AC	15A 120V AC	15A 120V AC	15A 120V AC







Color

Clear	—	—	—	RS315ILC	—
Almond	RS315AL	RS315KAL	RS315SAL	RS315ILAL	RS415AL
Black	RS315BK	—	—	—	RS415BK
Brown	RS315	—	RS315S	—	RS415
Ivory	RS315I	RS315KI	RS315SI	RS315ILI	RS415I
Light Almond	RS315LA	RS315KLA	RS315SLA	RS315ILLA	RS415LA
White	RS315W	RS315KW	RS315SW	RS315ILW	RS415W

Note: * 100 per case, bulk packed. Mounting screws inserted into strap.







** Frame is clear and illuminates, toggle is colored. Does not require a neutral wire.

Combination Toggle Switches/Devices

		 *		
Description	Two (2) Single Pole Switches	Single Pole Switch, Tamper-Resistant*, 2 Pole, 3 Wire, Receptacle	Single Pole Switch, 2 Pole, 3 Wire, Receptacle	Single Pole Switch, Pilot Light, Clear Lens, Amber Neon Bulb**
Termination	Self-Grounding, Side Wire	Self-Grounding, Side Wire	Self-Grounding, Side Wire	Self-Grounding, Side Wire
Rating	15A 120V AC	15A 120V (switch) 15A 125V (recept.) NEMA 5-15R	15A 120V (switch) 15A 125V (recept.) NEMA 5-15R	15A 120V AC
				
Color				
Almond	RC101AL	RC108ALTR	RC108AL	RC109AL
Brown	RC101	RC108TR	RC108	RC109
Ivory	RC101I	RC108ITR	RC108I	RC109I
Light Almond	RC101LA	RC108LATR	RC108LA	RC109LA
White	RC101W	RC108WTR	RC108W	RC109W

Note: * See Section X, page X-10 for TR description.
 ** Neutral required for pilot light, see page V-4 for wiring diagram.

Combination Toggle Switches/Devices

		 *			
Description	Single Pole and Three Way Switch	Two (2) Three Way Switches	Three Way Switch, Tamper-Resistant*, 2 Pole, 3 Wire, Receptacle	Three Way Switch, 2 Pole, 3 Wire, Receptacle	Three Way Switch, Pilot Light, Clear Lens, Amber Neon Bulb**
Termination	Self-Grounding, Side Wire	Self-Grounding, Side Wire	Self-Grounding, Side Wire	Self-Grounding, Side Wire	Self-Grounding, Side Wire
Rating	15A 120V AC	15A 120V AC	15A 120V (switch) 15A 125V (recept.) NEMA 5-15R	15A 120V (switch) 15A 125V (recept.) NEMA 5-15R	15A 120V AC
					
Color					
Almond	RC103AL	RC303AL	RC308ALTR	RC308AL	RC309AL
Brown	RC103	RC303	RC308TR	RC308	RC309
Ivory	RC103I	RC303I	RC308ITR	RC308I	RC309I
Light Almond	RC103LA	RC303LA	—	—	—
White	RC103W	RC303W	RC308WTR	RC308W	RC309W

Note: * See Section X, page X-10 for TR description.
 ** Neutral required for pilot light, see page V-4 for wiring diagram.

tradeSELECT® Duplex Quick Thread Receptacles



Quick And Easy Does It.

Residential exclusive “Quick Thread” makes installation of wallplates and receptacles quicker and easier.

Provides branch circuit convenience power in duplex and single configurations.

- Smooth indented face appearance
- Terminal screws accepts up to #12 AWG

- Duplex ultrasonically welded
- Push wire designed for #14 AWG solid copper wire only
- Operating temperature: -20°C to 60°C
- UL Listed E2186, CSA Certified

ONE PUSH FOR A SNUG FIT

Just push in the screw and turn.

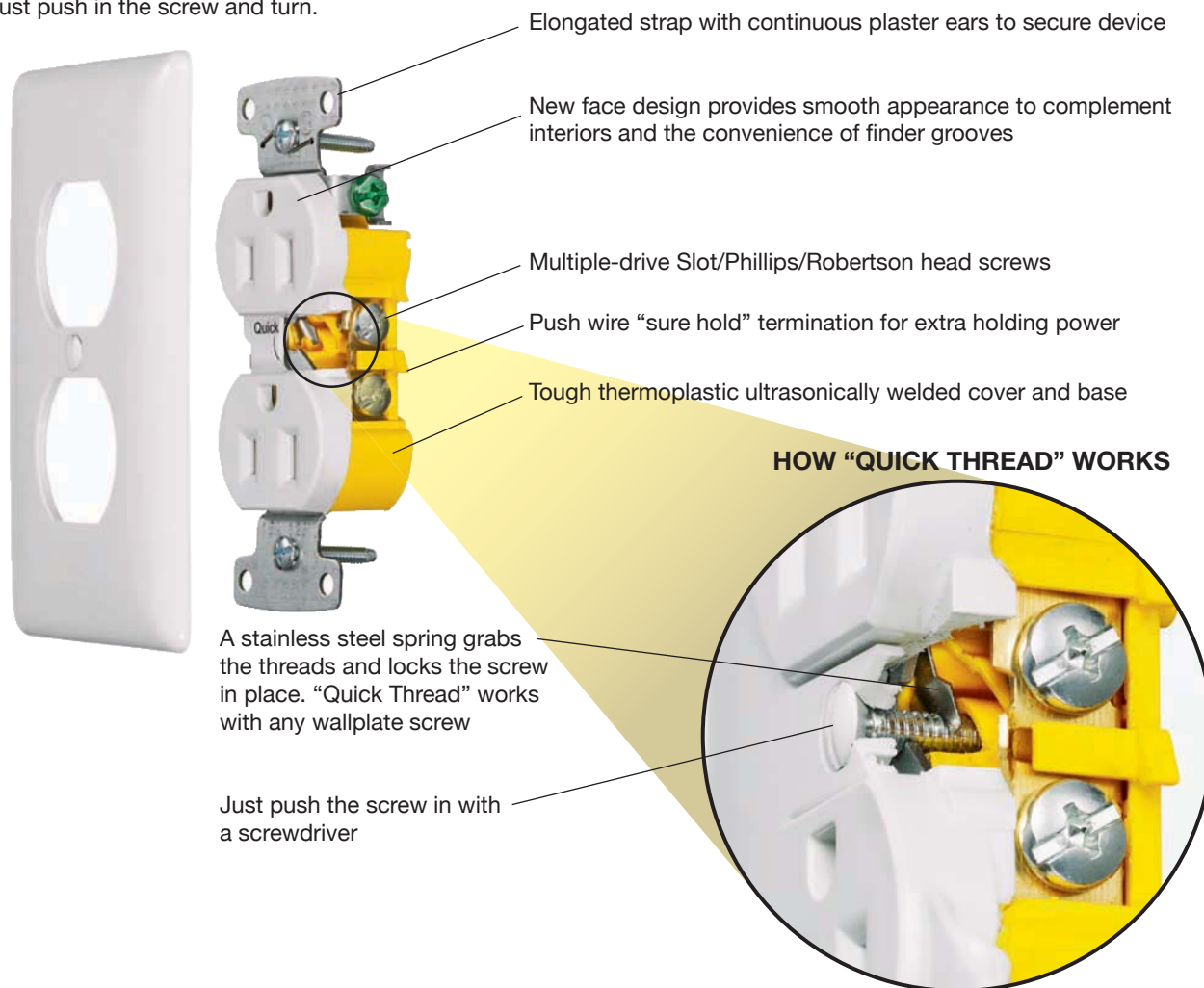

Duplex Quick Thread Receptacles, 2 Pole, 3 Wire



RR15QW

Description	Tamper-Resistant*, Quick Thread	Standard, Quick Thread	Tamper-Resistant*, Quick Thread	Standard, Quick Thread
	Termination	Self-Grounding, Push and Side Wire	Self-Grounding, Push and Side Wire	Eight Push Wire Holes Only #14 AWG
Rating	15A 125V NEMA 5-15R	15A 125V NEMA 5-15R	15A 125V NEMA 5-15R	15A 125V NEMA 5-15R
Almond	RR15QALTR	RR15QAL	RR15EQALTR	RR15EQAL
Black	RR15QBKTR	RR15QBK	RR15EQBKTR	RR15EQBK
Brown	RR15QTR	RR15Q	RR15EQTR	RR15EQ
Ivory	RR15QITR	RR15QI	RR15EQITR	RR15EQI
Light Almond	RR15QLATR	RR15QLA	RR15EQLATR	RR15EQLA
White	RR15QWTR	RR15QW	RR15EQWTR	RR15EQW

Note: * See Section X, page X-10 for TR description.

tradeSELECT® Duplex and Single Receptacles



Duplex Receptacles, 2 Pole, 3 Wire

Description	Standard	Weather and Tamper-Resistant*	Tamper-Resistant*	Standard
		Termination	Termination	
Termination	Grounding, Push and Side Wire	Self-Grounding, Push and Side Wire	Self-Grounding, Push and Side Wire	Self-Grounding, Push and Side Wire
Rating	15A 125V NEMA 5-15R	15A 125V NEMA 5-15R	15A 125V NEMA 5-15R	15A 125V NEMA 5-15R
Almond	RR15AL	RR15SALWRTR	RR15SALTR	RR15SAL
Black	RR15BK	RR15SBKWRTR	RR15SBKTR	RR15SBK
Brown	RR15	RR15SWRTR	RR15STR	RR15S
Ivory	RR15I	RR15SIWRTR	RR15SITR	RR15SI
Light Almond	RR15LA	RR15SLAWRTR	RR15SLATR	RR15SLA
White	RR15W	RR15SWWRTR	RR15SWTR	RR15SW
Description	Tamper-Resistant*, Without Ears	Standard, Without Ears	Tamper-Resistant*, Without Ears**	Standard, Without Ears**
	Termination	Termination	Termination	Termination
Termination	Eight Push Wire Holes Only #14 AWG	Eight Push Wire Holes Only #14 AWG	Eight Push Wire Holes Only #14 AWG	Eight Push Wire Holes Only #14 AWG
Rating	15A 125V NEMA 5-15R	15A 125V NEMA 5-15R	15A 125V NEMA 5-15R	15A 125V NEMA 5-15R
Almond	RR15EALTR	RR15EAL	RR15KALTR	RR15KAL
Black	RR15EBKTR	RR15EBK	—	—
Brown	RR15ETR	RR15E	RR15KTR	RR15K
Gray	RR15EGYTR	RR15EGY	—	—
Ivory	RR15EITR	RR15EI	RR15KITR	RR15KI
Light Almond	RR15ELATR	RR15ELA	RR15KLATR	RR15KLA
White	RR15EWTR	RR15EW	RR15KWTR	RR15KW



Single Receptacles, 2 Pole, 3 Wire

Description	Weather and Tamper-Resistant*	Tamper-Resistant*	Standard	Weather Resistant*	Standard
	Termination	Termination	Termination	Termination	Termination
Termination	Self-Grounding, Side Wire	Self-Grounding, Side Wire	Self-Grounding, Side Wire	Self-Grounding, Side Wire	Self-Grounding, Side Wire
Rating	15A 125V NEMA 5-15R	15A 125V NEMA 5-15R	15A 125V NEMA 5-15R	15A 250V NEMA 6-15R	15A 250V NEMA 6-15R
Almond	RR151ALWRTR	RR151ALTR	RR151AL	RR155ALWR	RR155AL
Black	RR151BKWRTR	RR151BKTR	RR151BK	RR155BKWR	RR155BK
Brown	RR151WRTR	RR151TR	RR151	RR155WR	RR155
Gray	RR151GYWRTR	RR151GYTR	RR151GY	RR155GYWR	RR155GY
Ivory	RR151IWRTR	RR151ITR	RR151I	RR155IWR	RR155I
Light Almond	RR151LAWRTR	RR151LATR	RR151LA	RR155LAWR	RR155LA
White	RR151WWRTR	RR151WTR	RR151W	RR155WWR	RR155W
Description	Weather and Tamper-Resistant*	Tamper-Resistant*	Standard	Weather Resistant*	Standard
	Termination	Termination	Termination	Termination	Termination
Termination	Self-Grounding, Side Wire	Self-Grounding, Side Wire	Self-Grounding, Side Wire	Self-Grounding, Side Wire	Self-Grounding, Side Wire
Rating	20A 125V NEMA 5-20R	20A 125V NEMA 5-20R	20A 125V NEMA 5-20R	20A 250V NEMA 6-20R	20A 250V NEMA 6-20R
Almond	RR201ALWRTR	RR201ALTR	RR201AL	RR205ALWR	RR205AL
Black	RR201BKWRTR	RR201BKTR	RR201BK	RR205BKWR	RR205BK
Brown	RR201WRTR	RR201TR	RR201	RR205WR	RR205
Gray	RR201GYWRTR	RR201GYTR	RR201GY	RR205GYWR	RR205GY
Ivory	RR201IWRTR	RR201ITR	RR201I	RR205IWR	RR205I
Light Almond	RR201LAWRTR	RR201LATR	RR201LA	RR205LAWR	RR205LA
White	RR201WWRTR	RR201WTR	RR201W	RR205WWR	RR205W



Note: * See Section X, page X-10 for WR and TR descriptions.
** 100 per case, bulk packed. Mounting screws inserted into strap.



tradeSELECT®

GFCI Receptacles with Auto Grounding

15 and 20 Ampere, 125 Volts AC

2 Pole, 3 Wire Grounding

Safety And Economy.

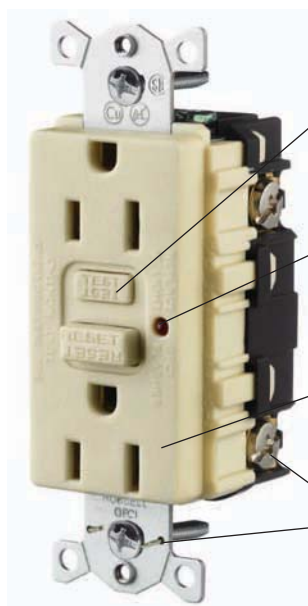
Meets UL Standard 943
Class A GFCI**GF15ILA****10kA Short Circuit Current Rating****Comprehensive diagnostics**

- When test button is actuated, both the electronic components and mechanical trip mechanism are functionally tested

Ground fault indicator

- Flashing **RED** indicates device has lost capability to provide protection

No power at face if reverse wired

- Open circuit condition eliminates false assumption of protection at face

Installation ease

- Internal back wiring
- Automatic grounding feature
- Captive mounting screws

**GF15ILA****GFTR20I****GFBF20ILA****GFCI Duplex Receptacles, Flush Nylon Face, Matching Nylon Wallplate Included**

Description	Weather and Tamper-Resistant	Standard	Weather and Tamper-Resistant	Standard
	Termination	Self-Grounding, Back and Side Wire	Self-Grounding, Back and Side Wire	Self-Grounding, Back and Side Wire
Rating	15A 125V AC NEMA 5-15R	15A 125V AC NEMA 5-15R	20A 125V AC NEMA 5-20R	20A 125V AC NEMA 5-20R
Almond	GFTR15AL	GF15ALLA	GFTR20AL	GF20ALLA
Black	GFTR15BK	GF15BKLA	GFTR20BK	GF20BKLA
Brown	GFTR15	GF15LA	GFTR20	GF20LA
Gray	GFTR15GY	GF15GYLA	GFTR20GY	GF20GYLA
Ivory	GFTR15I	GF15ILA	GFTR20I	GF20ILA
Light Almond	GFTR15LA	GF15LALA	GFTR20LA	GF20LALA
Red	GFTR15R	GF15RLA	GFTR20R	GF20RLA
White	GFTR15W	GF15WLA	GFTR20W	GF20WLA

Note: * See Section X, page X-10 for WR and TR descriptions.

GFCI Duplex Receptacles, Flush Nylon Face, Matching Nylon Wallplate Included

Description	Circuit Guard® Faceless
Termination	Self-Grounding, Back and Side Wire
Rating	20A 125V NEMA 5-20R
Almond	GFBF20ALLA
Black	GFBF20BKLA
Brown	GFBF20LA
Gray	GFBF20GYLA
Ivory	GFBF20ILA
Light Almond	GFBF20LALA
Red	GFBF20RLA
White	GFBF20WLA





Range and Dryer Power Receptacles and Plugs

30 and 50 Ampere, 125/250 Volts AC

3 Pole, 3 Wire and 3 Pole, 4 Wire



Range and Dryer Power Receptacles

	 30A 125/250V NEMA 14-30R UL/CSA	 50A 125/250V NEMA 14-50R UL/CSA	 30A 125/250V NEMA 10-30R UL/CSA	 50A 125/250V NEMA 10-50R UL/CSA
Description	Flush Mount for 1- or 2-Gang Box	Flush Mount for 1- or 2-Gang Box	Flush Mount for 1- or 2-Gang Box	Flush Mount for 1- or 2-Gang Box
Rating	30A 125/250V 3 Pole, 4 Wire with Ground	50A 125/250V 3 Pole, 4 Wire with Ground	30A 125/250V 3 Pole, 3 Wire without Ground	50A 125/250V 3 Pole, 3 Wire without Ground
Black	RR430F	RR450F	RR330F*	RR350F*
White	RR430FW	RR450FW	—	—
Description	Surface Mount	Surface Mount	Surface Mount	Surface Mount
Rating	30A 125/250V 3 Pole, 4 Wire with Ground	50A 125/250V 3 Pole, 4 Wire with Ground	30A 125/250V 3 Pole, 3 Wire without Ground	50A 125/250V 3 Pole, 3 Wire without Ground
Black	RR430	RR450	RR330*	RR350*
Description	Panel Mount	Panel Mount		
Rating	30A 125/250V 3 Pole, 4 Wire with Ground	50A 125/250V 3 Pole, 4 Wire with Ground		
Black	RR430PM	RR450PM		
White	—	—		

Note: * For replacement use only.



RR430FW







RR450



RR430PM

Range and Dryer Power Angled Plugs

	 30A 125/250V NEMA 14-30R UL/CSA	 50A 125/250V NEMA 14-50R UL/CSA	 30A 125/250V NEMA 10-30R UL/CSA	 50A 125/250V NEMA 10-50R UL/CSA
Description	With Interchangeable Blades for 30 or 50 Amp		With Interchangeable Blades for 30 or 50 Amp	
Rating	30/50A 125/250V 3 Pole, 4 Wire with Ground		30/50A 125/250V 3 Pole, 4 Wire without Ground	
Black	RR435P		RR335P	



RR435P

Wallplates, Surface Mount, 2.15" Diameter Single Hole

	1-Gang Standard	1-Gang Mid size	2-Gang Standard	2-Gang Mid size
Ivory	NP724I	NPJ724I	NP703I	NPJ703I
White	NP724W	NPJ724W	NP703W	NPJ703W
Chrome	SCH723	—	—	—
Stainless Steel	SS723	—	SS703	—



NP724W



NP703W

tradeSELECT®
Special Use Products
Switches and Receptacles



Special Use Products



RR151CHW



RJ650BK



RJ600



RDS50



RS100W



RS101W

Description	Color				
		Tamper-Resistant	Standard	Tamper-Resistant	Standard
Clock Hanger/Recessed Receptacle, 2 Pole, 3 Wire, Grounding, Side Wire Terminations	Brass Stainless Steel Ivory (Nylon) White (Nylon)	RR151CHBSTR RR151CHSSTR RR151CHITR RR151CHWTR	RR151CHBS RR151CHSS RR151CHI RR151CHW	RR201CHBSTR RR201CHSSTR RR201CHITR RR201CHWTR	RR201CHBS RR201CHSS RR201CHI RR201CHW
JLOAD® Multimedia Outlet Provides power, Cat. 5e and coaxial in a single gang box. Requires RJ600 Box. Includes decorator frame, one Cat. 5e, one F-connector and one power receptacle 125V with voltage divider.	Almond Black Gray Ivory Light Almond White	RJ650ALTR RJ650BKTR RJ650GYTR RJ650ITR RJ650LATR RJ650WTR	RJ650AL RJ650BK RJ650GY RJ650I RJ650LA RJ650W	RJ620ALTR RJ620BKTR RJ620GYTR RJ620ITR RJ620LATR RJ620WTR	RJ620AL RJ620BK RJ620GY RJ620I RJ620LA RJ620W
JLOAD® Multimedia Outlet Includes decorator frame with two open ports for custom configuration and one power receptacle 125V with voltage divider.	Almond Black Gray Ivory Light Almond White	RJ65ALTR RJ65BKTR RJ65GYTR RJ65ITR RJ65LATR RJ65WTR	RJ65AL RJ65BK RJ65GY RJ65I RJ65LA RJ65W	RJ62ALTR RJ62BKTR RJ62GYTR RJ62ITR RJ62LATR RJ62WTR	RJ62AL RJ62BK RJ62GY RJ62I RJ62LA RJ62W
JLOAD® Multimedia Box 3 inches deep with seven ½-inch knockouts, non-metallic sheathed cable clamps on each side. Screw in mounting to stud.	Steel	RJ600	RJ600	RJ600	RJ600

Note: See pages V-22 to V-27 for floor and under cabinet box options.
* See Section X, page X-10 for TR description.

Door Switch with Cover Plate and Box

Description	"ON" when Door is Open	"OFF" when Door is Open
Rating	3A 125V AC	3A 125V AC
Zinc Plated Steel	RDS50**	RDS30**

Note: ** Not UL Listed.

Product Dimensions

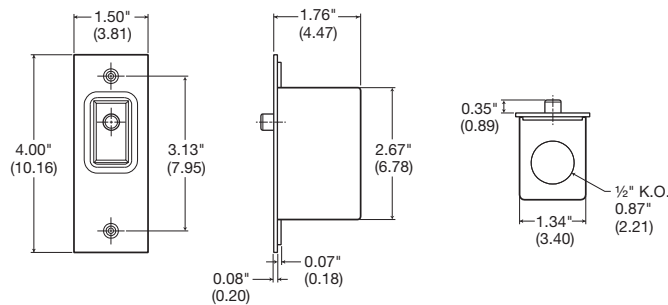

In-Line Cord Switches

Description	Mini For Use with Flat Lamp Cord	Heavy Duty
Rating	6A 125V AC	6A 125V AC 1/6 HP
Wire	#18 AWG SPT 1 and SPT 2	#18 to #16 AWG SPT 1 and SPT 2
Ivory White	RS100W	RS101I RS101W



tradeSELECT® Dimmers and Fan Speed Controls

Lighting Controls



Rocker Decorator Dimmers, Preset with Night Light

Description	Side Slide Adjustment, Incandescent	Side Slide Adjustment, Incandescent	Side Slide Adjustment, Incandescent	Side Slide Adjustment, Incandescent
Termination	Single Pole	Three Way	Single Pole	Three Way
Rating	1000W 120V AC	1000W 120V AC	600W 120V AC	600W 120V AC
Almond	RDV10PAL	RDV103PAL	RDV600PAL	RDV603PAL
Ivory	RDV10PI	RDV103PI	RDV600PI	RDV603PI
Light Almond	RDV10PLA	RDV103PLA	RDV600PLA	RDV603PLA
White	RDV10PW	RDV103PW	RDV600PW	RDV603PW



Description	Magnetic Low Voltage	Magnetic Low Voltage	Electronic Low Voltage	Electronic Low Voltage Requires Neutral
Termination	Single Pole	Three Way	Single Pole	Three Way
Rating	600VA (450W) 120V AC	600VA (450W) 120V AC	300W 120V AC	300W 120V AC
Almond	RDVLV600PAL	RDVLV603PAL	RDVELV300PAL	RDVELV303PAL
Ivory	RDVLV600PI	RDVLV603PI	RDVELV300PI	RDVELV303PI
Light Almond	RDVLV600PLA	RDVLV603PLA	RDVELV300PLA	RDVELV303PLA
White	RDVLV600PW	RDVLV603PW	RDVELV300PW	RDVELV303PW



Slide Dimmers, Preset with On/Off Switch

Description	Incandescent	Incandescent	Incandescent	Incandescent
Termination	Single Pole	Three Way	Single Pole	Three Way
Rating	1000W 120V AC	1000W 120V AC	600W 120V AC	600W 120V AC
Almond	RS10PAL	RS103PAL	RS600PAL	RS603PAL
Ivory	RS10PI	RS103PI	RS600PI	RS603PI
Light Almond	RS10PLA	RS103PLA	RS600PLA	RS603PLA
White	RS10PW	RS103PW	RS600PW	RS603PW



Description	Magnetic Low Voltage	Magnetic Low Voltage	Electronic Low Voltage	Electronic Low Voltage Requires Neutral
Termination	Single Pole	Three Way	Single Pole	Three Way
Rating	600VA (450W) 120V AC	600VA (450W) 120V AC	300W 120V AC	300W 120V AC
Almond	RSLV600PAL	RSLV603PAL	RSELV300PAL	RSELV303PAL
Ivory	RSLV600PI	RSLV603PI	RSELV300PI	RSELV303PI
Light Almond	RSLV600PLA	RSLV603PLA	RSELV300PLA	RSELV303PLA
White	RSLV600PW	RSLV603PW	RSELV300PW	RSELV303PW



Slide Dimmers, Specialty

Description	Incandescent Slide to Off	Incandescent Omni Slide Button
Termination	Single Pole	Single Pole/Three Way
Rating	600W 120V AC	600W 120V AC
Ivory	RS600I	RS613PI
Light Almond	RS600LA	RS613PLA
White	RS600W	RS613PW

Fan Speed Controls, 3 Speed and Replacement Knobs

Description	Rocker Slide Adjustment	Slide Control Slide to Off	Combination Slide Dimmer, Incandescent	Replacement Knob
Termination	Single Pole/Three Way	Single Pole	Single Pole	—
Rating	1.5A 120V AC	1.5A 120V AC	300W 1.5A 120V AC	—
Almond	RDVFSQFAL	RSFSQFAL	RS2LFSQAL	RSKAL
Ivory	RDVFSQFI	RSFSQFI	RS2LFSQI	RSKI
Light Almond	RDVFSQFLA	RSFSQFLA	RS2LFSQLA	RSKLA
White	RDVFSQFW	RSFSQFW	RS2LFSQW	RSKW

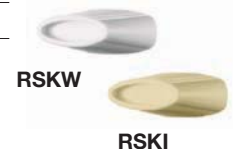



RAY600PW

Toggle Incandescent Preset Dimmers

Description	Side Slide Adjustment with Wire Leads	Side Slide Adjustment with Wire Leads	Side Slide Adjustment with Terminal Screws	Side Slide Adjustment with Terminal Screws
Termination	Single Pole	Three Way	Single Pole	Three Way
Rating	1000W 120V AC	1000W 120V AC	600W 120V AC	600W 120V AC
Almond	RAY10PAL	RAY103PAL	RAY600PAL	RAY603PAL
Ivory	RAY10PI	RAY103PI	RAY600PI	RAY603PI
Light Almond	RAY10PLA	RAY103PLA	RAY600PLA	RAY603PLA
White	RAY10PW	RAY103PW	RAY600PW	RAY603PW



RD600RW

Rotary Incandescent Dimmers and Replacement Knobs

Description	On/Off Dimmer	Push On/Off Dimmer Ivory and White Knobs Provided	Push On/Off Dimmer Ivory and White Knobs Provided	Replacement Knobs 2 Piece Kit
Termination	Single Pole	Single Pole	Three Way	—
Rating	600W 120V AC	600W 120V AC	600W 120V AC	—
Ivory	RD600RI	—	—	—
White	RD600RW	—	—	—
Ivory/White	—	RD600PDK	RD603PDK	RRKDK



RRKDK



RAY2LFSQW

Fan Speed Controls

Description	Toggle 3-Speed	Combination Toggle 3-Speed/Dimmer	Rotary On/Off 3-Speed includes Ivory and White knobs	Rotary Variable Speed	Rotary Fan Control Replacement Knobs
Termination	Single Pole or Three Way	Single Pole	Single Pole	Single Pole	—
Rating	1.5A 120V AC	300W 1.5A 120V AC	1.5A 120V AC	5A 120V AC	—
Almond	RAYFSQFAL	RAY2LFSQAL	—	—	—
Ivory	RAYFSQFI	RAY2LFSQI	—	RFS5I	R28032406
Light Almond	RAYFSQFLA	RAY2LFSQLA	—	RFS5LA	—
White	RAYFSQFW	RAY2LFSQW	—	—	R28032401
Ivory/White	—	—	RFSQ2FDK	RFS5W	—



RFSQ2FDK



R28032401

R28032406



Occupancy Sensors

Auto-on occupancy sensors turn on the load when motion is detected in an area. The device turns lights off when motion ceases and the time delay has expired.

Description	Occupancy Sensor Basic On/Off Control 150° View Standard	Occupancy Sensor Basic On/Off Control 150° View With Nightlight	Occupancy Sensor Dimming Control 150° View Standard	Occupancy Sensor Dimming Control 150° View With Nightlight
Termination	Single Pole Switch	Single Pole Switch	Single Pole Switch	Single Pole Switch
Rating	500W 120V AC Incandescent Only	500W 120V AC Incandescent Only	500W 120V AC Incandescent Only	500W 120V AC Incandescent Only
Almond	RMS101AL	RMS101ILAL	RMS121AL	RMS121ILAL
Ivory	RMS101I	RMS101ILI	RMS121I	RMS121ILI
Light Almond	RMS101LA	RMS101ILLA	RMS121LA	RMS121ILLA
White	RMS101W	RMS101ILW	RMS121W	RMS121ILW



RMS101W
RMS100W

Vacancy Sensors

Vacancy sensor switches are specifically designed for California Title 24 compliance. When a person enters an area, the manual switch must be pressed to turn on the light. The device turns lights off when motion ceases and the time delay has expired.

Description	Vacancy Sensor Basic On/Off Control 150° View Standard	Vacancy Sensor Basic On/Off Control 150° View With Nightlight	Vacancy Sensor Dimming Control 150° View Standard	Vacancy Sensor Dimming Control 150° View With Nightlight
Termination	Single Pole Switch	Single Pole Switch	Single Pole Switch	Single Pole Switch
Rating	500W 120V AC Incandescent Only	500W 120V AC Incandescent Only	500W 120V AC Incandescent Only	500W 120V AC Incandescent Only
Almond	RMS100AL	RMS100ILAL	RMS120AL	RMS120ILAL
Ivory	RMS100I	RMS100ILI	RMS120I	RMS120ILI
Light Almond	RMS100LA	RMS100ILLA	RMS120LA	RMS120ILLA
White	RMS100W	RMS100ILW	RMS120W	RMS120ILW



RMS121ILW
RMS120ILW

Heavy Duty Occupancy and Vacancy Sensors

Description	Occupancy Sensor 180° View	Vacancy Sensor 180° View
Termination	Single Pole	Single Pole
Rating	800W Inc., 1000W Fluor., 120V AC 1800W Fluor., 277V AC 1/8 HP 120V AC	800W Inc., 1000W Fluor., 120V AC 1800W Fluor., 277V AC 1/8 HP 120V AC
Almond	RMS141AL	RMS140AL
Ivory	RMS141I	RMS140I
White	RMS141W	RMS140W



RMS141W
RMS140W

Coverage for Occupancy and Vacancy Sensors

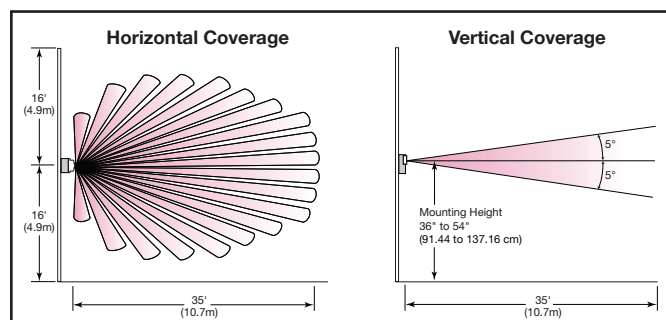

Coverage for Heavy Duty Occupancy and Vacancy Sensors

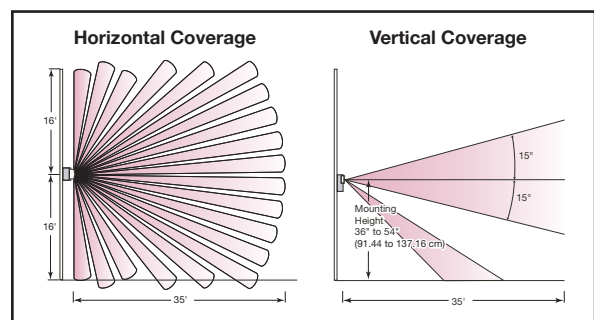

tradeSELECT® Floor Boxes For Wood Floors

Power Delivery



Hubbell Wood Floor Boxes allow for the placement of electrical power or a combination of power and voice/data devices. Boxes easily mount into the floor and are height adjustable (up to 3/4 inch) for optimal alignment and fit.

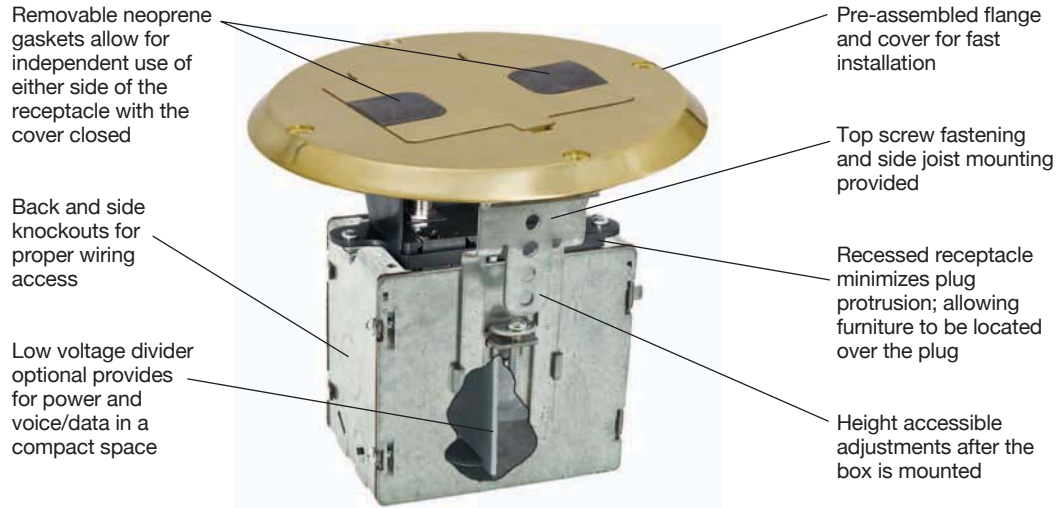

Note: Template cutout provided with instructions for proper installation.

The Right Choice For That Perfect Finishing Touch!

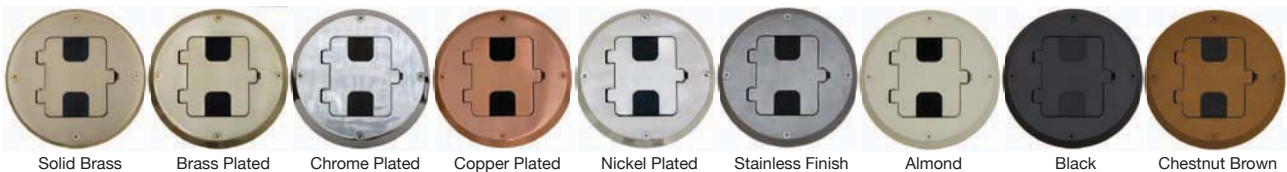

Note: Not all configurations are available in all colors. See below for details.

Floor Boxes For Structural Wood Floors



RF515BR

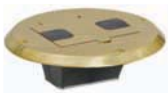

RF506BR



RF500



RF507BR

Description	Material	Finish	Cat. Number	Material	Finish	Cat. Number
Decorator duplex receptacle floor box kit; includes steel box, flange and hinged door cover assembly with 15A 125V tamper-resistant duplex receptacle; designed for installation in wood floors; mounts to sub-floor or joists.	Solid Brass	Clear Lacquer	RF515BR	Aluminum	Brass Plated	RF515BP
	Aluminum	Stainless Paint	RF515SS	Aluminum	Chrome Plated	RF515CH
	Aluminum	Almond Paint	RF515AL	Aluminum	Copper Plated	RF515CU
	Aluminum	Black Paint	RF515BK	Aluminum	Nickel Plated	RF515NI
	Aluminum	Chestnut Brown Paint	RF515BN			
Flush fit (same as above).	Solid Brass	Clear Lacquer	RF509BR			
Flange and hinged door cover assembly; includes tamper-resistant duplex receptacle; neoprene gaskets; for use with steel box RF500.	Solid Brass	Clear Lacquer	RF506BR	Aluminum	Brass Plated	RF506BP
	Aluminum	Stainless Paint	RF506SS	Aluminum	Chrome Plated	RF506CH
	Aluminum	Almond Paint	RF506AL	Aluminum	Copper Plated	RF506CU
	Aluminum	Black Paint	RF506BK	Aluminum	Nickel Plated	RF506NI
	Aluminum	Chestnut Brown Paint	RF506BN			
Adjustable floor box; 3 inch deep; three (3) 1/2 inch knockouts: one on bottom; one on each side; non-metallic sheathed cable clamps on each side.				Steel	—	RF500
Hinged Door Cover Only Replacement door for RF515, RF509 and RF506 series.	Solid Brass	Solid Brass	RF507BR	Aluminum	Brass Plated	RF507BP
	Aluminum	Stainless Finish	RF507SS	Aluminum	Chrome Plated	RF507CH
	Aluminum	Almond	RF507AL	Aluminum	Copper Plated	RF507CU
	Aluminum	Black	RF507BK	Aluminum	Nickel Plated	RF507NI
	Aluminum	Chestnut Brown Paint	RF507BN			



tradeSELECT® Floor Boxes For Wood Floors

Power Delivery



Duplex floor receptacles provide ample connections to service lighting, entertainment equipment and computers for family rooms and offices. Single receptacle configurations available for minimum requirements.

- Metal covers feature electrostatic powder coating that resists wear and provides a distinctive finish
- Recessed GFCI/Decorator opening
- Cut out template provided to assure proper sub-flooring preparation

Drop-in Floor Box

Drop-In Floor Boxes are perfect for quick and easy installation of power or low voltage. Simply cut a hole between the floor and joists and drop through. The flange lip holds it in place.

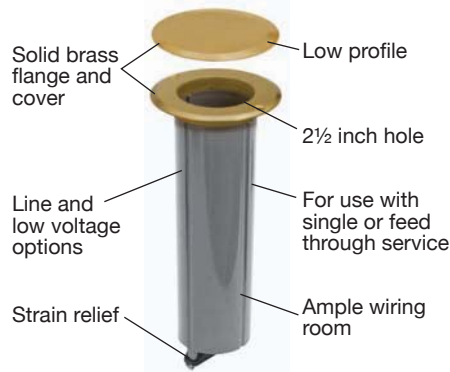

Floor Boxes For Wood Floors

Description	Material	Tamper-Resistant	Standard	Tamper-Resistant	Standard
Drop In Floor Box Mounts in 2½ inch hole opening. Includes solid brass cover, single tamper-resistant receptacle, optional device mounts for two (2) voice/data video ports. Suitable for feed through circuitry. Impact resistant box.	Solid Brass	RF151R	—	RF201R	—
Duplex Receptacle Floor Box Rated Includes steel box, duplex TR receptacle and cover.		RF6500BR	—	—	—
Single Receptacle Floor Box Rated Includes steel box, single receptacle and cover.	Brass	RF151TR	RF151	—	—
Single Receptacle Display Rated Receptacle and cover only, excludes box.	Brass	—	RF151D	—	—



Product Dimensions

Wood Floor Boxes

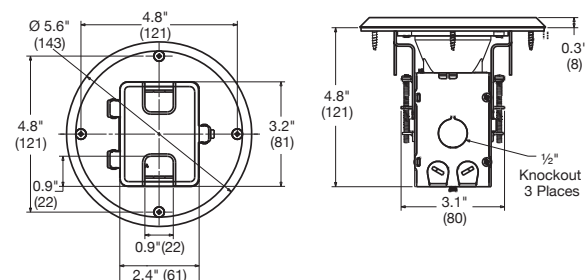

Drop-In Floor Box

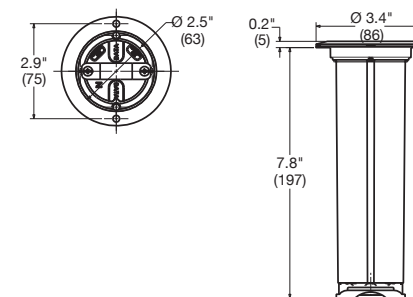

Dimensions in Inches (mm)

www.hubbell-wiring.com



Wiring Device-Kellems

V-23

tradeSELECT® Floor Boxes For Concrete Floors

Power Delivery



Residential Round Non-Metallic Floor Box offers an economical solution for electrical power or a combination of power and voice/data applications. Designed specifically for slab-on-grade installation. Quick and easy installation is assured using a push in place leveling system. UL Listed E92074.

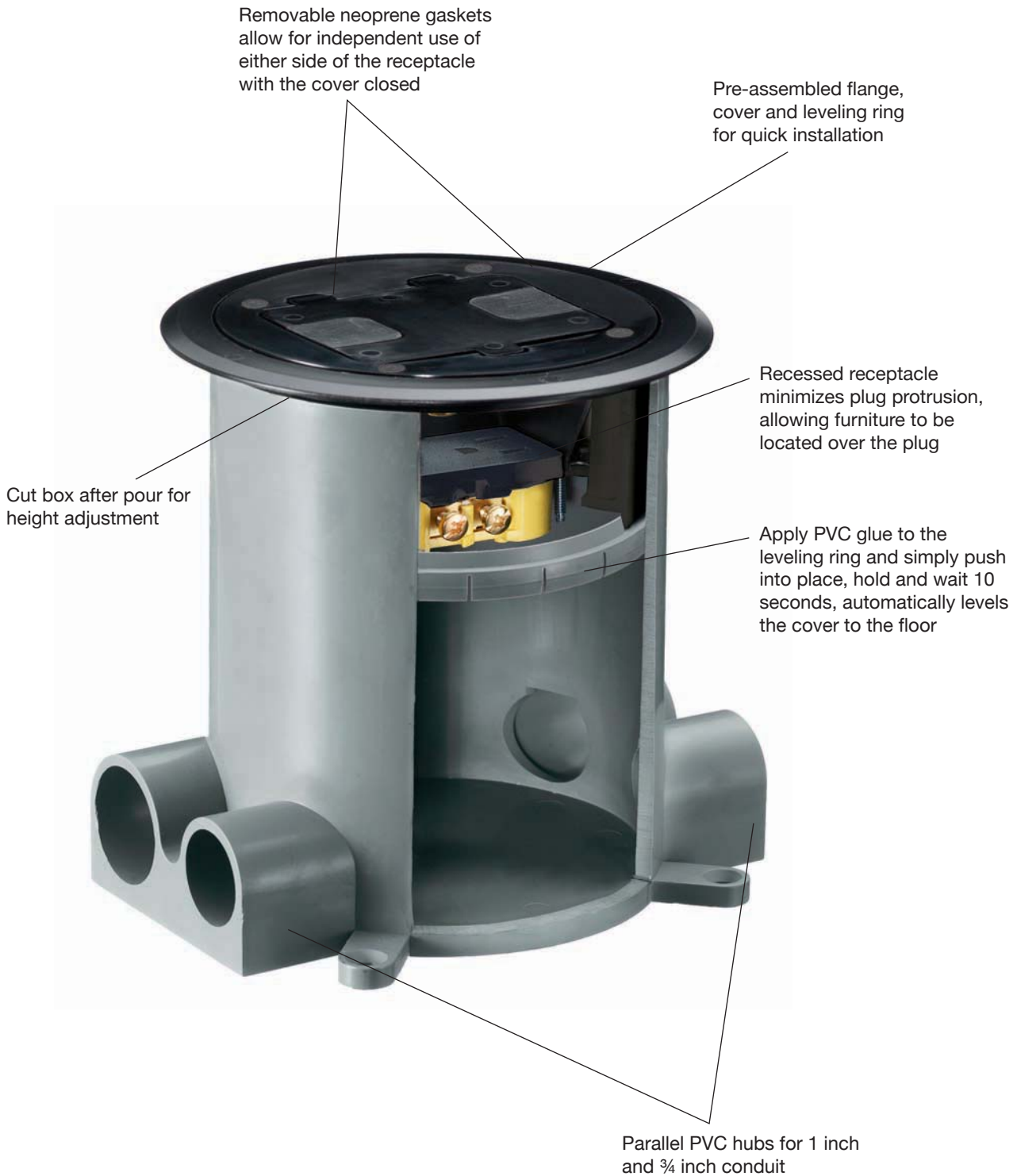

tradeSELECT® Floor Boxes For Concrete Floors

Power Delivery



After the box has been secured in concrete, cut for height, apply PVC glue and push the cover assembly into the box. No fasteners or adjustment screws required.

- 4 inch minimum concrete pour
- Recessed GFCI/Decorator opening
- Self height and leveling ring, no adjustments
- UL Listed E92074 Floor Box

Floor Boxes For Concrete Floors

Description	Rating	Material/Color	Catalog Number
Flange and Hinged Door Cover Assembly Includes duplex receptacle, gasket, floor leveling PVC ring, high impact and chemically resistant nylon. Factory pre-assembled for easy drop-in installation.	15A 125V NEMA 5-15R	Solid Brass	RF406BR
		Almond	RF406AL
		Black	RF406BK
		Gray	RF406GY
		Chestnut Brown	RF406BN
Flush cover		Solid Brass	RF409BR
PVC Floor Box with Concrete Protective Cover Accepts ¾ in. and 1.0 in. schedule 40 and schedule 80 PVC conduit. Includes round box (4 7/8 in. diameter x 6.0 in. deep), four reducers, closure plugs, and concrete cover with locator flag.		Gray	RF400
Hinged Nylon Replacement Door Cover Includes neoprene gasket to seal plug openings. Replacement cover for RF406 series.		Solid Brass	RF407BR
		Almond	RF407AL
		Black	RF407BK
Low Voltage Divider For use in PVC box RF400, when JLOAD® Multimedia Outlet is used.		Gray	RF408



RF406BK



RF400



RF407BK

JLOAD® Multimedia Outlet

Description	Material	 Tamper-Resistant Standard		 Tamper-Resistant Standard	
		RJ650ALTR	RJ650AL	RJ620ALTR	RJ620AL
JLOAD® Multimedia Outlet Specifically designed to provide power, Cat. 5e and coaxial in a single gang box. Requires Low Voltage Divider RF408 when used in PVC Box RF400. Perfect for HDTV and computer use where a combination of power and data are needed. Includes decorator frame, one Cat. 5e, one F-connector and one power receptacle 125V with voltage divider.	Almond	RJ650ALTR	RJ650AL	RJ620ALTR	RJ620AL
	Black	RJ650BKTR	RJ650BK	RJ620BKTR	RJ620BK
	Gray	RJ650GYTR	RJ650GY	RJ620GYTR	RJ620GY
	Ivory	RJ650ITR	RJ650I	RJ620ITR	RJ620I
	Light Almond	RJ650LATR	RJ650LA	RJ620LATR	RJ620LA
White	RJ650WTR	RJ650W	RJ620WTR	RJ620W	
JLOAD® Multimedia Outlet Includes decorator frame with two open ports for custom configuration and one power receptacle 125V with voltage divider.	Almond	RJ65ALTR	RJ65AL	RJ62ALTR	RJ62AL
	Black	RJ65BKTR	RJ65BK	RJ62BKTR	RJ62BK
	Gray	RJ65GYTR	RJ65GY	RJ62GYTR	RJ62GY
	Ivory	RJ65ITR	RJ65I	RJ62ITR	RJ62I
	Light Almond	RJ65LATR	RJ65LA	RJ62LATR	RJ62LA
	White	RJ65WTR	RJ65W	RJ62WTR	RJ62W



RF408



RJ650BK



RJ65BK

Note: * See Section X, page X-10 for TR description.

tradeSELECT® Under Cabinet/Counter Power Distribution



Power Delivery

These boxes comply with the NEC® for kitchen receptacles, with placement not more than 20 inches above the counter surface. They can also be placed under counter islands, not lower than 15 inches from the surface.

- Available with nylon or metal cover
- Custom configurable, accepts any decorator style device
- Mounting hardware included
- UL Listed E31999 and CSA Certified under cabinet boxes



Under Cabinet/Counter Power Distribution

Description	Slim Box Catalog Number	GFCI Fit Box Catalog Number
Stainless Steel	RU100SS	RU200SS
White Metal	RU100W	RU200W
White Nylon	RU170W*	RU270W*



RU100W

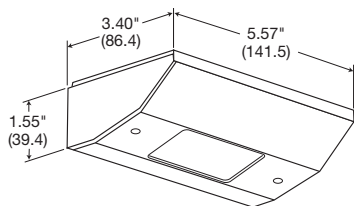

RU200SS

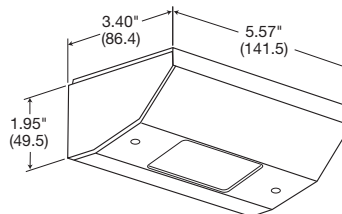

Note: * Steel box with nylon cover.

Vertical Mount

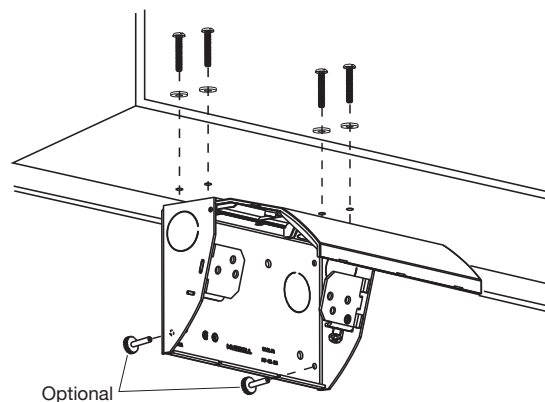

Horizontal Mount

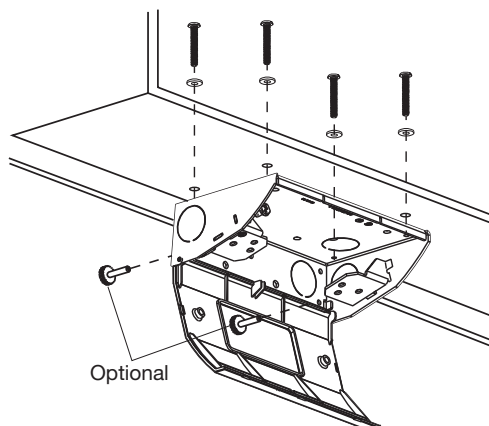

NEC® is a registered trademark of the National Fire Protection Association (NFPA).

tradeSELECT® JLOAD® Multimedia Outlet

Power Delivery



Make The Most Of A Perfect Location.

Install receptacles and voice/data devices exactly where they are needed, in the smallest space possible.

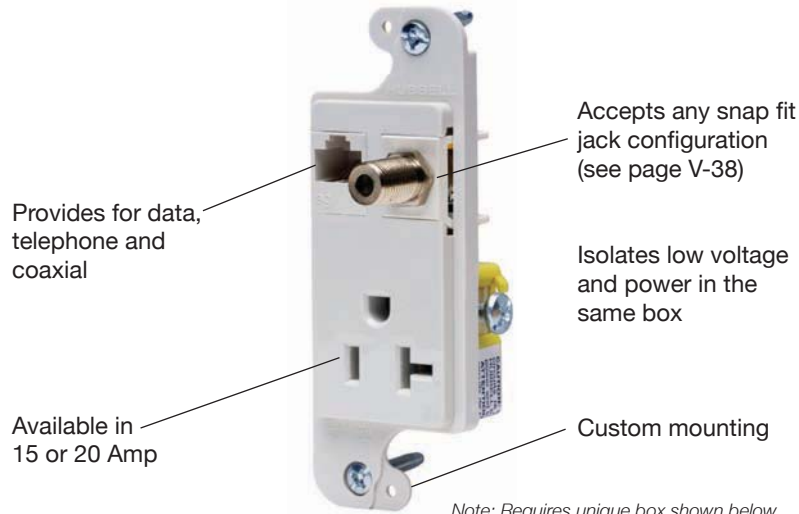

Note: Requires unique box shown below.

JLOAD® Multimedia Outlet

Description	Color	15A 125V NEMA 5-15R UL/CSA		20A 125V NEMA 5-20R UL/CSA	
		Tamper-Resistant	Standard	Tamper-Resistant	Standard
JLOAD® Multimedia Outlet, specifically designed to provide power, Cat. 5e and coaxial in a single gang box. Requires JLOAD® Multimedia Box RJ600. Perfect for HDTV and computer use where a combination of power and data are needed. Includes decorator frame, one Cat. 5e, one F-connector and one power receptacle 125V with voltage divider.	Almond Black Gray Ivory Light Almond White	RJ650ALTR RJ650BKTR RJ650GYTR RJ650ITR RJ650LATR RJ650WTR	RJ650AL RJ650BK RJ650GY RJ650I RJ650LA RJ650W	RJ620ALTR RJ620BKTR RJ620GYTR RJ620ITR RJ620LATR RJ620WTR	RJ620AL RJ620BK RJ620GY RJ620I RJ620LA RJ620W
JLOAD® Multimedia Outlet, includes decorator frame with two open ports for custom configuration and one power receptacle 125V with voltage divider.	Almond Black Gray Ivory Light Almond White	RJ65ALTR RJ65BKTR RJ65GYTR RJ65ITR RJ65LATR RJ65WTR	RJ65AL RJ65BK RJ65GY RJ65I RJ65LA RJ65W	RJ62ALTR RJ62BKTR RJ62GYTR RJ62ITR RJ62LATR RJ62WTR	RJ62AL RJ62BK RJ62GY RJ62I RJ62LA RJ62W
JLOAD® Multimedia Box, 3 inches deep with seven ½-inch knockouts, non-metallic sheathed cable clamps on each side. Screw in mounting to stud.	Steel	RJ600	RJ600	RJ600	RJ600

Note: * See Section X, page X-10 for TR description.

JLOAD® Dimensions

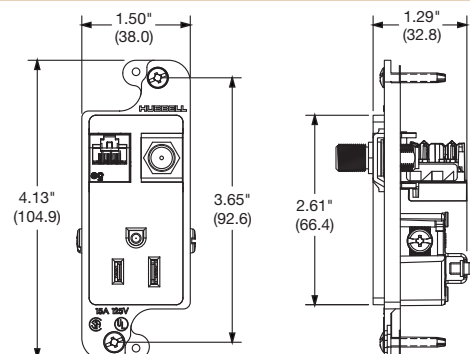

tradeSELECT®

Decorator Switches*Dimensions and Specifications*

- Smooth, quiet rocker action
- Self-grounding feature standard
- Ultrasonically welded cover and base provides maximum strength
- Push, back and side wiring
- Available colors: Almond, Black, Brown, Gray, Ivory, Light Almond and White

**RSD115W****Specifications****Switches**

Typical Specification — Catalog Number RSD115*

Description — Decorator series rocker switch

Type — Single Pole

Rating — 15A, 120-277V AC

Note: * Designates color: AL = Almond, BK = Black, Blank = Brown, GY = Gray, I = Ivory, LA = Light Almond, W = White.

Certification

- Listed to UL Standard 20
- CSA Certified

Components**Materials**

Base and body	PVC
Rocker	Polycarbonate
Terminals	Brass
Mounting strap	Galvanized steel
Contacts	Silver alloy
Movable contact arm	Copper alloy
Terminal screws	Steel

Performance**Electrical**

Dielectric voltage	Withstands 1,500V AC minimum for 1 minute
Max. working voltage	120V
Overload	1.5 times rating
Endurance	30,000 cycles minimum

Mechanical

Terminal accommodation	Back and side wire: #14 AWG min. - #12 AWG max. solid and stranded copper wire only; push wire: #14 AWG solid copper wire only
------------------------	--

Environmental

Flammability	UL V0
Operating temperatures	Maximum continuous 60°C; minimum -20°C (without impact)

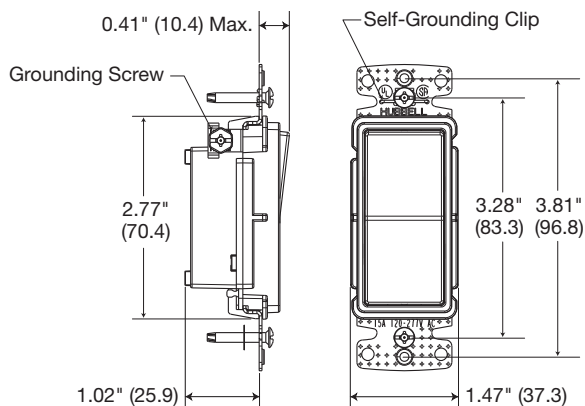
Product Dimensions**Single-Pole Decorator Switch**

Section V netSELECT®

Index

netSELECT®	Page
Structured Wiring	
In-Wall AV Delivery	V-30
HDMI Products	V-31
Advantages and Wiring Layout	V-32
Network Enclosures	V-33
Network Modules	V-34
Audio/Video Modules	V-35
Universal Consolidation Blocks, Patch Panels and Patch Cords.	V-36
Accessories.	V-37
Data Communications and Audio/Video	
Modular Snap Fit Jacks	V-38
Decorator Frames	V-39
Molded-In Voice/Data/Video	V-40
Molded-In Plates.	V-41
Telephone Wall Jacks	V-42

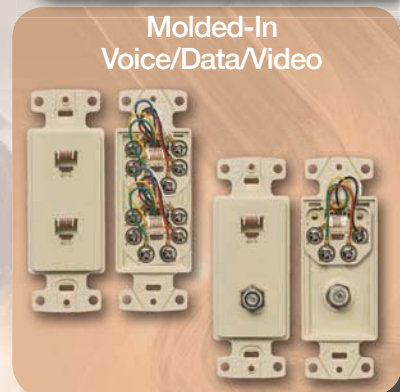
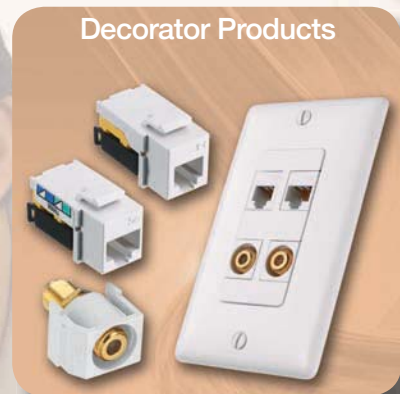

netSELECT® In-Wall AV Delivery

Structured Wiring



Hubbell's netSELECT® Flat Panel Television (FPTV) connection enclosure delivers high-density connectivity and power in the wall. This allows flat panel displays and interactive "smart" boards to sit flush against walls with no dangling cords. It quickly installs to studs or sheetrock without additional components or hardware.

- 18 Gauge white powder coated rugged steel base
- 2-Gang enclosure with 2 additional 3-Unit Hubbell iSTATION mounting locations
- Stud or sheetrock mounting integrated
- Supplied ABS trim ring quickly cleans up sheetrock rough-in
- Optional screw on cover reduces tampering
- cULus 1863 Listed

Rugged 18 Gauge Sheet Metal
Base White Powder Coat Finish

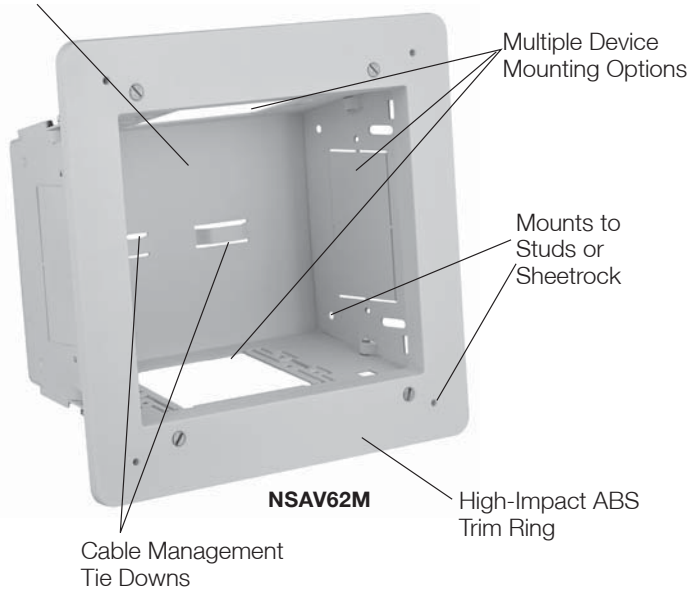

NSOKPS



NS801W



NSJ6W

FPTV Connection Enclosure

Description	Color	Catalog Number
2-Gang In-Wall Enclosure	White	NSAV62M
Steel Cover for NSAV6 series	White	NSAV6C

Power Kits

Description	Color	Catalog Number
Standard Power Kit	White	NSOKP
Surge Protected Power Kit	Blue	NSOKPS
1-Gang Decorator Plate	White	NP26W
1-Gang Hubbell iSTATION Plate	White	IMF1W
1-Gang 4-Port Keystone Plate	White	NSP14W

AV Connectors and Plates

Description	Color	Catalog Number
1-Port HDMI Frame	White	NS801W
2-Port HDMI Frame	White	NS802W
HDMI Snap Fit	Black	SFHCBK
F-Connector Snap Fit	White	NSF70W
USB A-to-B Snap Fit	White	SFUSBABW
Cat 6 Snap Fit Jack	White	NSJ6W

Note: See section P for other connector options.

netSELECT® HDMI Products

Structured Wiring



The AV Ceiling Enclosure is designed to work with active AV devices to integrate AV distribution, data connections and power in one location, providing a direct connection to a projector or a display device. The enclosure comes loaded with two Hubbell 20A duplex receptacles and a 2-gang RACO® box for installation convenience on the job site. An additional AV/data kit can be added or customized to address all connector, mounting and patching needs, reducing multiple pieces on site.

- Manage multiple applications inside one enclosure
- Flush mounted, white enclosure for consistent look when mounted in the ceiling
- Loaded with two Hubbell 20A duplex receptacles and a 2-gang back box
- All steel rugged construction provides the ultimate strength for installation



AVCE1H

AV Ceiling Enclosure

Description	Color	Catalog Number
AV Ceiling Enclosure	White	AVCE1H

Note: Enclosure Includes: Enclosure 24" x 12" x 8", (2) 20 amp duplex receptacles and 2-gang back box.

netSELECT® HDMI Decorator Frames deliver uncompromising digital audio and video wherever you need it. Unleash the full potential of your high definition display and audio installations.

- Third party tested for 1080p resolutions
- UL Listed - Communications Circuit Accessory and CSA Certified

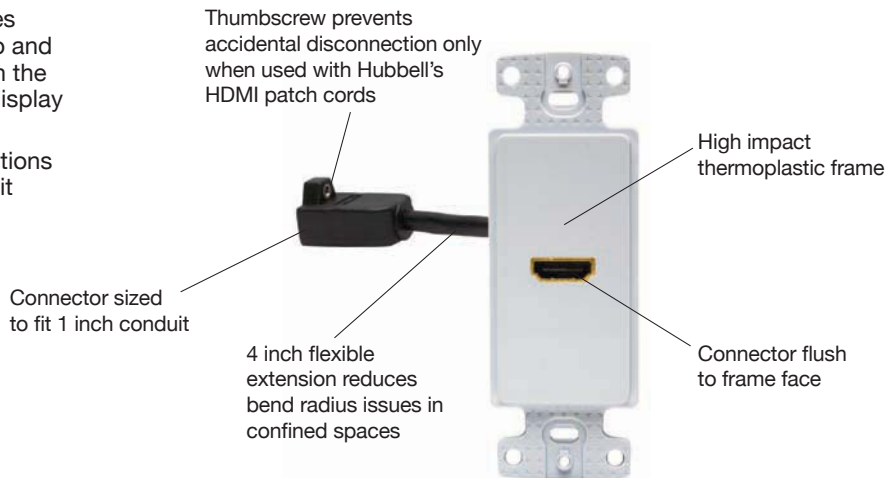

HDMI Products

Description	Color	1-Gang, 1-Port	1-Gang, 2-Port
HDMI, Decorator Frame, Female to Female	Almond	NS801AL	NS802AL
	Black	NS801BK	NS802BK
	Gray	NS801GY	NS802GY
	Ivory	NS801I	NS802I
	Light Almond	NS801LA	NS802LA
	White	NS801W	NS802W



NS801W



NS802W



HDP06BK

HDMI Cords

HDMI Device Patch Cords	
HDMI (24 AWG)	Catalog Number
3 ft.	HDPC03BK
6 ft.	HDPC06BK

Link Cords (Connector to Device)	
HDMI (24 AWG)	Catalog Number
XX ft.	HDLXXBK

Horizontal Cords (Connector to Connector)	
HDMI (24 AWG)	Catalog Number
XX ft.	HDHXXBK

Coupler Cords (Coupler to Device)	
HDMI (24 AWG)	Catalog Number
XX ft.	HDCXXBK

Note: XX = Length in feet. '10' = 10 ft., '15' = 15 ft., '20' = 20 ft., '25' = 25 ft., '30' = 30 ft., Black and Non-Plenum only.



netSELECT®

Advantages and Wiring Layout

Structured Wiring



- Share single analog, cable or DSL internet connection
- Local file access
- Shared peripherals
- Multiple telephone distribution
- Call handling (PBX)
- Video distribution
- Play games that allow multi-users
- Control home automation systems

Connect Your Home to Internet, Voice And Video Services

netSELECT® is an innovative network solution that's perfect for any home or small office. Specifically positioned as the voice/data segment for the Residential brand, the netSELECT® System satisfies the need for a dependable, flexible system that can accommodate all of today's fast-changing voice, data and video requirements. This cost-effective solution incorporates all the quality you'd expect from Hubbell. Built-in flexibility makes it easy to upgrade and keep pace with evolving technologies.



Today's Communications Entail A Lot More Than Just Talking. netSELECT® Keeps You Connected—Internet, Voice, Data and Entertainment

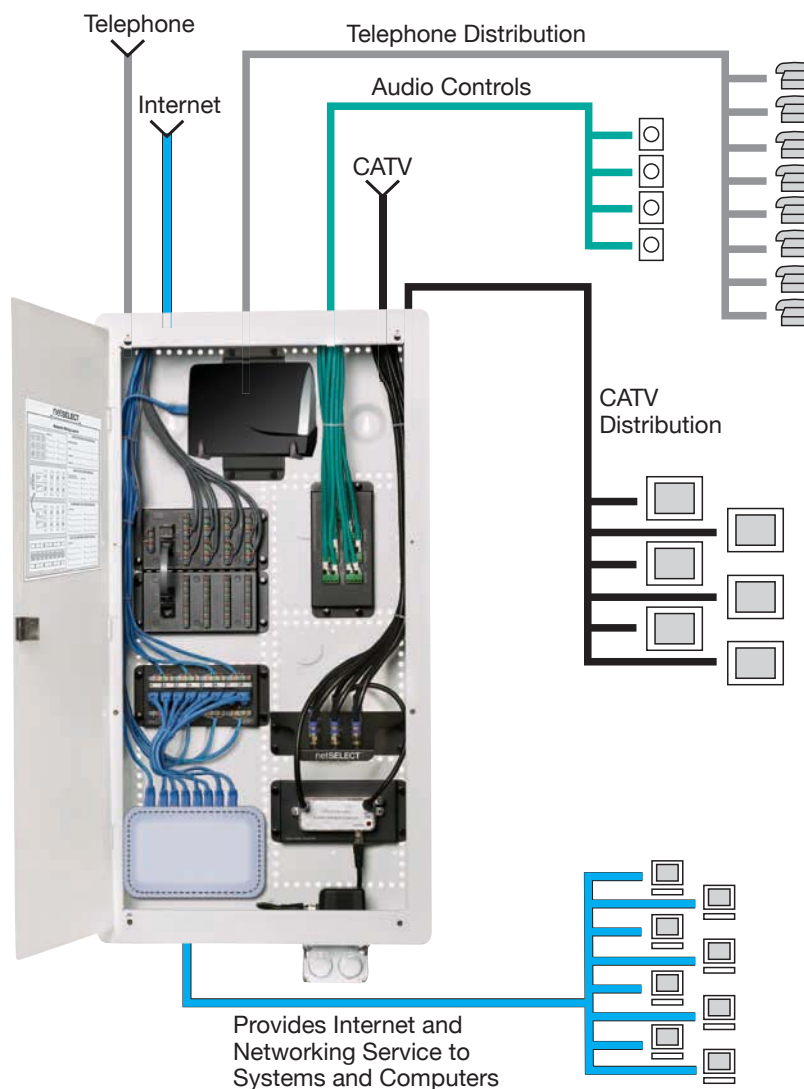

- Flush or surface mount enclosure (hardware provided)
- Hinged cover can be mounted to swing from either side
- Integral trim ring hides rough-in hole in except NSOBOX48 sheet rock providing a finished appearance
- Horizontal and vertical module mounting holes for maximum flexibility
- Unique 89D bracket mounting holes allow easy mounting of 66 blocks and peripherals
- Provisions to mount optional duplex power and lock kit available
- Integral cable management slots and tie-wraps provided to help dress cable runs
- Additional nylon push pins provided to assist module mounting
- Material: 20-18 gauge steel
- Finish: white, powder coat
- UL and cULus Listed 1863

Network Enclosures

Description		Number of	
		Module Placement	Catalog Number
Pre-configured Network System Basic home network kit includes: One box with hinged cover NSOBOX14, One primary 8-port telephone module NSOPTM8, One four way coaxial splitter module NSOVDM4		—	NSOBNK14
10 Inch Network Enclosure for MDU and Modular Applications Dimensions: 14.38 in. W x 10.0 in. H x 3.96 in. D Knock-outs: Top: four 1½ in. N.P.T. or completely open combo; Bottom: four 1½ in. N.P.T. or completely open combo; Back: none	with Hinged Cover with Panel Cover 10"H Box only Hinged Door Panel Cover	3	NSOBOX10 NSOBOX10BC NSOBOX10B NSOBOX10D NSOBOX10C
14 Inch Network Enclosure Dimensions: 14.38 in. W x 14 in. H x 3.96 in. D Knock-outs: Top: two 1 in. Dia. and three 1½ in. N.P.T. combo; Bottom: one 1 in. Dia. and one 1½ in. N.P.T. combo; Back: two ¾ in. N.P.T.	with Hinged Cover with Panel Cover 14"H Box only Hinged Door Vertical Door Panel Cover 2"D Extension Bracket with ventilation and WiFi KOs	5	NSOBOX14 NSOBOX14BC NSOBOX14B NSOBOX14D NSOBOX14DL NSOBOX14C NSOBOX14X2
28 Inch Network Enclosure Dimensions: 14.38 in. W x 28 in. H x 3.96 in. D Knock-outs: Top: five 1½ in. N.P.T.; Bottom: two power kit knockouts; Back: four ¾ in. N.P.T.	with Hinged Cover with Panel Cover 28"H Box only Hinged Door Vertical Door* Panel Cover 2"D Extension Bracket with ventilation and WiFi KOs	11	NSOBOX28 NSOBOX28BC NSOBOX28B NSOBOX28D NSOBOX28DL NSOBOX28C NSOBOX28X2
48 Inch Network Enclosure Dimensions: 14.38 in. W x 48 in. H x 3.96 in. D Knock-outs: Top: five 1½ in. N.P.T.; Bottom: two power kit knockouts; Back: none	with Hinged Cover	21	NSOBOX48



NSOBOX10



NSOBOX14



NSOBOX28

Note: For custom installs, REKHS is also available. See section P for ordering information.
* Door covers rough-in, no trim ring provided.

netSELECT® Network Modules

Structured Wiring



netSELECT® Modular Components enable the designer to select performance requirements specifically for the application. Modules snap horizontally or vertically into the enclosures for maximum flexibility and optimum space usage.

- Dimensions: 6.47 inch W x 2.95 inch H, except NSOMTM24 6.47 inch W x 6.00 inch H
- Meets FCC Part 68 standard
- Finish: black, powder coat
- Material: 18 gauge steel or high impact plastic
- UL and cULus Listed 1863
- All data and phone modules 568A wired

Network Modules



NSOTVM6



NSOPTM8



NSOETM8



NSODM8



NSOMTM24



NSO6P1DM

Description	Units	Catalog Number
Combo Module Complete Home Network Combo Module 6-Port Telephone Panel and 6-Port Coaxial Splitter with Optional 6-Port Cat. 5e Panel Provides voice, video, and data distribution in a space efficient package. Perfect for use with NSOBOX10 and NS790xx plates to quickly establish a comprehensive home network.	3	
6-Port Telephone and Video 6-Port Telephone, Video and Category 5e 6-Port Category 5e Data Upgrade Kit		NSOTVM6 NSOTVDM6 NSODK6
Primary Telephone Module, 8-Port Supports 8 phone outlets with up to 4 incoming lines for voice, fax or modem applications in a protected PCB module. Pre-mounted push pins snap the module quickly into place. RJ31X interface jack included for security system connection. RJ45 jack interfaces with optional NSOETM8 Telephone Expansion module for additional extensions.	1	NSOPTM8
Expansion Telephone Module, 8-Port Adds an additional 8 phone outlets with up to 4 incoming lines when used with the primary telephone module. Pre-mounted push pins snap the module quickly into place. Includes RJ45 jumper cord to connect with NSOPTM8 Primary Telephone module.	1	NSOETM8
Category 5e Data Module, 8-Port Supports Gigabit Ethernet for up to 8 Category 5e data lines with front 110 Punch-Down terminations in a protected PCB module. Pre-mounted push pins snap the module quickly into place.	1	NSODM8
Category 6 Data Module, 8-Port Supports enhanced transmission speeds beyond gigabit ethernet. Future proof for tomorrows applications.		NSODM8C6
Multiport Patchable Telecom Module Terminates lines via modular plug to accommodate flexibility, by changing plug locations. Reconfigure where phone lines go at the panel level. Allows data lines to be converted to voice, with the move of a patch cord. Includes nine RJ45 jumper cords.	2	NSOMTM24
Combination Module 6-Port Telephone and 1-Port Data Provides basic telephone and data delivery in a small package. Allows data lines to be converted to voice, with the move of a patch cord.	1	NSO6P1DM

netSELECT® Video Modules support bidirectional signal by splitting to 4, 6, or 8 separate work areas. Pre-mounted push pins snap the module quickly into place.

- Dimensions for VAMP, AM8 and BM: 6.47 in. W x 2.95 in. H
- Dimensions for video splitters: 6.47 in. W x 2.09 in. H x 3.20 in. D
- Finish: black, powder coat
- UL and cULus Listed 1863

Audio/Video Modules

Description	Units	Catalog Number
4-Way Coaxial Splitter Modules, One Incoming Line, Four Outgoing 1 Ghz, Basic Unit 2.3 Ghz, Enhanced Capability	1	NSOVM4 NSOVM42G
6-Way Coaxial Splitter Modules, One Incoming Line, Six Outgoing 1 Ghz, Basic Unit 2.3 Ghz, Enhanced Capability	1	NSOVM6 NSOVM62G
8-Way Coaxial Splitter Modules, One Incoming Line, Eight Outgoing 1 Ghz, Basic Unit 2.3 Ghz, Enhanced Capability	1	NSOVM8 NSOVM82G
Fixed Video Amplifier Module, 10dB 120 volt rated 240 volt rated Provides video signal amplification for incoming cable feeds recommended for use when more than four outputs are installed or when signal level is low. Provides 10dB forward path gain and supports current digital cable systems and modems with a passive return. Pre-mounted push pins snap the module quickly into place. Includes RG-59 cable jumper to connect amplifier to passive video splitter.	1	NSOVAMP NSOVAMP240
8 Room Audio Module, Distributes audio from an amplifier to matching volume controllers. Supports up to eight rooms of audio. Power handling - 200W RMS@20° C. Requires impedance matching volume controls, see page V-67.	1	NSOAM8
Blank Module Plate Allows mounting of active components (i.e. switches, routers) or other devices (66 blocks, audio components) onto a modular platform. Can be custom drilled or used with two self-adhesive VELCRO® strips included to mount components onto module. Pre-mounted push pins snap the module quickly into place.	1	NSOBM



NSOVM4



NSOVM6



NSOVM8



NSOVAMP



NSOAM8



NSOBM

netSELECT®

Universal Consolidation Blocks, Patch Panels and Patch Cords

Structured Wiring



netSELECT® Patch Panels are excellent for designing rack systems for telephone, data and AV systems. Consolidation Blocks are ideal for small user count configurations that mount in or on the wall.

- Meets ANSI/TIA - Category 6 and Category 5e standards
- cULus Listed

Universal Consolidation Blocks and Patch Panels

Description	Catalog Number
Category 5e 12-Port Universal Consolidation Block, 89D Bracket Mount	NS5E12U
Category 6 12-Port Universal Consolidation Block, 89D Bracket Mount	NS612U
Category 5e Universal Patch Panel 24-port, 1.75 inch H, 1 Rack Unit 48-port, 3.50 inch H, 2 Rack Units	NS5E24U NS5E48U
Category 6 Universal Patch Panel 24-port, 1.75 inch H, 1 Rack Unit 48-port, 3.50 inch H, 2 Rack Units	NS624U NS648U



NS5E12U



NS612U



NS5E24U



NS5E48U



NS624U



NS648U

netSELECT® Patch Cords allow for quick change of voice/data lines with insertion of modular plugs.

- Meets and exceeds ANSI/TIA - Category 6 and Category 5e standards
- UL and cUL Listed

Universal Patch Cords, Category 6 and Category 5e

Description	Color	1-Foot	3-Foot	5-Foot	7-Foot	10-Foot	15-Foot	20-Foot	25-Foot
Cat. 5e Patch Cord	Blue	HC5EB01	HC5EB03	HC5EB05	HC5EB07	HC5EB10	HC5EB15	HC5EB20	HC5EB25
	Gray	HC5EGY01	HC5EGY03	HC5EGY05	HC5EGY07	HC5EGY10	HC5EGY15	HC5EGY20	HC5EGY25
	Yellow	HC5EY01	HC5EY03	HC5EY05	HC5EY07	HC5EY10	HC5EY15	HC5EY20	HC5EY25
	Red	HC5ER01	HC5ER03	HC5ER05	HC5ER07	HC5ER10	HC5ER15	HC5ER20	HC5ER25
Cat. 6 Patch Cord	Blue	HC6B01	HC6B03	HC6B05	HC6B07	HC6B10	HC6B15	HC6B20	HC6B25
	Gray	HC6GY01	HC6GY03	HC6GY05	HC6GY07	HC6GY10	HC6GY15	HC6GY20	HC6GY25
	Yellow	HC6Y01	HC6Y03	HC6Y05	HC6Y07	HC6Y10	HC6Y15	HC6Y20	HC6Y25
	Red	HC6R01	HC6R03	HC6R05	HC6R07	HC6R10	HC6R15	HC6R20	HC6R25



netSELECT®
Accessories
Structured Wiring



netSELECT® Accessories enhance system capabilities. Volume controls expand home audio applications. Cabinet mounted receptacle kits provide convenience power to the enclosure.

- Audio controls available in slide or rotary
- Receptacles available in surge and standard kits

Accessories

Description	Color	Catalog Number
Slide Audio Volume Controller, Decorator Styling, Power handling - 70W RMS@20° C. Impedance matching for up to 8 pairs of speakers. Includes both ivory and white slides and frames.	Ivory/White	NSOSAVC
Rotary Audio Volume Controller Power handling - 70W RMS@20° C. Impedance matching for up to 8 pairs of speakers. Includes both ivory and white knobs and frames.	Ivory/White	NSORAVC
Standard Power Kit, Includes duplex receptacle 15A 125V NEMA 5-15R, electrical steel box and wallplate.		NSOKP
Surge Suppression Power Kit, Includes surge receptacle 15A 125V NEMA 5-15R, 240 Joules/15,000A protection per mode, electrical steel box and wallplate.		NSOKPS
Chromed Steel Lock Kit, Includes two keys. Eliminates unwanted tampering.		FLOCK1
Panel Bracket Adapter, For use with Adapter Panels shown below, and FSP series modules in section P, page 16. Snap mounts into structured cabling enclosures.		NSOFSB
F-Connector Adapter Panel, with Six Populated Coaxial Connectors.		FSPFP6X
Keystone Adapter Panel, with Six Blank Openings for jacks and snap fits.		FSPHD6X
Antenna Kit.		NSOKA



NSOSAVC



NSORAVC



NSOKPS



FLOCK1



NSOFSB



FSPFP6X



FSPHD6X



NSOKA

netSELECT® Modular Snap Fit Jacks

Decorator Products



Customize the jack selections and look

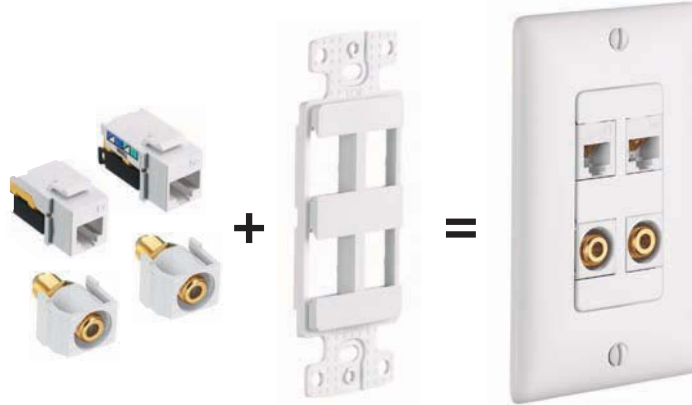

Molded-In Voice/Low-Speed Data

Description	Modular Snap Fit Cat. 6 Jack	Modular Snap Fit Cat. 5e Jack	Modular Snap Fit USOC Jack
Color			
Almond	NSJ6AL	NSJ5EAL	NSJUAL
Black	NSJ6BK	NSJ5EBK	NSJUBK
Blue	NSJ6B	NSJ5EB	NSJUB
Gray	NSJ6GY	NSJ5EGY	NSJUGY
Green	NSJ6GN	NSJ5EGN	NSJUGN
Ivory	NSJ6I	NSJ5EI	NSJUI
Light Almond	NSJ6LA	NSJ5ELA	NSJULA
Orange	NSJ6OR	NSJ5EOR	NSJUOR
Red	NSJ6R	NSJ5ER	NSJUR
White	NSJ6W	NSJ5EW	NSJUW
Yellow	NSJ6Y	NSJ5EY	NSJUY

Audio/Video Connectors - Standard Bulkhead

Description	Gold F-Type Coupler Bulkhead, Female to Female	Nickel F-Type Coupler Bulkhead, Female to Female	RCA Gold Pass Through, Female to Female, Red Interior	RCA Gold Pass Through, Female to Female, White Interior	RCA Gold Pass Through, Female to Female, Yellow Interior	RCA Gold Pass Through, Female to Female, Blue Interior	RCA Gold Pass Through, Female to Female, Green Interior
Color							
Almond	SFFGAL	NSF70AL	SFRCRFFAL	SFRCWFFAL	SFRCYFFAL	SFRCBFFAL	SFRCGNFFAL
Black	SFFGBK	NSF70BK	SFRCRFFBK	SFRCWFFBK	SFRCYFFBK	SFRCBFFBK	SFRCGNFFBK
Gray	SFFGGY	NSF70GY	SFRCRFFGY	SFRCWFFGY	SFRCYFFGY	SFRCBFFGY	SFRCGNFFGY
Ivory	SFFGEI	NSF70I	SFRCRFFEI	SFRCWFFEI	SFRCYFFEI	SFRCBFFEI	SFRCGNFFEI
Light Almond	SFFGLA	NSF70LA	SFRCRFFLA	SFRCWFFLA	SFRCYFFLA	SFRCBFFLA	SFRCGNFFLA
White	SFFGW	NSF70W	SFRCRFFW	SFRCWFFW	SFRCYFFW	SFRCBFFW	SFRCGNFFW

Audio/Video Connectors - Recessed

Description	Gold F-Type Coupler Bulkhead, Female to Female	RCA Gold Pass Through, Female to Female, Red Interior	RCA Gold Pass Through, Female to Female, White Interior	RCA Gold Pass Through, Female to Female, Yellow Interior	RCA Gold Pass Through, Female to Female, Blue Interior	RCA Gold Pass Through, Female to Female, Green Interior	Blank Insert
Color							
Almond	SFGRFAL	SFRCRRAL	SFRCWRAL	SFRCYRAL	SFRCBRAL	SFRCGNRAL	SFSBAL10*
Black	SFGRFBK	SFRCRRBK	SFRCWRBK	SFRCYRBK	SFRCBRBK	SFRCGNRBK	SFSBBK10*
Gray	SFGRFGY	SFRCRRGY	SFRCWRGY	SFRCYRGY	SFRCBRGY	SFRCGNRGY	SFSBGY10*
Ivory	SFGRFEI	SFRCRRREI	SFRCWREI	SFRCYREI	SFRCBREI	SFRCGNREI	SFSBEI10*
Light Almond	SFGRFLA	SFRCRRRLA	SFRCWRRLA	SFRCYRLA	SFRCBRRLA	SFRCGNRLA	SFSBLA10*
White	SFGRFW	SFRCRRRW	SFRCWRW	SFRCYRW	SFRCBRW	SFRCGNRW	SFSBW10*

Note: * Sold in a package of 10. Order 1 to receive a bag of 10 blanks.

netSELECT® Decorator Frames

Decorator Products

Features

Decorator frames provide a stylized look for that finishing touch. This allows all devices to match. Multimedia jacks insert into frame for custom configuration.

- Elongated strap for better wall box mounting
- High impact-resistant thermoplastic frame
- UL Listed 1863 - Communication Circuit Accessory and CSA Certified

Decorator Frames



Color	1-Gang, 2-Port	1-Gang, 3-Port	1-Gang, 4-Port	1-Gang, 6-Port	1-Gang, Adapter .406" (10.30) Dia. Hole*	1-Gang, Adapter Blank**
Almond	NS612AL	NS613AL	NS614AL	NS616AL	NS621AL	NS620AL
Black	NS612BK	NS613BK	NS614BK	NS616BK	—	—
Gray	NS612GY	NS613GY	NS614GY	NS616GY	—	—
Ivory	NS612I	NS613I	NS614I	NS616I	NS621I	NS620I
Light Almond	NS612LA	NS613LA	NS614LA	NS616LA	NS621LA	NS620LA
White	NS612W	NS613W	NS614W	NS616W	NS621W	NS620W

Note: * For use with rotary dimmers or to pull through AV or telephone cable.

** To fill an extra decorator opening or to create customized openings.

Multimedia Face Plates

Description	1-Gang, 1-Port Plate		1-Gang, 2-Port Plate		1-Gang, 3-Port Plate	
	Standard (4.63" x 2.88")	Mid-Size (4.88" x 3.13")	Standard (4.63" x 2.88")	Mid-Size (4.88" x 3.13")	Standard (4.63" x 2.88")	Mid-Size (4.88" x 3.13")
Almond	NSP11AL	NSP101AL	NSP12AL	NSP102AL	NSP13AL	NSP103AL
Black	NSP11BK	NSP101BK	NSP12BK	NSP102BK	NSP13BK	NSP103BK
Gray	NSP11GY	NSP101GY	NSP12GY	NSP102GY	NSP13GY	NSP103GY
Ivory	NSP11I	NSP101I	NSP12I	NSP102I	NSP13I	NSP103I
Light Almond	NSP11LA	NSP101LA	NSP12LA	NSP102LA	NSP13LA	NSP103LA
White	NSP11W	NSP101W	NSP12W	NSP102W	NSP13W	NSP103W

Description	1-Gang, 4-Port Plate		1-Gang, 6-Port Plate		2-Gang, 4-Port Plate		2-Gang, 6-Port Plate	
	Standard (4.63" x 2.88")	Mid-Size (4.88" x 3.13")	Standard (4.63" x 2.88")	Mid-Size (4.88" x 3.13")	Standard (4.63" x 4.69")	Standard (4.63" x 4.69")	Standard (4.63" x 4.69")	Standard (4.63" x 4.69")
Almond	NSP14AL	NSP104AL	NSP16AL	NSP106AL	NSP24AL	NSP26AL	NSP24AL	NSP26AL
Black	NSP14BK	NSP104BK	NSP16BK	NSP106BK	NSP24BK	NSP26BK	NSP24BK	NSP26BK
Gray	NSP14GY	NSP104GY	NSP16GY	NSP106GY	NSP24GY	NSP26GY	NSP24GY	NSP26GY
Ivory	NSP14I	NSP104I	NSP16I	NSP106I	NSP24I	NSP26I	NSP24I	NSP26I
Light Almond	NSP14LA	NSP104LA	NSP16LA	NSP106LA	NSP24LA	NSP26LA	NSP24LA	NSP26LA
White	NSP14W	NSP104W	NSP16W	NSP106W	NSP24W	NSP26W	NSP24W	NSP26W

netSELECT® Molded-In Voice/Data/Video



Data Communications and Audio/Video

Features

Designed to complement decorator styling, these jacks offer voice and Cat. 5e devices to fit within a decorator wallplate.

- High impact-resistant thermoplastic frame
- Meets FCC part 68
- UL Listed 1863 - Communication Circuit Accessory and CSA Certified

Molded-In Voice/Low-Speed Data

Description	Decorator Frame, One RJ11 Jack, 6-Position, 4-Conductor	Decorator Frame, One RJ11 Jack, 6-Position, 6-Conductor	Decorator Frame, Duplex RJ11 Jacks, 6-Position, 6-Conductor	Decorator Frame, One Cat. 5e 110 Punch-Down, One RJ11 Jack, 6-Position, 4-Conductor
Termination	Screw Terminations	Screw Terminations	Screw Terminations	Screw Terminations
Color				
Almond	NS770AL	NS771AL	NS772AL	NS784AL
Black	NS770BK	—	—	NS784BK
Brown	NS770	NS771	—	NS784
Gray	NS770GY	—	—	NS784GY
Ivory	NS770I	NS771I	NS772I	NS784I
Light Almond	NS770LA	NS771LA	NS772LA	NS784LA
White	NS770W	NS771W	NS772W	NS784W

Features

Coaxial video and combination jacks complement multimedia needs in a 1-gang decorator opening.

- High impact-resistant thermoplastic frame
- Jacks meet FCC part 68
- UL Listed 1863 - Communication Circuit Accessory and CSA Certified

Molded-In Voice/Low-Speed Data

Description	Decorator Frame, Single F-Type Coupler Bulkhead, Female to Female	Decorator Frame, Duplex F-Type Coupler Bulkhead, Female to Female	Decorator Frame, One RJ11 Jack, 6-Position, 4-Conductor, One F-Type Coupler Bulkhead, Female to Female	Decorator Frame, One Cat. 5e 110 Punch-Down, One F-Type Coupler Bulkhead, Female to Female
Termination	Screw Terminations	Screw Terminations	Screw Terminations	Screw Terminations
Color				
Almond	NS780AL	NS782AL	NS783AL	NS785AL
Black	—	—	—	NS785BK
Brown	—	—	—	NS785
Gray	—	—	—	NS785GY
Ivory	NS780I	NS782I	NS783I	NS785I
Light Almond	NS780LA	NS782LA	NS783LA	NS785LA
White	NS780W	NS782W	NS783W	NS785W



netSELECT®
Molded-In Plates



Data Communications and Audio/Video

Features

Designed for voice, these devices provide an economical alternative to wall phone outlet placement.

- High impact-resistant thermoplastic plate
- Convenient screw down terminals
- Meets FCC part 68
- UL Listed 1863 - Communication Circuit Accessory and CSA Certified

Molded-In Plates for Voice

Description	1-Gang Plate, One RJ11 Jack, 6-Position, 4-Conductor, Screw Terminations		1-Gang Plate, One RJ11 Jack, 6-Position, 6-Conductor, Screw Terminations		1-Gang Plate, Duplex RJ11 Jacks, 6-Position, 4-Conductor, Screw Terminations		1-Gang Plate, Duplex RJ11 Jacks, 6-Position, 6-Conductor, Screw Terminations	
Color	Standard	Mid-Size	Standard	Mid-Size	Standard	Mid-Size	Standard	Mid-Size
Almond	NS730AL	NS735AL	NS732AL		NS742AL	—	NS744AL	
Brown	NS730	NS735	NS732		—	—	—	
Ivory	NS730I	NS735I	NS732I		NS742I	NS745I	NS744I	
Light Almond	NS730LA	NS735LA	NS732LA		NS742LA	—	—	
White	NS730W	NS735W	NS732W		NS742W	NS745W	NS744W	

Molded-In Plates for Voice and CATV/Satellite

Description	1-Gang Plate, One F-Type Coupler Bulkhead, Female to Female, One RJ11 Jack, 6-Position, 6-Conductor		1-Gang Plate, One F-Type Coupler Bulkhead, Female to Female, One RJ11 Jack, 6-Position, 4-Conductor		1-Gang Plate, One F-Type Coupler Bulkhead, Female to Female		1-Gang Plate, Duplex F-Type Coupler Bulkhead, Female to Female	
Color	Standard	Mid-Size	Standard	Mid-Size	Standard	Mid-Size	Standard	Mid-Size
Almond	NS748AL	NS755AL	NS747AL		NS750AL	NS751AL	NS752AL	
Ivory	NS748I	NS755I	NS747I		NS750I	NS751I	NS752I	
Light Almond	NS748LA	NS755LA	NS747LA		NS750LA	NS751LA	NS752LA	
White	NS748W	NS755W	NS747W		NS750W	NS751W	NS752W	

Description	1-Gang Plate, One Cat. 5e 110 Punch-Down One RJ11 Jack, 6-Position, 4-Conductor One F-Type Coupler Bulkhead, Female to Female	
Color	Standard	Mid-Size
Almond	NS790AL	
Black	NS790BK	
Brown	NS790	
Gray	NS790GY	
Ivory	NS790I	
Light Almond	NS790LA	
White	NS790W	



netSELECT®

Telephone Wall Jacks





Data Communications and Audio/Video

Features

Designed for voice applications, these jacks provide an economical alternative to basic wall mount and performance needs.

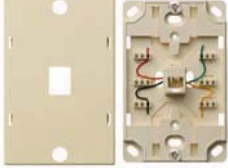
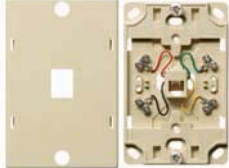
- Available in high impact-resistant thermoplastic or stainless steel
- Meets FCC part 68
- UL Listed 1863 - Communication Circuit Accessory and CSA Certified

Telephone Wall Jacks





Description	Wall Phone Jack Quick Connect, 6-Position, 4-Conductor, Punch-Down Termination Tool Included	Wall Phone Jack, 6-Position, 4-Conductor, Screw Terminations	Wall Phone Jack, 6-Position, 6-Conductor, Screw Terminations
Color			
Almond	NS721AL	NS722AL	NS725AL
Ivory	NS721I	NS722I	NS725I
Light Almond	—	—	NS725LA
White	NS721W	NS722W	NS725W
Description	Wall Phone Jack Quick Connect, 6-Position, 4-Conductor, Punch-Down Termination Tool Included	Wall Phone Jack, 6-Position, 4-Conductor, Screw Terminations	
Color			
Stainless Steel	NS723SS	NS726SS	

Features

Telephone surface mount jacks are available in 4- or 6-conductor configurations for voice. Alternatively, multimedia surface mount boxes can be custom loaded for computer and media use.

- High impact-resistant thermoplastic
- Mounts using screws or double sided tape (both included)
- Meets FCC part 68
- UL Listed 1863 - Communication Circuit Accessory and CSA Certified

Telephone Wall Jacks

Description	Telephone Surface Mount Jack, 6-Position, 4-Conductor, Screw Terminations	Telephone Surface Mount Jack, 6-Position, 6-Conductor, Screw Terminations	Multimedia 1-Port Surface Mount Box, Jack Not Included	Multimedia 2-Port Surface Mount Box, Jacks Not Included
Color				
Ivory	NS760I	NS761I	ISM1EI*	ISM2EI*
White	NS760W	NS761W	ISM1W*	ISM2W*

Note: * cULus Listed 1863 - Communication Circuit Accessory. Use multimedia jacks and AV connectors, see section P for complete list.