

LED RETROFIT FOR FLUORESCENT VAPOR TIGHT LUMINAIRES



Approvals:
UL1598 and UL1598C
Follows applicable Canadian standards
CSA C22.2 No. 250.0 and TIL B-79A

ecofit

DESCRIPTION

Easily convert a fluorescent vapour tight fixture to led with our innovative Retrofit Kit. A perfect upgrade option where cost savings, energy savings and long life are critical. Available for existing gullwing and flat pan fluorescent fixtures.

FEATURES

- The RETVP vapor proof LED retrofit kit delivers approximately 5000 lumens, while achieving over 120lm/W. (Condition of existing fluorescent luminaires may have varying impacts on delivered lumen levels).
- This series is available in neutral 4000K temperatures with 0-10V dimming wires inside the fixture ready to be connected.
- White post painted UV stabilized steel flat gear tray
- 80+ CRI
- Compatible with AIMLITE, STANPRO, STANDARD, RAB, LITELINE, BEGHELLI, THOMAS and BETTS, EMERGI-LITE LUMACELL, READYLITE fluorescent vapour tights. Refer to compatibility charts for more details to choose option 1 or option 2.
- The RETVP comes with frosted lenses over LED strips creating diffused uniform lighting, mimicking the look of fluorescent tubes and avoiding glare from LED.
- Easy installation in 5 min.
- Ambient temperature: -20°C to +35°C
- Colour consistency (SDCM) is 3 step MacAdam ellipse
- Meets requirements of ICES-005 issue 4 for class A products

AIMLITE ADVANTAGE

Installation

Retrofitting an existing fixture can easily save 70% to 80% installation time when compared to installing a new LED fixture.

Only takes 5 minutes to install!

Saves considerable installation time varying on type of mounting and application environment (must not only consider installation time of a new fixture but also removal time required of an existing fixture)

Less Waste and more Cost savings

Can you imagine the environmental impact of disposing of all perfectly functional fixtures in our landfills?

Along with reducing your environmental footprint, a retrofit is substantially more cost effective than a complete new fixture and avoids potential additional disposal fees and hassles.

Energy Savings

40W LED Watts replacing 2 lamp T8 FLUO 32Watts 12 hrs/day 365 days/yr

Cost / kw/h	Savings per year / fixture
\$0.06	\$4.47
\$0.08	\$5.96
\$0.10	\$7.45
\$0.12	\$8.94
\$0.14	\$10.42
\$0.16	\$11.91
\$0.18	\$13.40
\$0.20	\$14.89

Lifespan

You are essentially resetting the life of your luminaire with new components and warranty on your retrofit kit. This is a superior choice to led tubes as this method of retrofitting does not reset the life of your ballast nor sockets (potentially adding additional component and labor costs).

DLC (Design-Lights Consortium®) qualified products. Please visit www.designlights.org/GPL to verify the latest update of the DLC Qualified Products List and validate which ones are qualified. Some restrictions may apply.

RETROFIT OPTION 1



Please follow the 2 steps below to determine which retrofit kit is compatible with your luminaire

1. Is your existing fixture one of the following brands and models?

Compatible and Certified to following fluorescent models:

Manufacturer	Series
AIMLITE	VP4
STANPRO	VT4
STANDARD	FPV
RAB	FW4
LITELINE	EGF
BEGHELLI	BS100
THOMAS AND BETTS	Fluorescent sub-brands
EMERGI-LITE	IPE
LUMACELL	IPL
READYLITE	IPR

2. Does your existing fluorescent fixture look like the following?

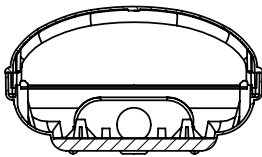

WHITE FLAT PAN

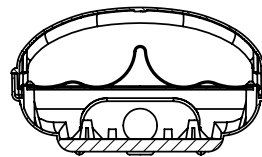

SILVER GULLWING OVER A FLAT PAN

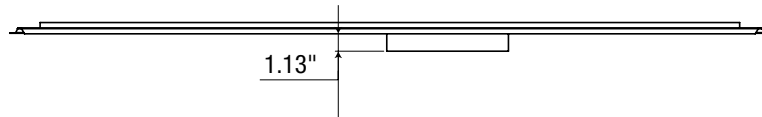
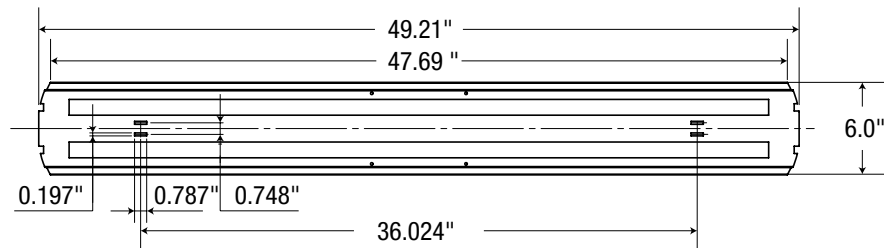
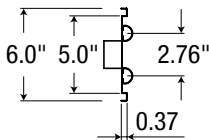

ORDERING GUIDE

Part Number	Wattage	Estimated Lumens*	Voitage	Colour temperature	Stocking SKU	Compatibility
RETVP-40W-MC-2/40K	41W	5000	120-277V	4000K	✓	WHITE FLAT PAN and SILVER GULLWING over FLAT PAN
RETVP-40W-MC-8/40K	40W	4700	347V	4000K	✓	WHITE FLAT PAN and SILVER GULLWING over FLAT PAN

* Please refer to IES files for accurate photometric data representation of a retrofit installed in a vapourtight luminaire with clear lens

RETROFIT OPTION 2

ecofit

Please follow the 2 steps below to determine which retrofit kit is compatible with your luminaire

1. Is your existing fixture one of the following brands and models?

Compatible and Certified to following fluorescent models:

Manufacturer	Luminaire
AIMLITE	VP4
STANPRO	VT4

2. Does your existing fluorescent fixture look like the following?

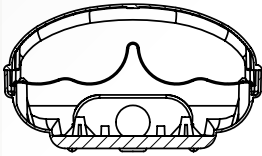

WHITE GULLWING ONLY

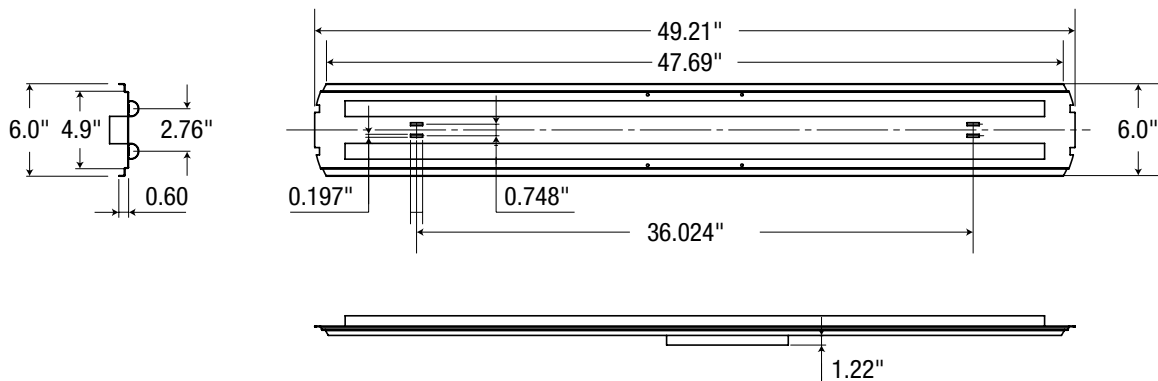

ORDERING GUIDE

Part Number	Wattage	Estimated Lumens*	Voltage	Colour temperature	Stocking SKU	Compatibility
RETVP-40W-PC-2/40K	41W	5000	120-277V	4000K	✓	WHITE GULLWING WITH NO FLAT PAN
RETVP-40W-PC-8/40K	40W	4700	347V	4000K	✓	WHITE GULLWING WITH NO FLAT PAN

* Please refer to IES files for accurate photometric data representation of a retrofit installed in a vapourtight luminaire with clear lens

EASE OF INSTALLATION – IN 5 MINUTES!!

ecofit

STEP 1

remove lens



STEP 2

remove the fluorescent tubes



STEP 3

Remove fluorescent gear tray and existing wiring connections



STEP 4

Make wiring connections and install LED gear tray



STEP 5

Re-install the lens



Retrofitting an existing fixture can easily save 70% to 80% installation time when compared to installing a new LED fixture depending on type of mounting and application environment (customer must not only consider installation time of a new fixture but also removal time required of an existing fixture).

Meaning it will easily take 45-60mins per fixture if not more to remove and then re-install the new fixture.